

**Bloomington Historic Preservation Commission Showers City Hall  
McCloskey Room, Thursday September 27, 2018, 5:00 P.M.  
AGENDA**

**I. CALL TO ORDER**

**II. ROLL CALL**

**III. APPROVAL OF MINUTES**

A. September 13, 2018 Minutes

**IV. CERTIFICATES OF APPROPRIATENESS**

Commission Review

**A. COA 18-64**

1018 E. 1<sup>st</sup> Street

Petitioner: Scott Libson and Dorothy Rhodes

Addition of five fly rafter braces on the east and west sides of the house to support overhangs of extension. Braces are wood.

**B. COA 18-65**

1109 E. Hunter

Petitioner: Chris Sturbaum (Golden Hands Construction)

Replacement of windows and door of sunroom (rear of house). Proposed windows are Marvin casements with wood interior grills. Replacement door is in kind metal or fiberglass.

**C. COA 18-66**

720 W. 3<sup>rd</sup> Street

Petitioner: Chris Sturbaum (Golden Hands Construction)

Substantial interior remodel will result in window and door changes at rear of home, in addition to smaller windows for bath and kitchen areas. Marvin "Integrity" double-hung windows (x7). Movement of rear backdoor to east.

**D. COA 18-67**

402 S. Rogers

Petitioner: Chris Sturbaum (Golden Hands Construction)

Replace existing vinyl windows with Marvin "Integrity" windows. Build screen porch with traditional rail and spindles on southwest corner of house. Restore the west exterior wall with wood and replacement of damaged siding.

**E. COA 18-68**

201 E. State Road 45/46 Bypass

Petitioner: Derk Brewer

Attach lumber and vinyl garage to rear of existing home.

**F. COA 18-50 (amendment)**

210 E. Gilbert Drive

Petitioner: Russ Herndon (Loren Wood Builders)

Change to a freestanding detached pool structure in rear.

**G. COA 18-69**

515 W. 3<sup>rd</sup> Street

Petitioner: Charles and Patricia Russo

New exterior paint for home and garage.

**H. COA 18-70**

204 S. Rogers Street

Petitioner: Paul Muzzello

Stained wood fence enclosure for trash and electrical panels on north side of building.

**V. DEMOLITION DELAY**

Commission Review

**A. Demo Delay 18-36**

910 N. College Avenue

Petitioner: Jeff Fanyo (Bynum Fanyo and Associates, Inc.)

Full demolition of structure.

- VI. OLD BUSINESS**
  - A. Rules, Ethics
  - B. Retreat
  - C. Demolition Delay Clarification
- VII. COMMISSIONER COMMENTS**
- VIII. PUBLIC COMMENTS**
- IX. ANNOUNCEMENTS**
- X. ADJOURNMENT**

*Auxiliary aids for people with disabilities are available upon request with adequate notice. Please call 812-349-3429 or email, [human.rights@bloomington.in.gov](mailto:human.rights@bloomington.in.gov).*  
Next meeting date is October 11, 2018, at 5:00 P.M. in the McCloskey Room. **Posted: 9/20/2018**

**Bloomington Historic Preservation Commission  
Showers City Hall McCloskey Room,  
Thursday September 13, 2018, 5:00 P.M.  
MINUTES**

**I. CALL TO ORDER**

Meeting was called to order at 5:07 pm.

**Note: Due to not having quorum at the beginning of the meeting, the agenda did not follow order. Deb Hutton arrived at 5:35 pm.**

**II. CERTIFICATES OF APPROPRIATENESS**

**Staff Review**

**A. COA 18-63**

512 S. Hawthorne Drive  
Petitioner: Barre Klapper (Springpoint Architects)  
Change in stair location and scope.

**Doris Sims** gave presentation. See packet for details.

**III. NEW BUSINESS**

**A. Local Architecture Speaker Request**

**Doris Sims** announced an Indiana University Women's group is requesting a speaker to present different types of historic buildings and architecture in the Bloomington area. The commission nominated Duncan Campbell if he is available. **Doris Sims** stated Derek Richey had a presentation at the retreat last year as well. She stated Eric Sader would contact them.

**B. Hiring Announcement**

**Doris Sims** announced the new hire for the Historic Preservation Program Manager, Conor Herterich. His first day of work will be September 24, 2018.

**IV. OLD BUSINESS**

**A. Opposition to 1209 W. 2nd Demolition Voiced**

**Doris Sims** stated the HAND department received a phone call from a citizen voicing their concern and opposition about the demolition of 1209 W. 2<sup>nd</sup> Street.

**B. Commission Rules and Code of Ethics**

**Doris Sims** stated there is a revised copy of the Commission Rules in the packet. There is also a red-lined version so the commissioners can see the changes. It was requested the commissioners review the revised rules and code of ethics so they can be adopted at a future meeting.

**John Saunders** commented it seems as if the Vice Chair has a lot of responsibilities. **Doris Sims** reminded John that the rules also state, "with the assistance of HAND staff," which includes herself, Eric Sader, Alison Kimmel and the Program Manager.

**Chris Sturbaum** commented he would like to see if it is possible to do a consent agenda for all staff reviews. He thinks staff would approve more COA's on staff level with this process. **Doris Sims** stated staff would look in to it. **Anahit Behjou** stated it also needs to be reviewed to make sure it follows state law.

### C. Demolition Delay Clarification

**Doris Sims** tabled this item until the next meeting. Corporation Council, Philippa Guthrie, was not present at this meeting to clarify the Demolition Delay process.

## V. COMMISSIONER COMMENTS

**Flavia Burrell** stated whatever changes the commission makes, she wants to make it easier and expedient for the public. The more staff approvals the better.

**Chris Sturbaum** stated he would like to have a retreat sooner rather than later with the new staff person. This would be a good opportunity to allow staff to get to know the commissioners. **Doris Sims** stated we plan on hosting a commission retreat in October.

## VI. PUBLIC COMMENTS

NONE.

The meeting took a 10 minute intermission.

## VII. ROLL CALL

### **Commissioners**

Chris Sturbaum

Lee Sandweiss

Flavia Burrell

John Saunders

Deb Hutton – arrived at 5:35 pm.

### **Staff**

Alison Kimmel – HAND

Doris Sims – HAND

Jackie Scanlan – Planning & Transportation

Anahit Behjou – Legal

### **Guests**

Victoria Thevenon

Cameron DeVoe

Ty Henderson

Matt Oman

Jeff Fanyo

Tim Henke

Matt Ellenwood

## **VII. CERTIFICATES OF APPROPRIATENESS**

### **Commission Review**

#### **A. COA 18-60 (Amended)**

102 E. 17th Street

Petitioner: Matt Ellenwood (Matte Black Architecture)

Revised home enhancements.

**Doris Sims** gave presentation. See packet for details.

**Matt Ellenwood** stated they have updated the plans for the house. The windows specifications are in the packet and the front porch details have been submitted. He stated they are not replacing the windows with wood because that would include removing the trim and possibly some of the siding.

**Tim Henke** stated he did a lot of research on the house and found it is defined as a massed-plan minimalist house. There are a lot of these houses in the neighborhood, but most of them have more details than this house. He stated they are keeping the chimney since it is the only ornamentation this house has. The front porch is limestone slab. He described it as a frail and delicate house. He stated the windows are not safe. Replacing the windows is the most pressing issue.

**Chris Sturbaum** asked if anything was changing with the front door. **Tim Henke** stated it is staying as-is.

**Doris Sims** commented there was no feedback from the neighborhood.

**Chris Sturbaum** stated he is fine with the argument to replace the windows. He also wanted to commend the petitioner on the research he did.

**Deb Hutton** wanted to thank the petitioner for wanting to keep the chimney.

**Chris Sturbaum** made a motion to approve **COA 18-60**, as amended. **Lee Sandweiss** seconded. **Motion carried 5/0/0.**

## **VIII. APPROVAL OF MINUTES**

A. August 9, 2018

B. August 23, 2018

**Deb Hutton** made a motion to approve minutes from August 9, 2018 and August 23, 2018.

**Chris Sturbaum** seconded. **Motion carried 5/0/0.**

## **V. DEMOLITION DELAY**

### **Commission Review**

#### **A. Demo Delay 18-34**

2420 W. 3rd Street  
Petitioner: Daniel Butler (Bynum Fanyo and Associates, Inc.)  
Full demolition of three structures.

**Doris Sims** gave presentation. See packet for details.

**Jeff Fanyo** stated the building has no roof and is not a sound structure, therefore they're requesting demolition.

**Chris Sturbaum** stated he does not love this building.

**John Saunders** made a motion to release **Demo Delay 18-34**. **Chris Sturbaum** seconded.  
**Motion carried 5/0/0.**

**B. Demo Delay 18-35**

615 S. Adams Street  
Petitioner: Matt Oman (RQAW)  
Full demolition of one structure.

**Doris Sims** gave presentation. See packet for details.

**Chris Sturbaum** asked what the context of the area is. **Matt Oman**, project manager, and **Victoria Thevenon**, Executive director of Monroe County Youth Services Bureau, introduced themselves. **Victoria Thevenon** stated the house they are asking to be demolished, needs completely remodeled. The house leaks and the staff no-longer feel safe working in the building.

**John Saunders** asked if they had researched the building being moved. **Victoria Thevenon** stated they had not, however, Weddle Bros. construction gave them an estimate for what it would cost to fix the house and it was not feasible for them.

**John Saunders** made a motion to release **Demo Delay 18-35**. **Lee Sandweiss** seconded. **Motion carried 5/0/0.**

**X. ANNOUNCEMENTS**

NONE

**XI. ADJOURNMENT**

Meeting was adjourned at 6:20 pm.

SUMMARY

COA 18-64

1018 E. 1<sup>st</sup> Street – Elm Heights  
Petitioner: Scott Libson and Dorothy Rhodes

Contributing

105-055-47037

C. 1928



*Background:* Historically known as the John and Gertrude Gillum House, this property contains a good unaltered American foursquare home of wood walls with limestone foundation.

*Request:* Addition of five fly rafter braces on the east and west sides of the house to support overhangs of extension. Braces are wood.

*Guidelines:*

***Secretary of the Interior's Standards for Rehabilitation:***

Standard 9: New additions, exterior alterations or related new construction will not destroy historic materials, features and spatial relationships that characterize the property. The new work will be differentiated from the old and will be compatible with the historic materials, features,

size, scale and proportion, and massing to protect the integrity of the property and its environment.

### ***Local Historic District Design Guidelines***

#### **4.4 Roofs**

1. To ensure the structural soundness of the building by preventing moisture damage.
2. To retain and restore original roofs and special features, such as unique materials, cresting, box gutters, dormers, cornices, cupolas, and chimneys where they are significant to the design of the building, through routine maintenance and repairs.
- I4. When attempting to introduce new roof features such as skylights, dormers, or vents, locate them so as to minimize damage to the historic roof design, character-defining roof materials, or the character of the historic district.

*Recommendations:* Staff recommends approval of COA 18-64. Staff does have concern that the original roofline did not have visible rafter bracing and would prefer a less visible approach to support if available. However, guidelines support structural soundness of roofs, and this would certainly aid to that degree. In addition, though the example provided by petitioner of a neighboring roof with braces is not of the same architectural style of home, a sampling of American foursquare roofs researched independently indicate visible bracing to not be uncommon.



APPLICATION FORM  
CERTIFICATE OF APPROPRIATENESS

Case Number: 18-64

Date Filed: Sep. 6. 2018

Scheduled for Hearing: 9-27-2018

RECEIVED  
SEP 10 2018

BY: AAK

\*\*\*\*\*

Address of Historic Property: 1018 E 1st St

Petitioner's Name: Scott Libson and Dorothy Rhodes

Petitioner's Address: 1018 E 1st St

Phone Number/e-mail: 917-751-1312; scott.libson@gmail.com

Owner's Name: Scott Libson and Dorothy Rhodes

Owner's Address: 1018 E 1st St

Phone Number/e-mail: 917-751-1312; scott.libson@gmail.com

Instructions to Petitioners

The petitioner must attend a preliminary meeting with staff of the Department of Housing and Neighborhood Development during which the petitioner will be advised as to the appropriateness of the request and the process of obtaining a Certificate of Appropriateness. The petitioner must file a "complete application" with Housing and Neighborhood Department Staff no later than seven days before a scheduled regular meeting. The Historic Preservation Commission meets the second Thursday of each month at 5:00 P.M. in the McCloskey Room. The petitioner or his designee must attend the scheduled meeting in order to answer any questions or supply supporting material. You will be notified of the Commission's decision and a Certificate of Appropriateness will be issued to you. Copies of the Certificate must accompany any building permit application subsequently filed for the work described. If you feel uncertain of the merits of your petition, you also have the right to attend a preliminary hearing, which will allow you to discuss the proposal with the Commission before the hearing during which action is taken. Action on a filing must occur within thirty days of the filing date, unless a preliminary hearing is requested.

**Please respond to the following questions and attach additional pages for photographs, drawings, surveys as requested.**

A **“Complete Application”** consists of the following:

1. A legal description of the lot. Part of lot 104 in Seminary; Parcel 53-08-04-100-038.000-009
  
2. A description of the nature of the proposed modifications or new construction:  
Addition of five fly rafter braces on the east and west sides of the house. Their primary function is to support overhangs in the back of the house, accomplished by one or two of the braces on each side.  
The additional braces are for aesthetic consistency. When the previous owners extended the house (ca. 1980), the builders used plywood for the overhangs. These overhangs are now sagging and the home inspector deemed them unsafe even to examine closely. The braces will match those on the neighboring house at 1014 E 1st St (listed as notable).
  
3. A description of the materials used.  
Wood and wood screws.
  
4. Attach a drawing or provide a picture of the proposed modifications. You may use manufacturer’s brochures if appropriate.
  
5. Include a scaled drawing, survey or geographic information system map showing the footprint of the existing structure and adjacent thoroughfares, Geographic Information System maps may be provided by staff if requested. Show this document to Planning Department Staff in order to ascertain whether variances or zoning actions are required.
  
6. Affix at least three photographs showing the existing full facade at each street frontage and the area of modification. If this petition is a proposal for construction of an entirely new structure or accessory building, include photographs of adjacent properties taken from the street exposure.

\*\*\*\*\*

If this application is part of a further submittal to the Board of Zoning Appeals for a Conditional Use or development standard variance, please describe the use proposed and modification to the property which will result.

1018 E 1st St

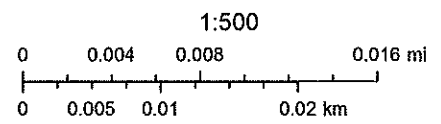

Braces on House of Neighbor (1014 E 1st St)

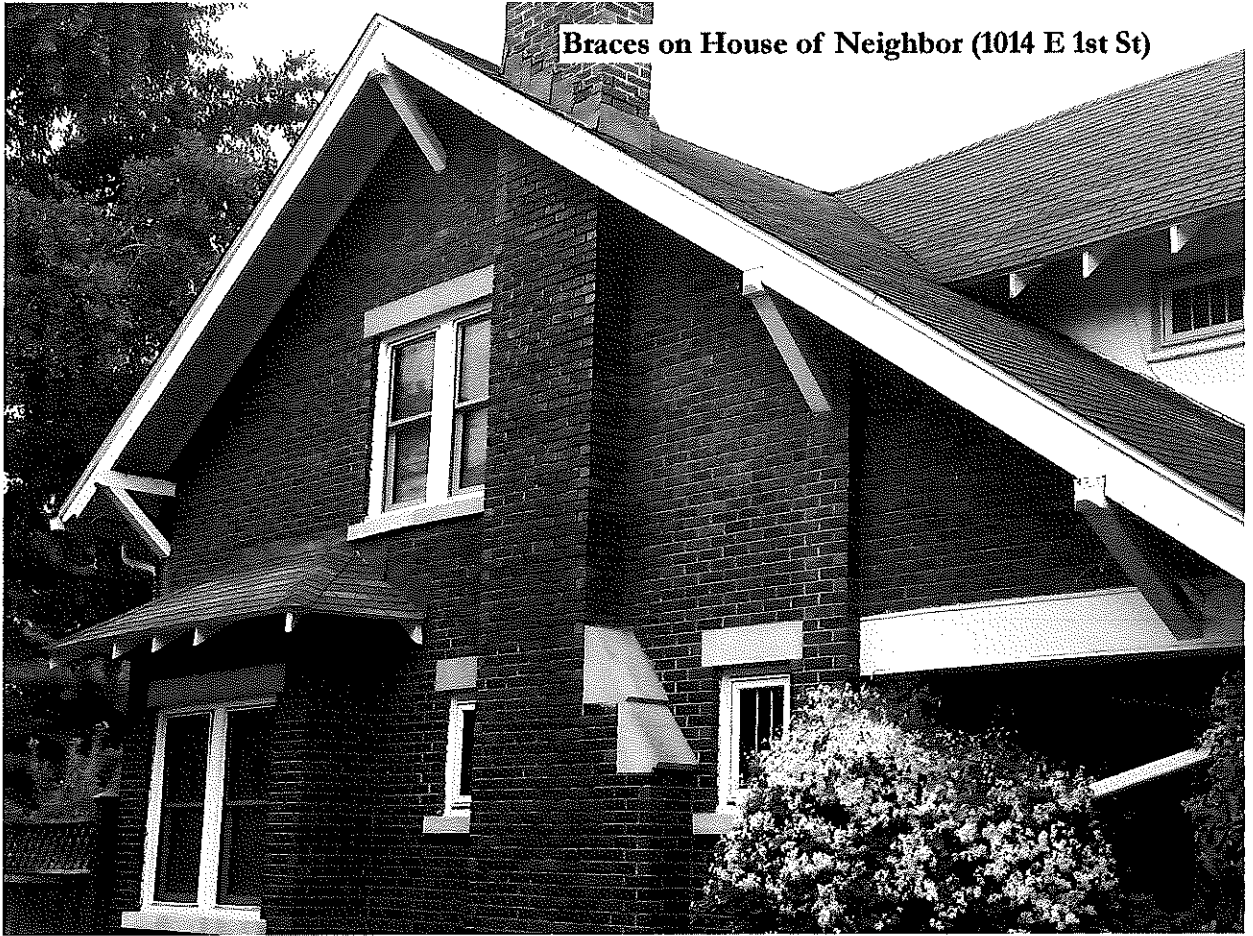

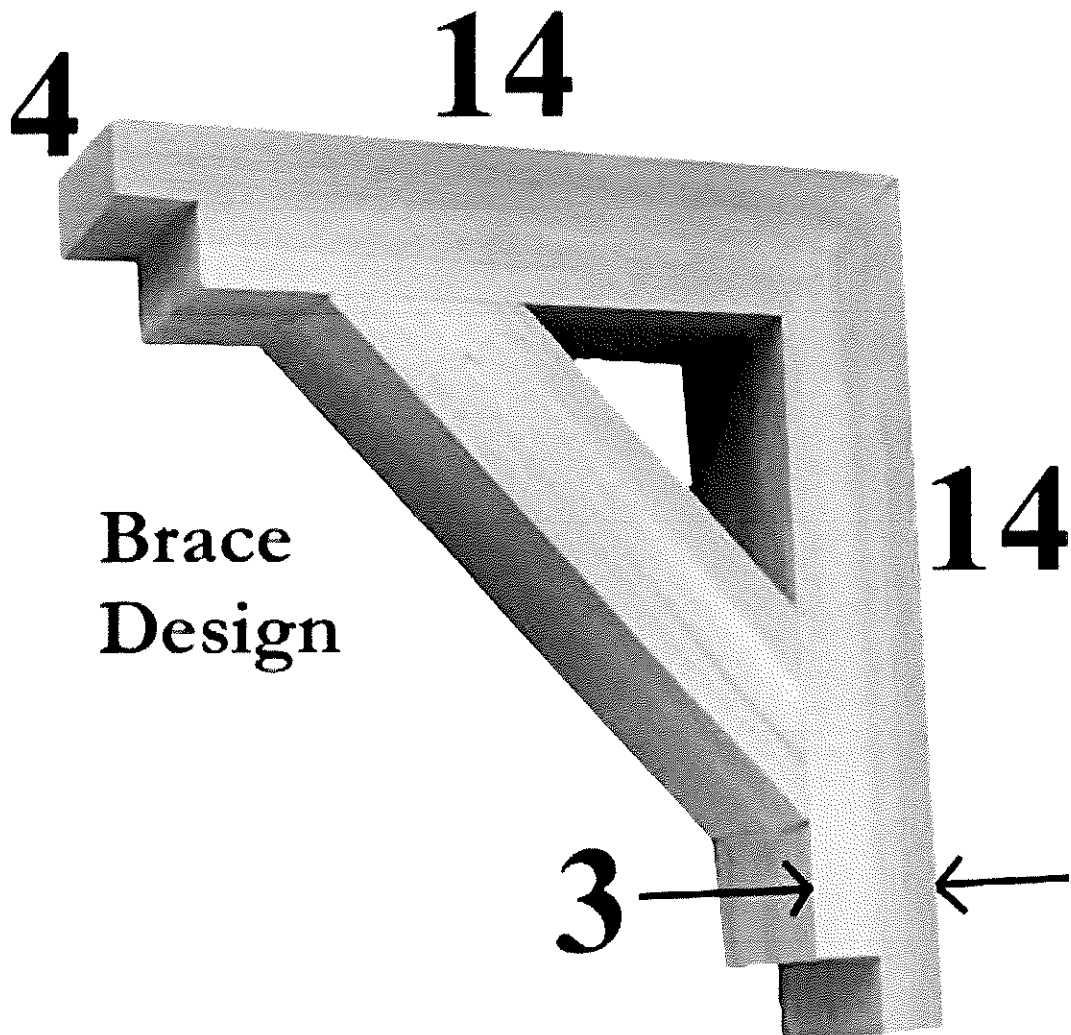

Brace  
Design

**View of Western Side of House**

Approximate location of braces

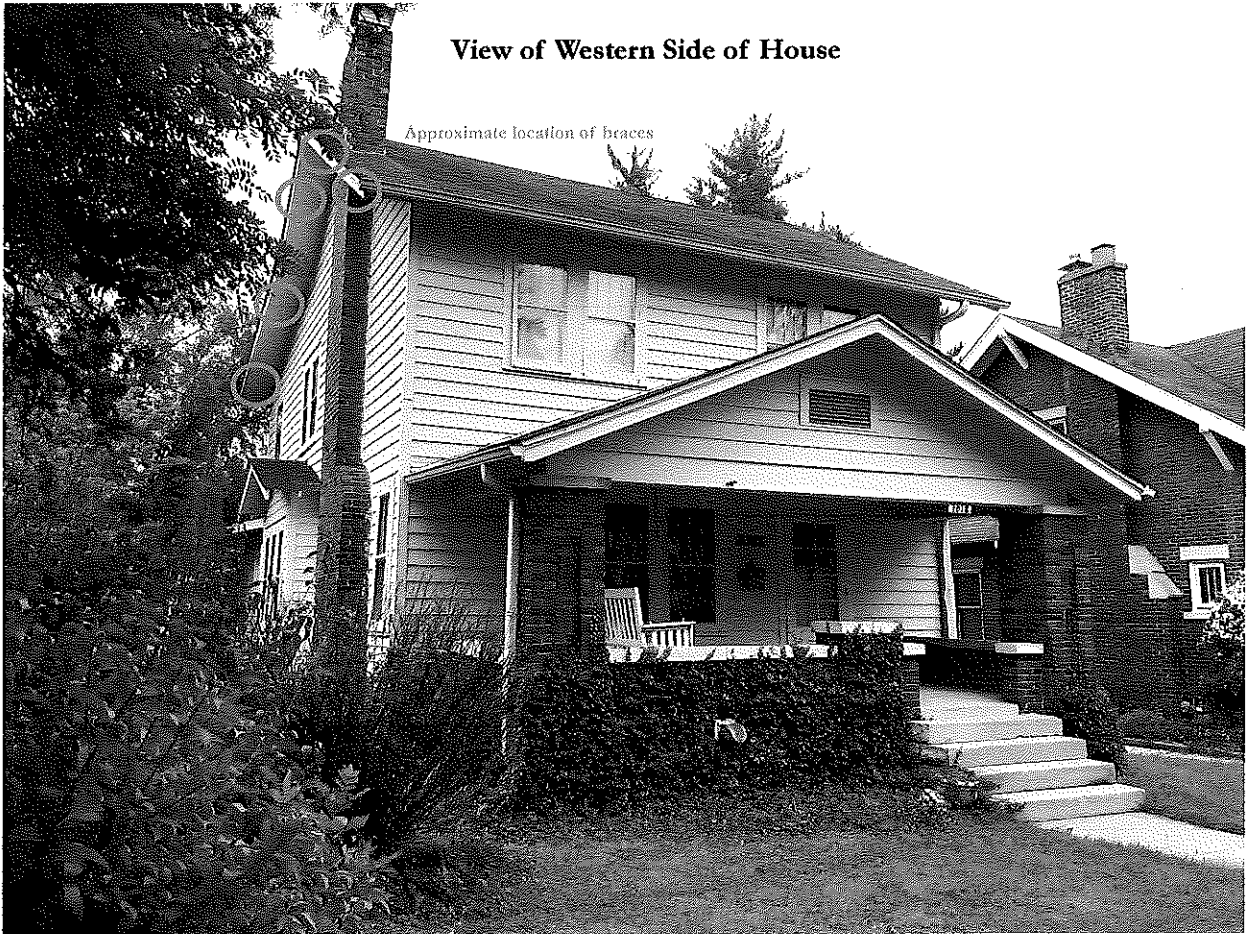

Transition from Original to New Roof

**View of Eastern Side of House**

Approximate location of braces

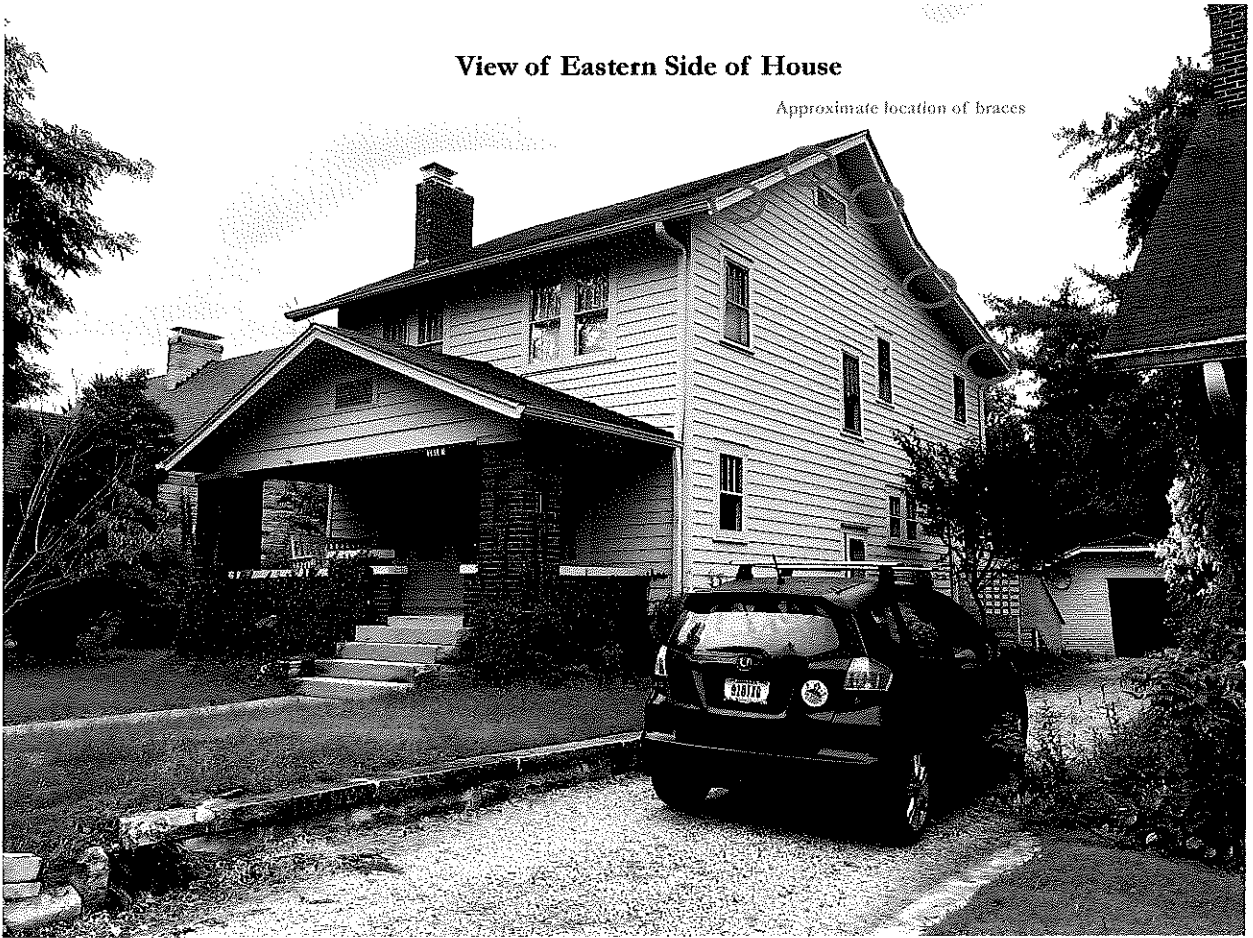

**View of Front of House**

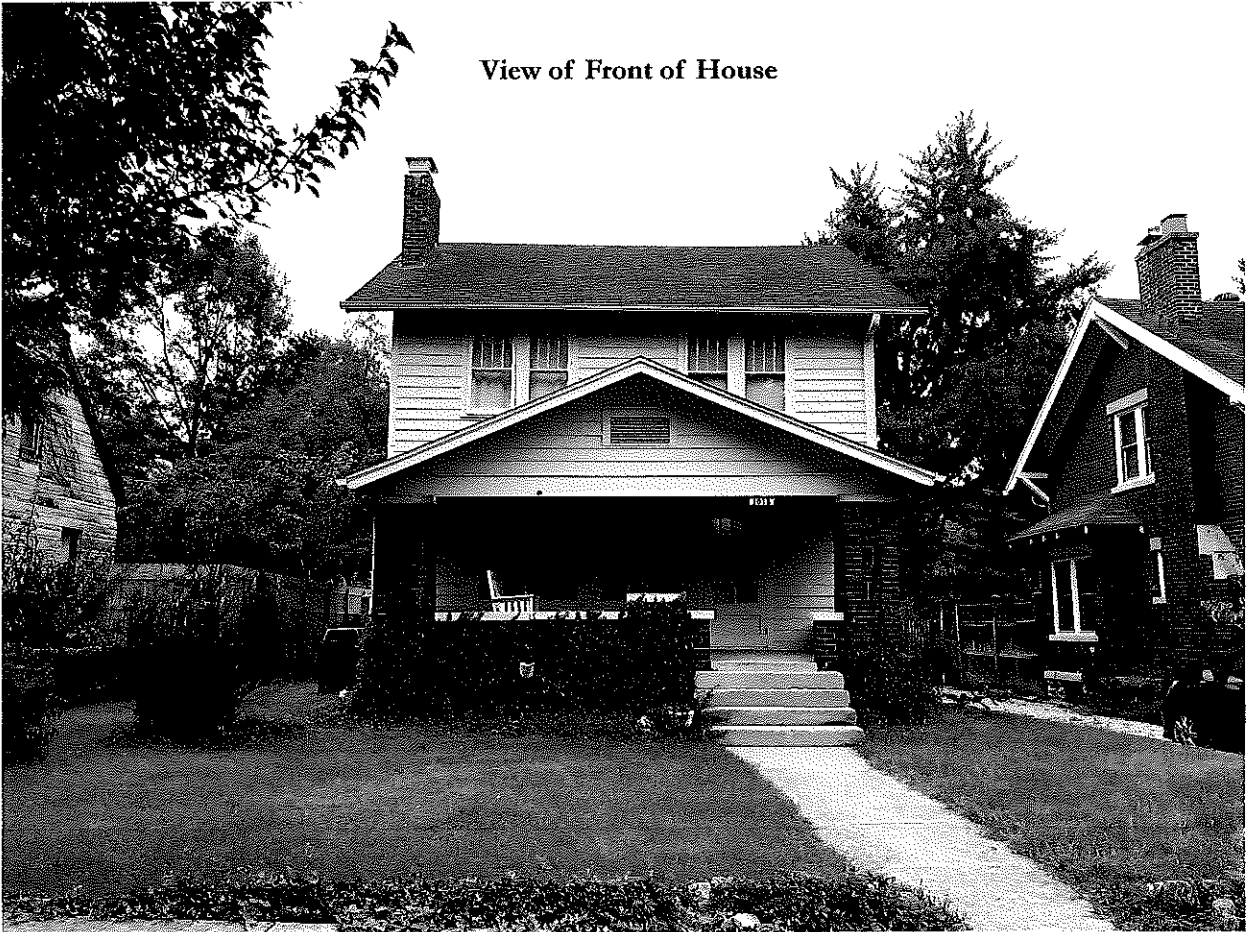

SUMMARY

COA 18-65

1109 E. Hunter – Elm Heights  
Petitioner: Chris Sturbaum (Golden Hands Construction)

Contributing

105-055-51288

C. 1940



*Background:* Slightly altered English Cottage in good condition, of brick and vinyl walled construction, with limestone foundation.

*Request:* Replacement of windows and door of sunroom (rear of house). Proposed windows are Marvin casements with wood interior grills. Replacement door is in kind metal or fiberglass.

*Guidelines:*

***Secretary of the Interior's Standards for Rehabilitation:***

Standard 2: The historic character of a property will be retained and preserved. The removal of distinctive materials or alteration of features, spaces and spatial relationships that characterize a property will be avoided.



Standard 9: New additions, exterior alterations or related new construction will not destroy historic materials, features and spatial relationships that characterize the property. The new work will be differentiated from the old and will be compatible with the historic materials, features, size, scale and proportion, and massing to protect the integrity of the property and its environment.

***Local Historic District Design Guidelines***

**Guidelines for Windows and Doors**

- \*If original windows, doors, and hardware can be restored and reused, they should not be replaced.
- \*Consider salvage or custom-made windows or doors to ensure compatibility with original openings and style.
- \*Inappropriate treatment of windows and doors, particularly in the primary facades, include: d) addition of cosmetic detailing that creates a style or appearance that the original building never exhibited.
- \*Wood-frame storm windows and doors are the most historically preferred option . . . All should be finished to match the trim or be as complementary in color to the building as possible.

*Recommendations:* Staff recommends approval of COA 18-65. Visibility is minimal only from S. Ballantine Road and rear alleyway, and work does not appear likely to be seen from the main street. Guideline emphasis is on primary façade. Proposed windows appear to be more in line (at least as to material) with historically preferred options for the district. Door is said not to be substantially different than the existing.

**APPLICATION FORM  
CERTIFICATE OF APPROPRIATENESS**

Case Number: 18-65

Date Filed: 9/11/18

Scheduled for Hearing: Sep 27

\*\*\*\*\*

Address of Historic Property: 1109 E Hunter

Petitioner's Name: Chris Sturbaum / Golden Hands Construction

Petitioner's Address: 334 S Jackson

Phone Number/e-mail: 812-336-9171

Owner's Name: Martha Harsanyi

Owner's Address: 1109 E Hunter

Phone Number/e-mail: 812 336-1333

**Instructions to Petitioners**

The petitioner must attend a preliminary meeting with staff of the Department of Housing and Neighborhood Development during which the petitioner will be advised as to the appropriateness of the request and the process of obtaining a Certificate of Appropriateness. The petitioner must file a "complete application" with Housing and Neighborhood Department Staff no later than seven days before a scheduled regular meeting. The Historic Preservation Commission meets the second Thursday of each month at 5:00 P.M. in the McCloskey Room. The petitioner or his designee must attend the scheduled meeting in order to answer any questions or supply supporting material. You will be notified of the Commission's decision and a Certificate of Appropriateness will be issued to you. Copies of the Certificate must accompany any building permit application subsequently filed for the work described. If you feel uncertain of the merits of your petition, you also have the right to attend a preliminary hearing, which will allow you to discuss the proposal with the Commission before the hearing during which action is taken. Action on a filing must occur within thirty days of the filing date, unless a preliminary hearing is requested.

Please respond to the following questions and attach additional pages for photographs, drawings, surveys as requested.

A "Complete Application" consists of the following:

1. A legal description of the lot. \_\_\_\_\_

2. A description of the nature of the proposed modifications or new construction:

Replace Windows on Sun room  
and Door. Sunroom is on back of  
house 32x60 pairs (3) 32x60 (1)

3. A description of the materials used.

Marvin Casements w <sup>Wood</sup> Interior Grills  
Replace Exterior Door In kind  
15 lite metal or fiberglass door.

4. Attach a drawing or provide a picture of the proposed modifications. You may use manufacturer's brochures if appropriate.

5. Include a scaled drawing, survey or geographic information system map showing the footprint of the existing structure and adjacent thoroughfares, Geographic Information System maps may be provided by staff if requested. Show this document to Planning Department Staff in order to ascertain whether variances or zoning actions are required.

6. Affix at least three photographs showing the existing full facade at each street frontage and the area of modification. If this petition is a proposal for construction of an entirely new structure or accessory building, include photographs of adjacent properties taken from the street exposure.

\*\*\*\*\*

If this application is part of a further submittal to the Board of Zoning Appeals for a Conditional Use or development standard variance, please describe the use proposed and modification to the property which will result.

Alley

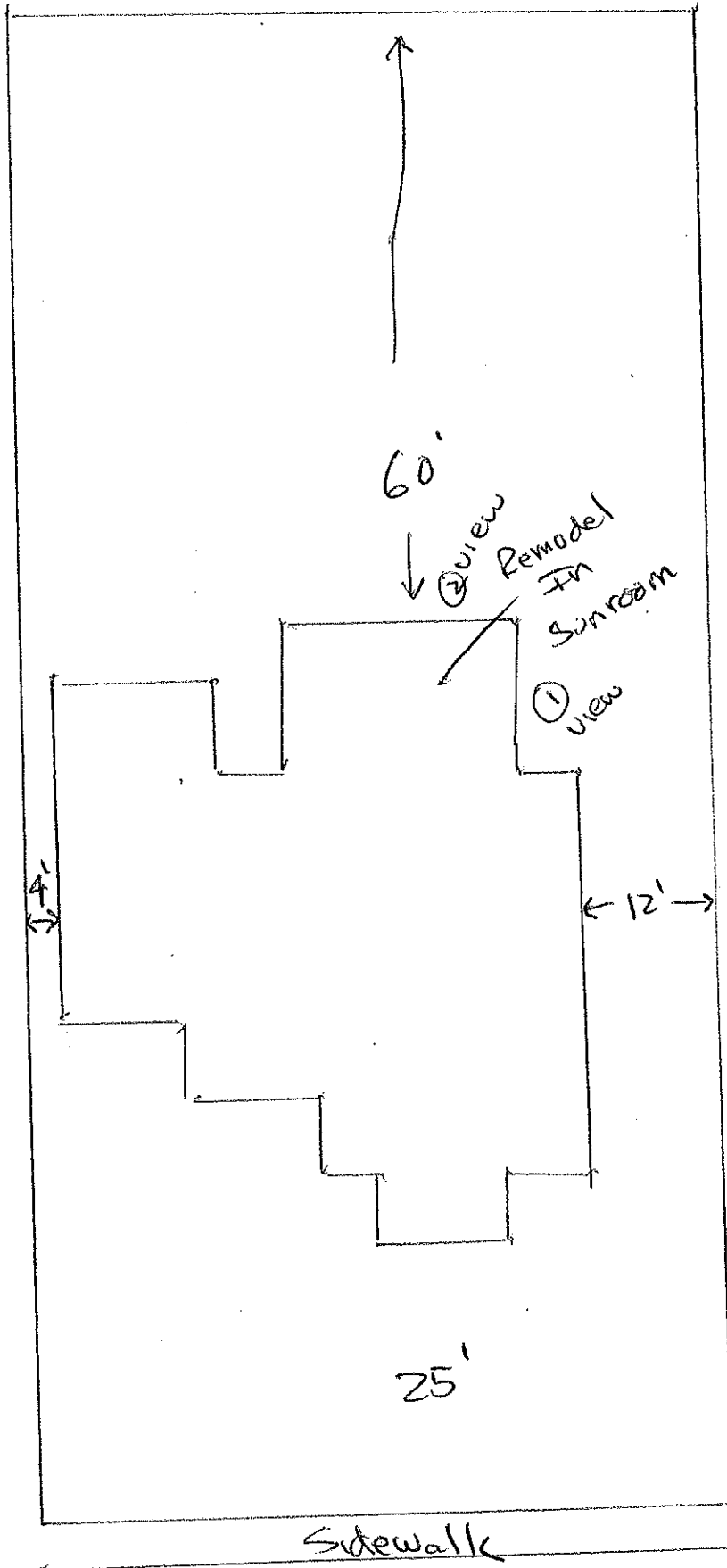



1109 F Hunter Front View



Before ①

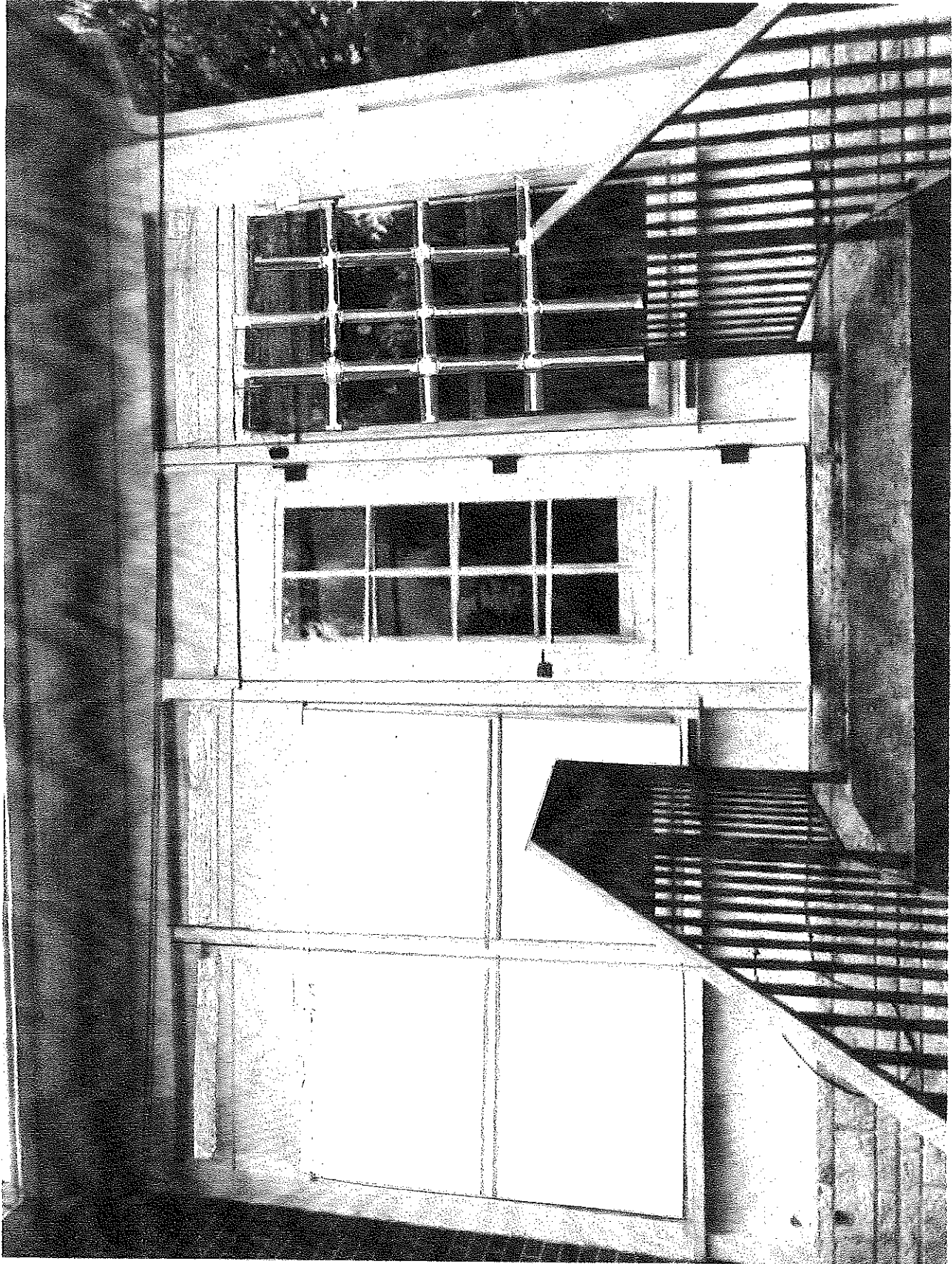

After ①

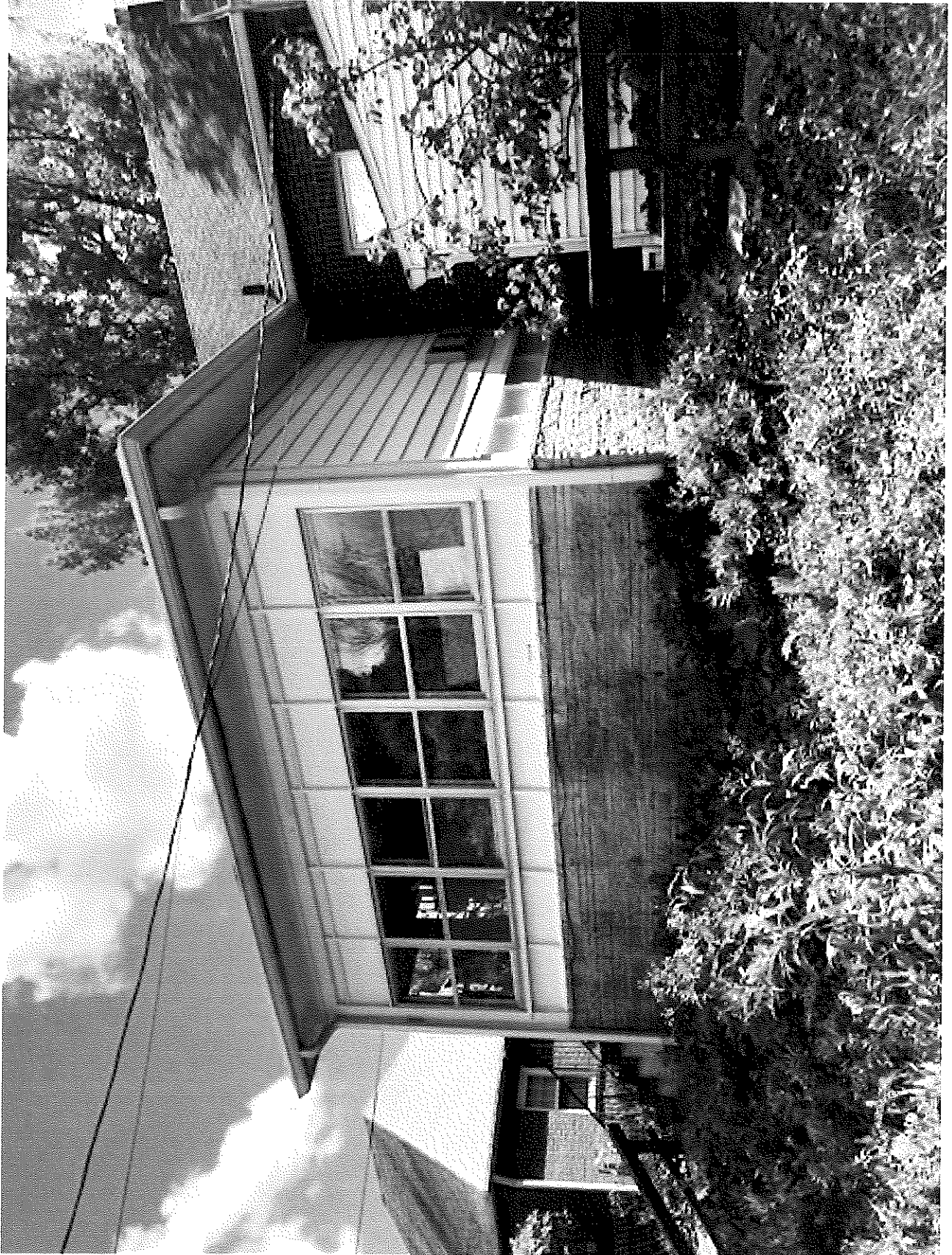

Before ②





After ②

**LINE ITEM QUOTES**

The following is a schedule of the windows and doors for this project. For additional unit details, please see Line Item Quotes. Additional charges, tax or Terms and Conditions may apply. Detail pricing is per unit.

Line #1	Mark Unit: 3260 TWIN CASEMENTS	Net Price:	1,022.97
Qty: 3		Ext. Net Price:	3,068.91
		USD	

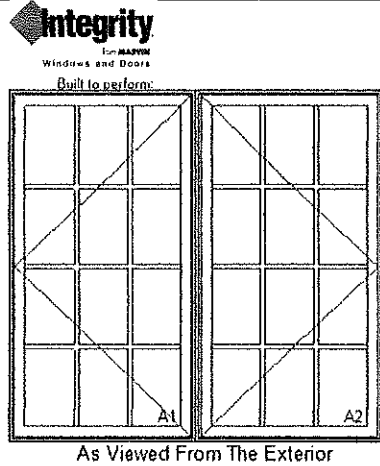

- Stone White Exterior
- White Interior ..... 77.40
- 2W1H - Rectangle Assembly
- Assembly Rough Opening
- 65" X 59 5/8"
  
- Unit: A1 ..... 394.74
- Integrity Casement - Left Hand
- Wood-Ultrex
- CN 3359
- Rough Opening 33" X 59 5/8"
- IG - 1 Lite
- Low E2 w/Argon
- 3/4" Grille ..... 46.44
- Rectangular - Standard Cut 3W4H
- White Finish
- White Folding Handle
- Interior Aluminum Screen ..... 18.06
- Charcoal Fiberglass Mesh
- White Surround
  
- Unit: A2 ..... 394.74
- Integrity Casement - Right Hand
- Wood-Ultrex
- CN 3359
- Rough Opening 33" X 59 5/8"
- IG - 1 Lite
- Low E2 w/Argon
- 3/4" Grille ..... 46.44
- Rectangular - Standard Cut 3W4H
- White Finish
- White Folding Handle
- Interior Aluminum Screen ..... 18.06
- Charcoal Fiberglass Mesh
- White Surround
- 4 9/16" Jamb
- Nailing Fin w/ Certification Brackets ..... 27.09
- \*\*\*Note: This configuration is certified to AAMA 450.
- \*\*\*Note: Divided lite cut alignment may not be accurately represented in the OMS drawing. Please consult your local representative for exact specifications.

Line #2	Mark Unit: 3260 SINGLE CASEMENT	Net Price:	497.94
Qty: 1		Ext. Net Price:	497.94
		USD	

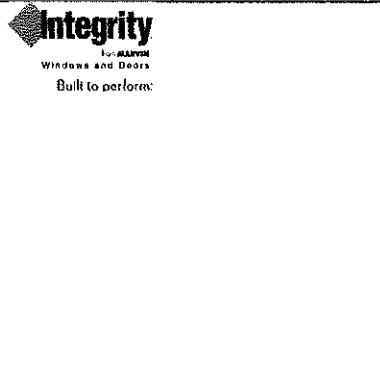

- Stone White Exterior
- White Interior ..... 38.70
- Integrity Casement - Left Hand ..... 394.74
- Wood-Ultrex
- CN 3359
- Rough Opening 33" X 59 5/8"
- IG - 1 Lite
- Low E2 w/Argon
- 3/4" Grille ..... 46.44
- Rectangular - Standard Cut 3W4H
- White Finish
- White Folding Handle
- Interior Aluminum Screen ..... 18.06
- Charcoal Fiberglass Mesh
- White Surround
- 4 9/16" Jamb
- Nailing Fin

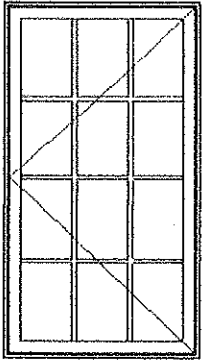

As Viewed From The  
Exterior

CN 3359

\*\*\*Note: Divided lite cut alignment may not be accurately represented in the OMS drawing. Please consult your local representative for exact specifications.

Project Subtotal Net Price: USD	3,566.85
7.000% Sales Tax: USD	249.68
Project Total Net Price: USD	3,816.53

## SUMMARY

COA 18-66

720 W. 3rd – Greater Prospect Hill  
Petitioner: Chris Sturbaum (Golden Hands Construction)

Contributing

105-055-54001

C. 1900



*Background:* Severely altered pyramid roof cottage in good condition. SHAARD indicates current one-over-one wood sash windows with modern storm windows.

*Request:* Substantial interior remodel will result in window and door changes at rear of home, in addition to smaller windows for bath and kitchen areas. Marvin “Integrity” double-hung windows (x7). Movement of rear backdoor to east.

*Guidelines:*

***Secretary of the Interior’s Standards for Rehabilitation:***

Standard 2: The historic character of a property will be retained and preserved. The removal of distinctive materials or alteration of features, spaces and spatial relationships that characterize a property will be avoided.

Standard 9: New additions, exterior alterations or related new construction will not destroy historic materials, features and spatial relationships that characterize the property. The new work will be differentiated from the old and will be compatible with the historic materials, features, size, scale and proportion, and massing to protect the integrity of the property and its environment.

***Local Historic District Design Guidelines***

Fenestration

1. Creative expression with fenestration is not precluded provided the result does not conflict with or draw attention from surrounding historic buildings.
2. Windows and doors should be arranged on the building so as not to conflict with the basic fenestration pattern in the area.
4. Window openings should reflect the basic proportionality and directionality of those typically found on surrounding historic buildings.

*Recommendations:* Staff recommends approval of COA 18-66. Staff recognizes substantial alterations to the openings in the home are occurring and finds this unideal. However, changes are primarily only alley-visible. Staff's concerns apply even less to the window changes on the west side of the home, even if including a smaller less common bathroom window for the area, due to visibility impairment by all other than the adjoining neighbor. Proposed windows and openings are compatible with district design guidelines as maintain the same basic proportions of glass, general window patterns of the area, and overall will not be distracting. The home is currently classified as severely altered.

**APPLICATION FORM  
CERTIFICATE OF APPROPRIATENESS**

Case Number: 18-66

Date Filed: 9/11/18

Scheduled for Hearing: Sep 27

\*\*\*\*\*

Address of Historic Property: 720 W. 3rd

Petitioner's Name: Chris Sturbaum / Golden Hands Construction

Petitioner's Address: 334 S Jackson

Phone Number/e-mail: 812 336-9171 / 812-340-0724

Owner's Name: Richard Lewis Don Harp

Owner's Address: 720 W 3rd

Phone Number/e-mail: 917-449-5284

Instructions to Petitioners

The petitioner must attend a preliminary meeting with staff of the Department of Housing and Neighborhood Development during which the petitioner will be advised as to the appropriateness of the request and the process of obtaining a Certificate of Appropriateness. The petitioner must file a "complete application" with Housing and Neighborhood Department Staff no later than seven days before a scheduled regular meeting. The Historic Preservation Commission meets the second Thursday of each month at 5:00 P.M. in the McCloskey Room. The petitioner or his designee must attend the scheduled meeting in order to answer any questions or supply supporting material. You will be notified of the Commission's decision and a Certificate of Appropriateness will be issued to you. Copies of the Certificate must accompany any building permit application subsequently filed for the work described. If you feel uncertain of the merits of your petition, you also have the right to attend a preliminary hearing, which will allow you to discuss the proposal with the Commission before the hearing during which action is taken. Action on a filing must occur within thirty days of the filing date, unless a preliminary hearing is requested.

**Golden Hands Construction**  
334 S. Jackson Street  
Bloomington, IN 47403

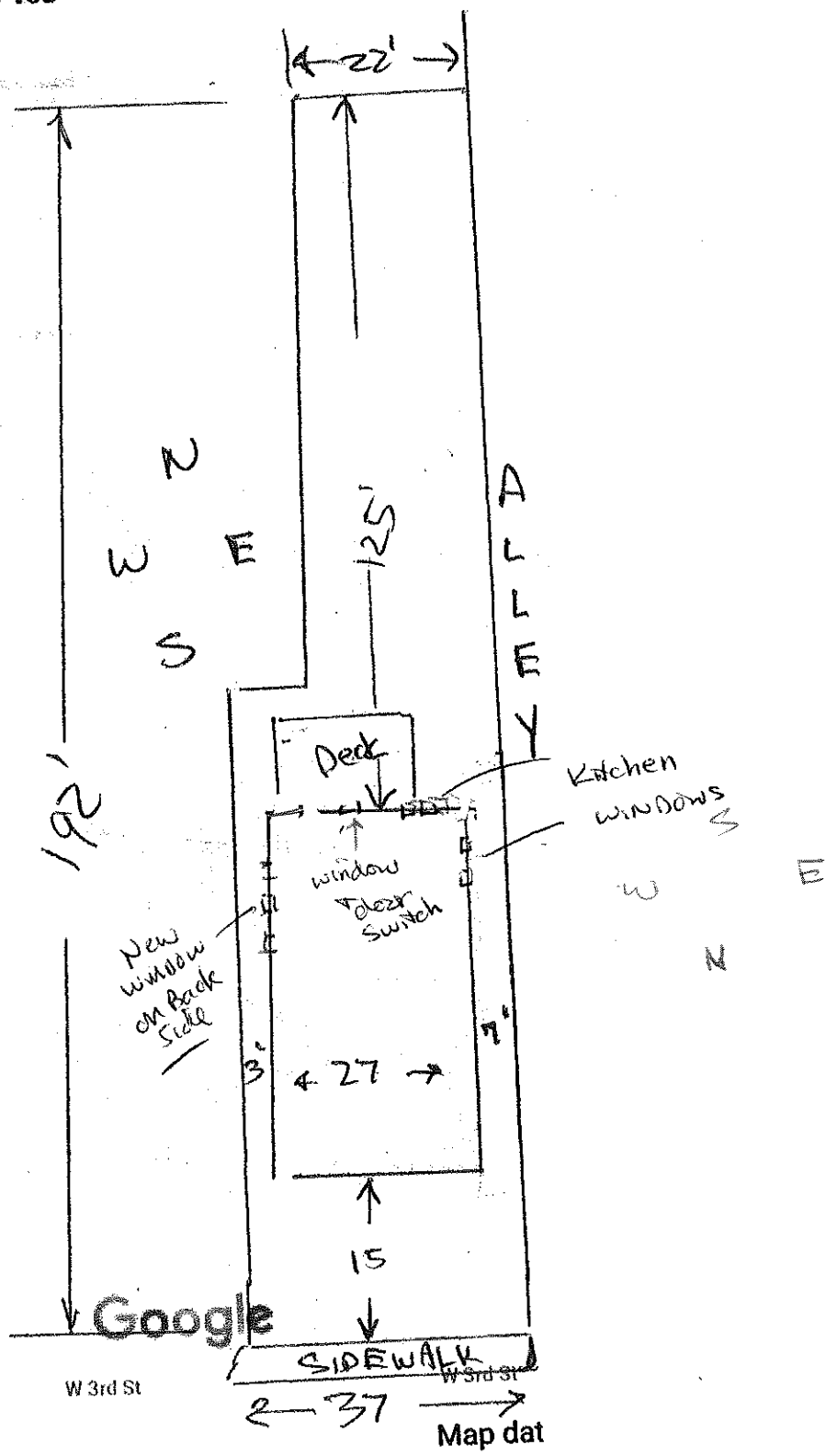

3rd St

702

W 3rd

W 3rd St

← 37 →  
Map dat

Third STREET

Please respond to the following questions and attach additional pages for photographs, drawings, surveys as requested.

A "Complete Application" consists of the following:

1. A legal description of the lot. 720 W 3rd

2. A description of the nature of the proposed modifications or new construction:

Interior remodeling to back of house will  
result in window & door changes.

Smaller windows for bath and kitchen areas.

3. A description of the materials used.

Marvin "Integrity" double hung windows

7 New Windows. Move door on back deck  
to the east.

4. Attach a drawing or provide a picture of the proposed modifications. You may use manufacturer's brochures if appropriate.

5. Include a scaled drawing, survey or geographic information system map showing the footprint of the existing structure and adjacent thoroughfares, Geographic Information System maps may be provided by staff if requested. Show this document to Planning Department Staff in order to ascertain whether variances or zoning actions are required.

6. Affix at least three photographs showing the existing full facade at each street frontage and the area of modification. If this petition is a proposal for construction of an entirely new structure or accessory building, include photographs of adjacent properties taken from the street exposure.

\*\*\*\*\*

If this application is part of a further submittal to the Board of Zoning Appeals for a Conditional Use or development standard variance, please describe the use proposed and modification to the property which will result.



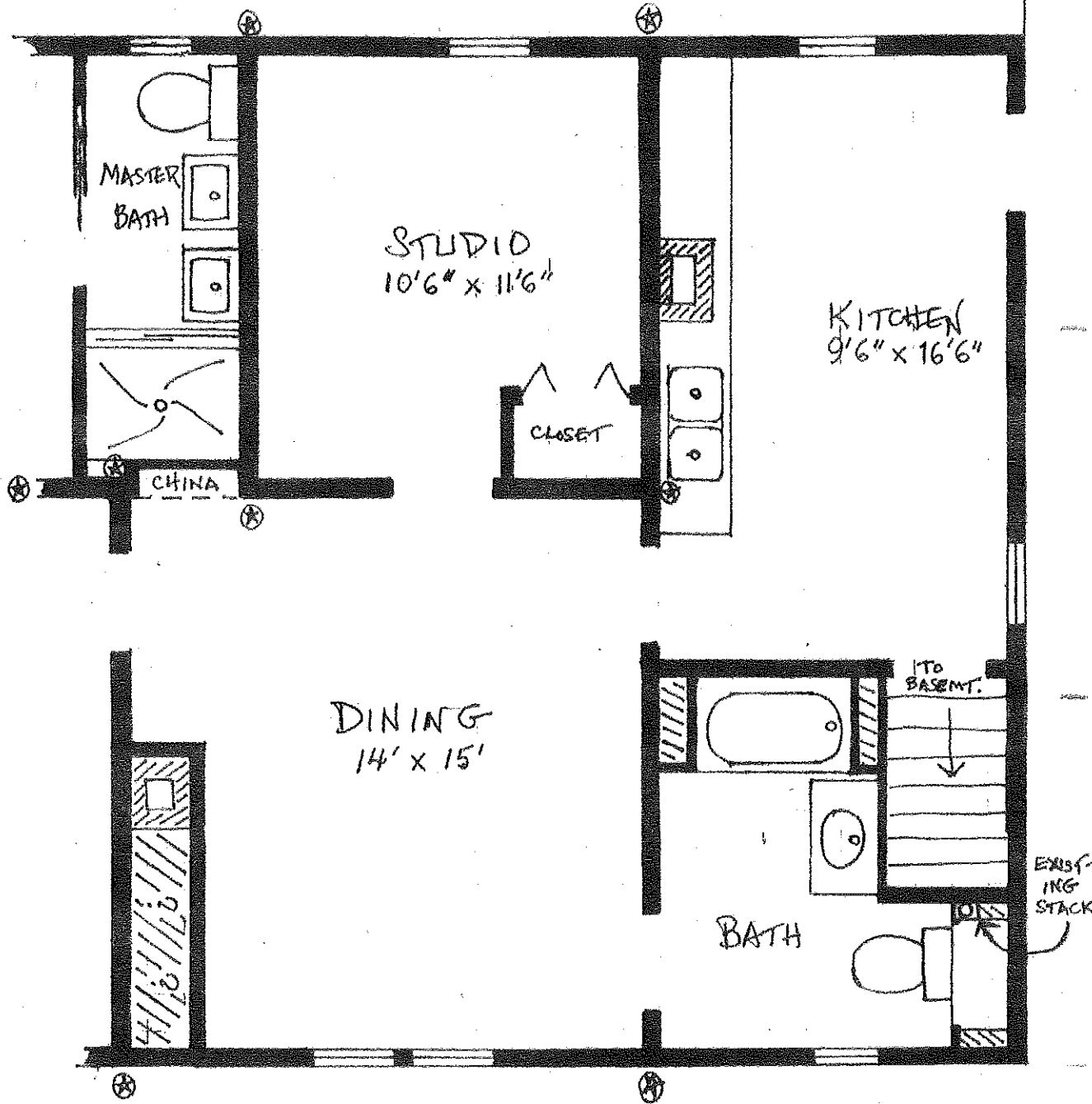

720 W. 3<sup>RD</sup> ST. - FALL 2016  
 (EXISTING LAYOUT)

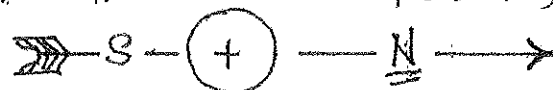

[1 SQUARE = 1 FOOT]  
 (Stars w/in circles indicate structural walls.)

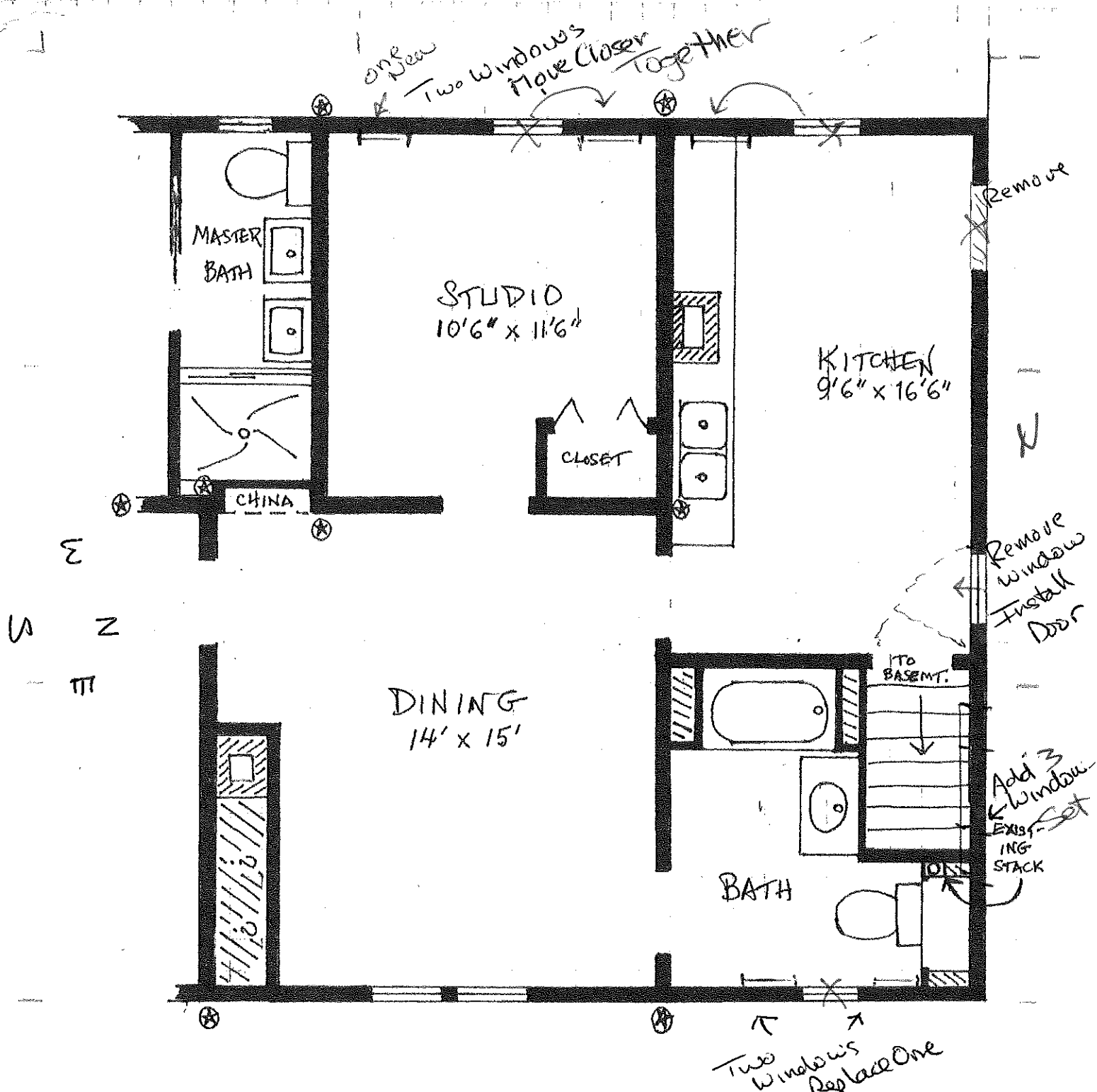

720 W. 3<sup>RD</sup> ST. - FALL 2016  
 (EXISTING LAYOUT)



[1 SQUARE = 1 FOOT]  
 (Stars w/in circles indicate structural walls.)

Before

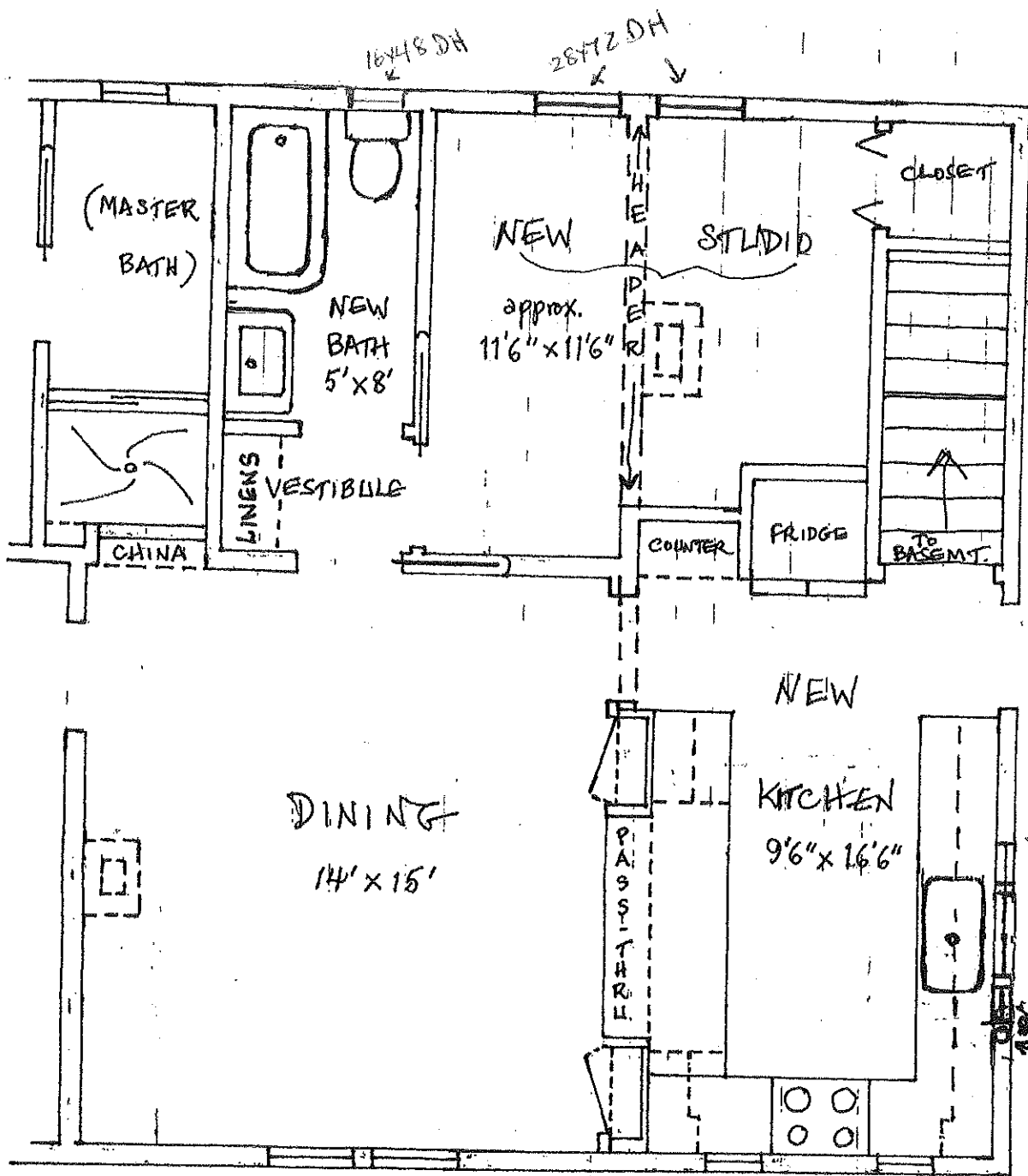

OPTION 1A: JULY-AUG. 2018.

720 W. 3RD ST.

[1 SQUARE = 1 FOOT]

RICHARD LEWIS & DON HARP

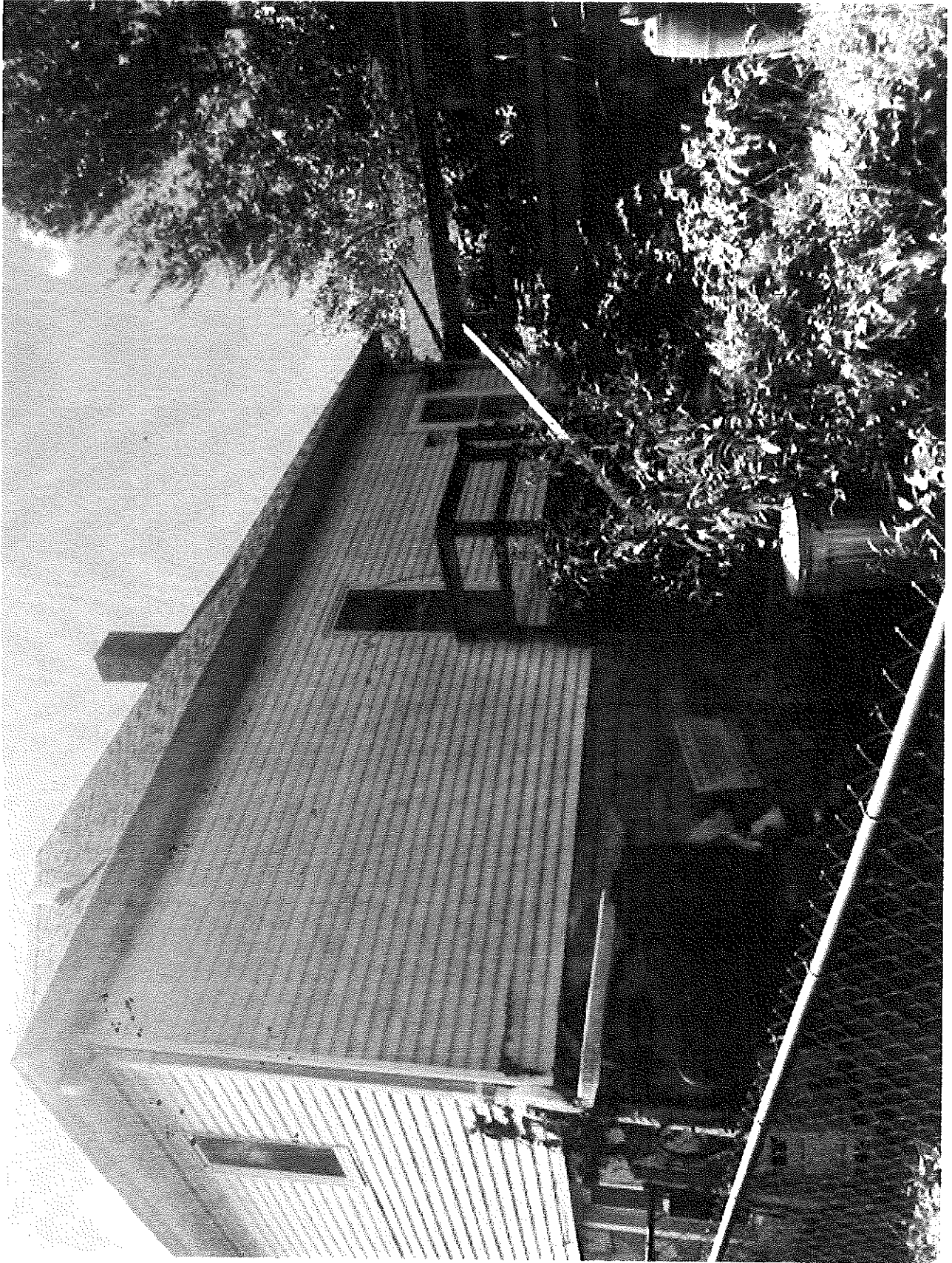

before



After



Before (w)



After (w)

**LINE ITEM QUOTES**

The following is a schedule of the windows and doors for this project. For additional unit details, please see Line Item Quotes. Additional charges, tax or Terms and Conditions may apply. Detail pricing is per unit.

Line #2	Mark Unit: 28 X 60	Net Price:	567.68
Qty: 2		Ext. Net Price:	1,135.36
		USD	



As Viewed From The Exterior  
 CN 2432

- Stone White Clad Exterior
- Primed Pine Interior .....24.32
- Clad Ultimate Double Hung - Next Generation 2.0 .....543.36
- CN 2432
- Rough Opening 30 1/4" X 72"
- Top Sash
- Stone White Clad Sash Exterior
- Primed Pine Sash Interior
- IG - 1 Lite
- Low E2 w/Argon
- Stainless Perimeter Bar
- Ogee Interior Glazing Profile
- Bottom Sash
- Stone White Clad Sash Exterior
- Primed Pine Sash Interior
- IG - 1 Lite
- Low E2 w/Argon
- Stainless Perimeter Bar
- Ogee Interior Glazing Profile
- White Interior Weather Strip Package
- White Exterior Weather Strip Package
- Satin Taupe Sash Lock
- Satin Taupe Top Sash Strike Plate Assembly Color
- Aluminum Screen
- Stone White Surround
- Charcoal Fiberglass Mesh
- \*\*\*Screen/Combo Ship Loose
- 4 9/16" Jamb
- Nailing Fin

*20x48  
 for Bath  
 (west wall)*

Line #3	Mark Unit: 15 X 36 LH	Net Price:	327.04
Qty: 1		Ext. Net Price:	327.04
		USD	

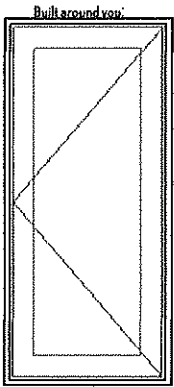

As Viewed From The Exterior  
 CN 1636

- Stone White Clad Exterior
- Primed Pine Interior .....24.32
- Clad Ultimate Casement - Left Hand .....302.72
- CN 1636
- Rough Opening 17" X 35 5/8"
- Frame Size 16" X 35 1/8"
- Stone White Clad Sash Exterior
- Primed Pine Sash Interior
- IG - 3/4" - 1 Lite
- Low E2 w/Argon
- Stainless Perimeter Bar
- Ogee Interior Glazing Profile
- Standard Bottom Rail
- White Weather Strip
- Satin Taupe Folding Handle
- Satin Taupe Multi - Point Lock
- Aluminum Screen
- Satin Taupe Surround
- Charcoal Fiberglass Mesh
- 4 9/16" Jamb
- Nailing Fin
- \*\*\*Note: Rotating wash mode hardware not available on UCA, URCA, UPCA, and URPCA units with frame width less than 20".

Line #4	Mark Unit: 15 X 36 RH	Net Price:	327.04
Qty: 1		Ext. Net Price:	327.04
		USD	



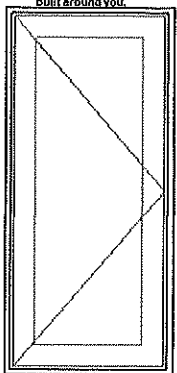

As Viewed From The Exterior  
 CN 1636

Stone White Clad Exterior  
 Primed Pine Interior ..... 24.32  
 Clad Ultimate Casement - Right Hand ..... 302.72  
 CN 1636  
 Rough Opening 17" X 35 5/8"  
 Frame Size 16" X 35 1/8"  
 Stone White Clad Sash Exterior  
 Primed Pine Sash Interior  
 IG - 3/4" - 1 Lite  
 Low E2 w/Argon  
 Stainless Perimeter Bar  
 Ogee Interior Glazing Profile  
 Standard Bottom Rail  
 White Weather Strip  
 Satin Taupe Folding Handle  
 Satin Taupe Multi - Point Lock  
 Aluminum Screen  
 Satin Taupe Surround  
 Charcoal Fiberglass Mesh  
 4 9/16" Jambs  
 Nailing Fin  
 \*\*\*Note: Rotating wash mode hardware not available on UCA, URCA, UPCA, and URPCA units with frame width less than 20".

Line #5	Mark Unit: 3W FIXED WITH FLANKERS	Net Price:	976.64
Qty: 1		Ext. Net Price:	976.64
		USD	

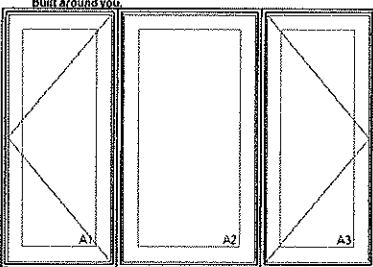

Stone White Clad Exterior  
 Primed Pine Interior ..... 72.96  
 3W1H - Rectangle Assembly  
 Assembly Rough Opening  
 53" X 35 5/8"  
 Unit: A1 ..... 302.72  
 Clad Ultimate Casement - Left Hand  
 CN 1636  
 Rough Opening 17" X 35 5/8"  
 Frame Size 16" X 35 1/8"  
 Stone White Clad Sash Exterior  
 Primed Pine Sash Interior  
 IG - 3/4" - 1 Lite  
 Low E2 w/Argon  
 Stainless Perimeter Bar  
 Ogee Interior Glazing Profile  
 Standard Bottom Rail  
 White Weather Strip  
 Satin Taupe Folding Handle  
 Satin Taupe Multi - Point Lock  
 Aluminum Screen  
 Satin Taupe Surround  
 Charcoal Fiberglass Mesh  
 Unit: A2 ..... 253.44  
 Clad Ultimate Casement - Stationary  
 CN 2036  
 Rough Opening 21" X 35 5/8"  
 Frame Size 20" X 35 1/8"  
 Stone White Clad Sash Exterior  
 Primed Pine Sash Interior  
 IG - 3/4" - 1 Lite  
 Low E2 w/Argon  
 Stainless Perimeter Bar  
 Ogee Interior Glazing Profile  
 Standard Bottom Rail  
 White Weather Strip  
 Solid Wood Covers  
 Unit: A3 ..... 302.72  
 Clad Ultimate Casement - Right Hand  
 CN 1636  
 Rough Opening 17" X 35 5/8"  
 Frame Size 16" X 35 1/8"

SUMMARY

COA 18-67

402 S. Rogers – Greater Prospect Hill  
Petitioner: Chris Sturbaum (Golden Hands Construction)

Contributing

105-055-54228

C. 1910



*Background:* Severely altered pyramid roof cottage in good condition.

*Request:* Replace existing vinyl windows with Marvin “Integrity” windows. Build screen porch with traditional rail and spindles on southwest corner of house. Restore the west exterior wall with wood and replacement of damaged siding.

*Guidelines:*

***Secretary of the Interior’s Standards for Rehabilitation:***

Standard 2: The historic character of a property will be retained and preserved. The removal of distinctive materials or alteration of features, spaces and spatial relationships that characterize a property will be avoided.

Standard 9: New additions, exterior alterations or related new construction will not destroy historic materials, features and spatial relationships that characterize the property. The new work will be differentiated from the old and will be compatible with the historic materials, features, size, scale and proportion, and massing to protect the integrity of the property and its environment.

Standard 10: New additions and adjacent or related new construction will be undertaken in such a manner that, if removed in the future, the essential form and integrity of the historic property and its environment would be unimpaired.

### ***Local Historic District Design Guidelines***

#### Fenestration

1. Creative expression with fenestration is not precluded provided the result does not conflict with or draw attention from surrounding historic buildings.
2. Windows and doors should be arranged on the building so as not to conflict with the basic fenestration pattern in the area.
4. Window openings should reflect the basic proportionality and directionality of those typically found on surrounding historic buildings.

#### Additions

2. Excessive impact to the public way façade should be discouraged.

#### New Construction

1. New construction must use the existing historic building as its most important, perhaps only, context.

#### Materials

1. Building materials should be visually compatible with surrounding historic buildings.

#### Outline

2. The outline of new construction should reflect the directional orientations characteristic of the existing building in its context.

*Recommendations:* Staff recommends approval of COA 18-67. There are no issues with siding repair. Window replacement of newer vinyl windows will be a historic improvement. Screen porch has the potential for the most impact, but is positioned and massed appropriately and only partially visible from the main public way. Flexibility with removal of siding, etc. to allow such an addition is within district guidelines. Petitioner should, however, confirm for the record exact materials and anticipated color of the porch.

APPLICATION FORM  
CERTIFICATE OF APPROPRIATENESS

Case Number: 18-67

Date Filed: 2/11/18

Scheduled for Hearing: Sep 27

\*\*\*\*\*

Address of Historic Property: 402 S Rogers

Petitioner's Name: Chris Sturbawn / Golden Hands Const

Petitioner's Address: 334 S Jackson

Phone Number/e-mail: 812 336-9171 / 812-3400724 / goldenhandsinc @comcast.net

Owner's Name: Laurel Cornell

Owner's Address: 402 S Rogers

Phone Number/e-mail: 812-219-2051

Instructions to Petitioners

The petitioner must attend a preliminary meeting with staff of the Department of Housing and Neighborhood Development during which the petitioner will be advised as to the appropriateness of the request and the process of obtaining a Certificate of Appropriateness. The petitioner must file a "complete application" with Housing and Neighborhood Department Staff no later than seven days before a scheduled regular meeting. The Historic Preservation Commission meets the second Thursday of each month at 5:00 P.M. in the McCloskey Room. The petitioner or his designee must attend the scheduled meeting in order to answer any questions or supply supporting material. You will be notified of the Commission's decision and a Certificate of Appropriateness will be issued to you. Copies of the Certificate must accompany any building permit application subsequently filed for the work described. If you feel uncertain of the merits of your petition, you also have the right to attend a preliminary hearing, which will allow you to discuss the proposal with the Commission before the hearing during which action is taken. Action on a filing must occur within thirty days of the filing date, unless a preliminary hearing is requested.

Please respond to the following questions and attach additional pages for photographs, drawings, surveys as requested.

A "Complete Application" consists of the following:

1. A legal description of the lot. 402 S Rogers
2. A description of the nature of the proposed modifications or new construction:
  - \* Replace existing vinyl windows with Marvin "Integrity"
  - \* Build Screen Porch on S W corner of house
  - \* Restore west Exterior Wall
3. A description of the materials used.
  - Treated wood
  - Traditional Rail + Spindles
  - Wood Siding to Replace Damaged Siding on West Side
4. Attach a drawing or provide a picture of the proposed modifications. You may use manufacturer's brochures if appropriate.
5. Include a scaled drawing, survey or geographic information system map showing the footprint of the existing structure and adjacent thoroughfares, Geographic Information System maps may be provided by staff if requested. Show this document to Planning Department Staff in order to ascertain whether variances or zoning actions are required.
6. Affix at least three photographs showing the existing full facade at each street frontage and the area of modification. If this petition is a proposal for construction of an entirely new structure or accessory building, include photographs of adjacent properties taken from the street exposure.

\*\*\*\*\*

If this application is part of a further submittal to the Board of Zoning Appeals for a Conditional Use or development standard variance, please describe the use proposed and modification to the property which will result.

**GOLDEN HANDS CONSTRUCTION**  
**334 SOUTH JACKSON**  
**BLOOMINGTON IN 47403**

**CHRIS STURBAUM**  
**PHONE/FAX: 812-336-9171**

**402 S. ROGERS STREET**

N E  
W S

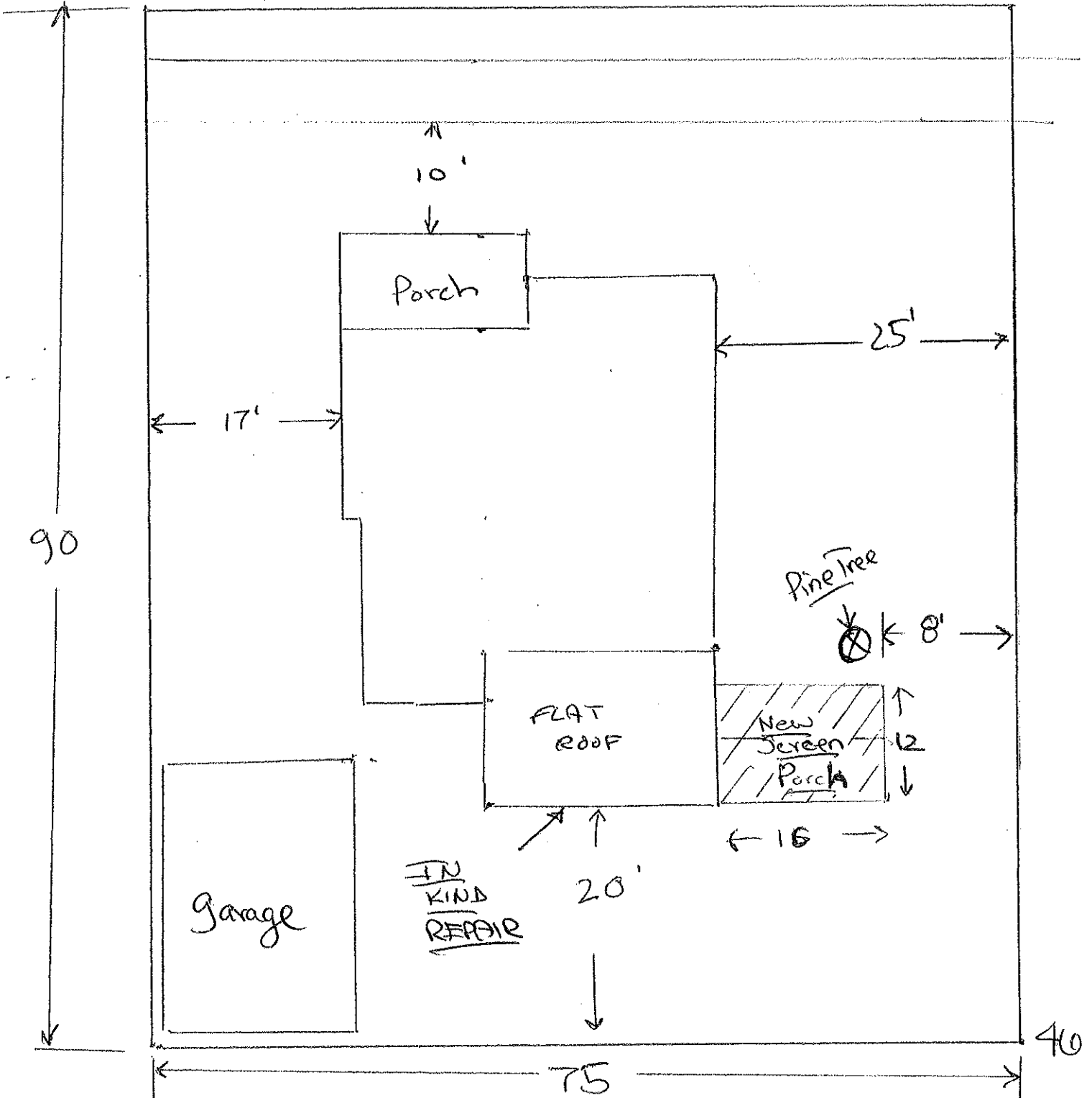











Replace Windows / Repair JutKind

View from  
S. 1st St  
to  
S. 2nd St  
to  
S. 3rd St  
to  
S. 4th St





View from Streets of Screen porch

## SUMMARY

COA 18-68

201 E. State Road 45/46 Bypass – Matlock Heights  
Petitioner: Derk Brewer

Contributing (not present in resurvey if adopted)

C. 1955



*Background:* Massed Plan Ranch House.

*Request:* Attach lumber and vinyl garage to rear of existing home.

*Guidelines:*

***Secretary of the Interior's Standards for Rehabilitation:***

Standard 2: The historic character of a property will be retained and preserved. The removal of distinctive materials or alteration of features, spaces and spatial relationships that characterize a property will be avoided.

Standard 9: New additions, exterior alterations or related new construction will not destroy historic materials, features and spatial relationships that characterize the property. The new work will be differentiated from the old and will be compatible with the historic materials, features, size, scale and proportion, and massing to protect the integrity of the property and its environment.

Standard 10: New additions and adjacent or related new construction will be undertaken in such a manner that, if removed in the future, the essential form and integrity of the historic property and its environment would be unimpaired.

## ***Local Historic District Design Guidelines***

### **Outbuildings**

\*If the new structure is a garage, every effort should be made to attach it to an existing house . . . The material should be compatible, but not required to match the primary structure.

\*New structures should be proportionately smaller, both in height and size of footprint, than the primary building on the lot.

*Recommendations:* Staff recommends approval of COA 18-68. Unfortunately, recent substantial work to the house has made it hardly recognizable as a mid-century ranch. However, it appears this work was done prior to historic designation; status appears to have been a conservation district. The addition of the garage is not visible from the primary public way, and instead only visible from the Walnut commercial corridor. The aesthetics of the addition blend well into the current structure and it does not appear the garage will add further distraction to the district.

9/18/18

APPLICATION FORM  
CERTIFICATE OF APPROPRIATENESS

Case Number: 18-~~000~~68

Date Filed: 9/18/18

Scheduled for Hearing: Sept. 27

\*\*\*\*\*

Address of Historic Property: 201 EST RD 45/46 BYPASS

Petitioner's Name: DERY BREWER

Petitioner's Address: SAME

Phone Number/e-mail: dermat@aol.com 812-360-4195

Owner's Name: SAME

Owner's Address: SAME

Phone Number/e-mail: SAME

Instructions to Petitioners

The petitioner must attend a preliminary meeting with staff of the Department of Housing and Neighborhood Development during which the petitioner will be advised as to the appropriateness of the request and the process of obtaining a Certificate of Appropriateness. The petitioner must file a "complete application" with Housing and Neighborhood Department Staff no later than seven days before a scheduled regular meeting. The Historic Preservation Commission meets the second Thursday of each month at 5:00 P.M. in the McCloskey Room. The petitioner or his designee must attend the scheduled meeting in order to answer any questions or supply supporting material. You will be notified of the Commission's decision and a Certificate of Appropriateness will be issued to you. Copies of the Certificate must accompany any building permit application subsequently filed for the work described. If you feel uncertain of the merits of your petition, you also have the right to attend a preliminary hearing, which will allow you to discuss the proposal with the Commission before the hearing during which action is taken. Action on a filing must occur within thirty days of the filing date, unless a preliminary hearing is requested.

55

Please respond to the following questions and attach additional pages for photographs, drawings, surveys as requested.

A "Complete Application" consists of the following:

1. A legal description of the lot. LOT #1 BREWER MATLOCK SUBDIVISION 013-23350-00

2. A description of the nature of the proposed modifications or new construction:

ATTACHED GARAGE TO REAR OF EXISTING HOME

3. A description of the materials used.

LUMBER AND VINYL

4. Attach a drawing or provide a picture of the proposed modifications. You may use manufacturer's brochures if appropriate.

5. Include a scaled drawing, survey or geographic information system map showing the footprint of the existing structure and adjacent thoroughfares, Geographic Information System maps may be provided by staff if requested. Show this document to Planning Department Staff in order to ascertain whether variances or zoning actions are required.

6. Affix at least three photographs showing the existing full facade at each street frontage and the area of modification. If this petition is a proposal for construction of an entirely new structure or accessory building, include photographs of adjacent properties taken from the street exposure.

\*\*\*\*\*

If this application is part of a further submittal to the Board of Zoning Appeals for a Conditional Use or development standard variance, please describe the use proposed and modification to the property which will result.



SUMMARY

COA 18-50 (Amended)

210 E. Gilbert Drive – Matlock Heights  
Petitioner: Russ Herndon (Loren Wood Builders)

2001 SHAARD, not include in 2014

C. 1955



*Background:* Zoned RS-Residential Single Family.

*Request:* Change to a freestanding detached pool structure in rear.

*Guidelines:*

***Secretary of the Interior's Standards for Rehabilitation:***

Standard 2: The historic character of a property will be retained and preserved. The removal of distinctive materials or alteration of features, spaces and spatial relationships that characterize a property will be avoided.

Standard 9: New additions, exterior alterations or related new construction will not destroy historic materials, features and spatial relationships that characterize the property. The new work

will be differentiated from the old and will be compatible with the historic materials, features, size, scale and proportion, and massing to protect the integrity of the property and its environment.

Standard 10: New additions and adjacent or related new construction will be undertaken in such a manner that, if removed in the future, the essential form and integrity of the historic property and its environment would be unimpaired.

### ***Local Historic District Design Guidelines***

#### **Context for New Construction – Developed Site**

\*New construction should use the existing historic building as the most important, perhaps only, context. It should not overwhelm in scale or proportion and should not exceed the height of the primary building.

#### **Materials**

\*Building materials, whether natural or man-made, should be visually compatible with surrounding contributing buildings.

\*No products imitating the “grain” of wood should be used.

\*Limestone/sandstone, brick, clapboard, wood, and cement board are appropriate materials.

*Recommendations:* Staff recommends approval of COA 18-50 (Amended). Primary reason is the minimal, if any visibility, of the amended structure in the rear of the home to the public right of way. Due to the curve of E. Gilbert Drive and lack of structure on the west side of the home, it is possible minor visibility will be present from one of the surrounding roadways. The structure, though large, is shorter than the prior submission and should not be visible over the top of the home. The detached nature of the structure prevents damage to the existing building and allows for potential future removal. Staff’s primary concern is that the structure seems very contemporary in relation to the home and if more visible may be distracting. The aluminum frame may be blended better with the use of bronze coloring as mentioned in the petition. Per guidelines, the base of the structure should not be imitation wood.

APPLICATION FORM  
CERTIFICATE OF APPROPRIATENESS

Case Number: 18-~~000~~50 (amendment)

Date Filed: Sept. 19, 2018

Scheduled for Hearing: Sept. 27, 2018

\*\*\*\*\*

Address of Historic Property: 210 E. GILBERT DRIVE

Petitioner's Name: RUSS HERNDON - FOR LOREN WOOD BUILDERS

Petitioner's Address: 4413 WATSON RD. NASHVILLE, TN 37248

Phone Number/e-mail: RUSS@RUSSHENDONDESIGN.COM 812-345-0045

Owner's Name: MICHAEL D. MAY, ANN ST. JOHN

Owner's Address: 210 E. GILBERT DR

Phone Number/e-mail: astjohn@stjohnjass.com

Instructions to Petitioners

The petitioner must attend a preliminary meeting with staff of the Department of Housing and Neighborhood Development during which the petitioner will be advised as to the appropriateness of the request and the process of obtaining a Certificate of Appropriateness. The petitioner must file a "complete application" with Housing and Neighborhood Department Staff no later than seven days before a scheduled regular meeting. The Historic Preservation Commission meets the second Thursday of each month at 5:00 P.M. in the McCloskey Room. The petitioner or his designee must attend the scheduled meeting in order to answer any questions or supply supporting material. You will be notified of the Commission's decision and a Certificate of Appropriateness will be issued to you. Copies of the Certificate must accompany any building permit application subsequently filed for the work described. If you feel uncertain of the merits of your petition, you also have the right to attend a preliminary hearing, which will allow you to discuss the proposal with the Commission before the hearing during which action is taken. Action on a filing must occur within thirty days of the filing date, unless a preliminary hearing is requested.

Please respond to the following questions and attach additional pages for photographs, drawings, surveys as requested.

A "Complete Application" consists of the following:

1. A legal description of the lot. SEE ATTACHED
2. A description of the nature of the proposed modifications or new construction:  
CLIENT WISHES TO CONSTRUCT A FREE STANDING (DETACHED) STRUCTURE APPROX. 790 sq - COMMERCIAL POOL ENCLOSURE. THIS ENCLOSURE WILL HOUSE AN "ENDLESS POOL", A HOT TUB, AND A FREE STANDING SHOWER. DEPENDING ON EXCAVATING LIMITATIONS, WE VISUALIZE (SEE DWGS) A PERIMETER KNEE-WALL OF APPROXIMATE 3' 4" HEIGHT - PARTIALLY RECESSED IN THE GROUND.

3. A description of the materials used.  
POURED WALLS & SLAB - CONCRETE. FLOOR FINISH EXPOSED AGGREGATE WITH EMBEDDED "RADIANT" HEATING LOOPS. THE STRUCTURAL FRAME IS EXTENDED ALUMINUM (PROBABLY BRONZE IN COLOR) TO TIE WITH THE PER GRAVEL COLOR OF THE EXPOSED AGGREGATE FLOOR FINISH.

4. Attach a drawing or provide a picture of the proposed modifications. You may use manufacturer's brochures if appropriate.

5. Include a scaled drawing, survey or geographic information system map showing the footprint of the existing structure and adjacent thoroughfares, Geographic Information System maps may be provided by staff if requested. Show this document to Planning Department Staff in order to ascertain whether variances or zoning actions are required. IN PHONE DISCUSSION THIS MEETS SETBACKS & DOES NOT EXCEED 840 sq MAX. FOR DETACHED STRUCTURE.

6. Affix at least three photographs showing the existing full facade at each street frontage and the area of modification. If this petition is a proposal for construction of an entirely new structure or accessory building, include photographs of adjacent properties taken from the street exposure.

EXISTING FROM PREVIOUS SUBMISSION; ASSUME THESE ARE ADEQUATE?  
\*\*\*\*\*  
PLS. ADVISE IF NOT.

If this application is part of a further submittal to the Board of Zoning Appeals for a Conditional Use or development standard variance, please describe the use proposed and modification to the property which will result.

ST. JOHN POOL ENCLOSURE 09.18.18

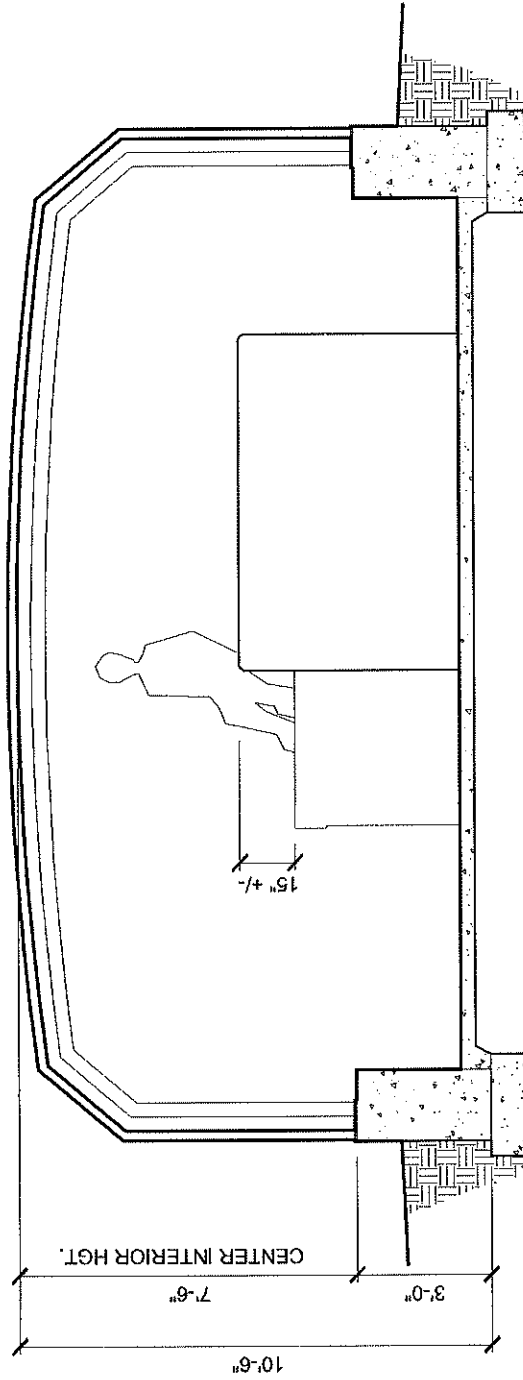

SECTION  
SCALE: 1/4" = 1'-0"

**HERNDON DESIGN**  
BLOOMINGTON, INDIANA  
phone 812-345-0045  
russ@russherndon.com  
www.russherndon.com

61

ST. JOHN POOL ENCLOSURE 09.18.18  
210 E. GILBERT DRIVE



**SITE PLAN**  
SCALE 1" = 20'-0"

ST. JOHN POOL ENCLOSURE 09.18.18

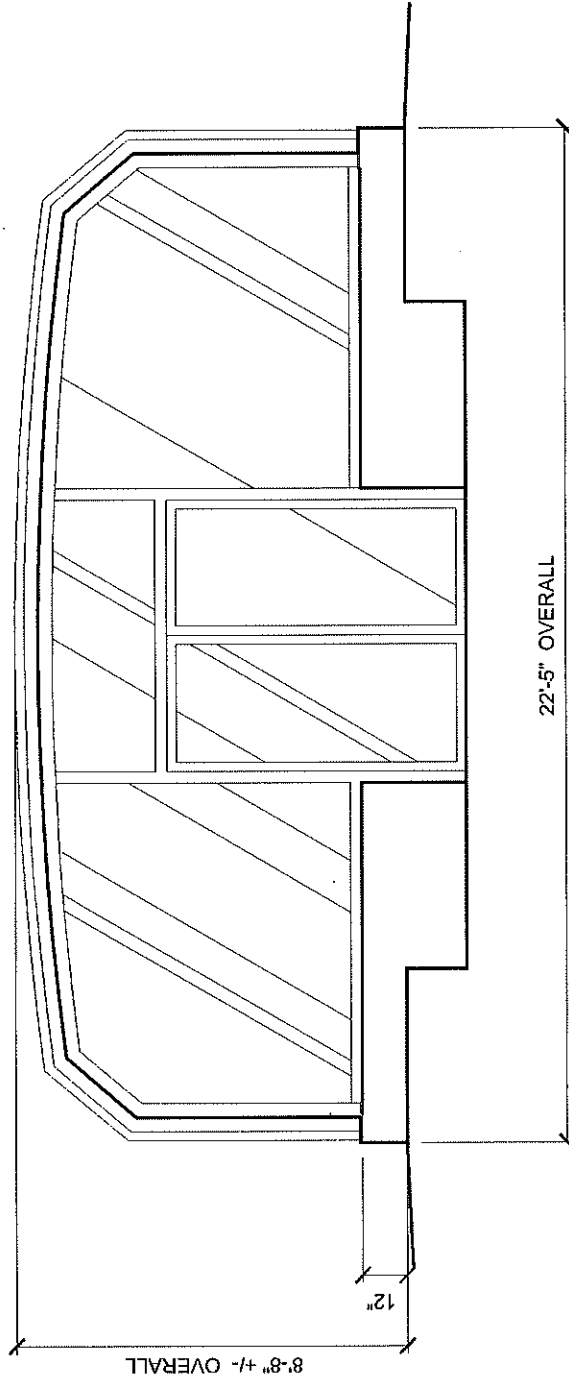

ELEVATION  
SCALE: 1/4" = 1'-0"

**HERNDON DESIGN**  
BLOOMINGTON, INDIANA  
phone 812.945.0045  
russ@russherndon.com  
www.russherndon.com

63

ST. JOHN POOL ENCLOSURE 09.18.18  
210 E. GILBERT DRIVE

42" FREE-STANDING SHOWER

SILL COCK

NOTES:

FLOOR DRAINS T.B.D.

RADIANT HYDRONIC HEATING IN FLOOR AND WALKWAY TO GARAGE

NEW DOOR WITHIN EXISTING GARAGE WINDOW R.O.

PRELIM. PLAN  
SCALE: 3/16" = 1'-0"

← TO GARAGE

DRY LAID LIMESTONE TO MATCH EXISTING

**HERNDON DESIGN**  
BLOOMINGTON, INDIANA  
phone 812.345.0045  
russ@russherndondesign.com  
www.russherndondesign.com

64

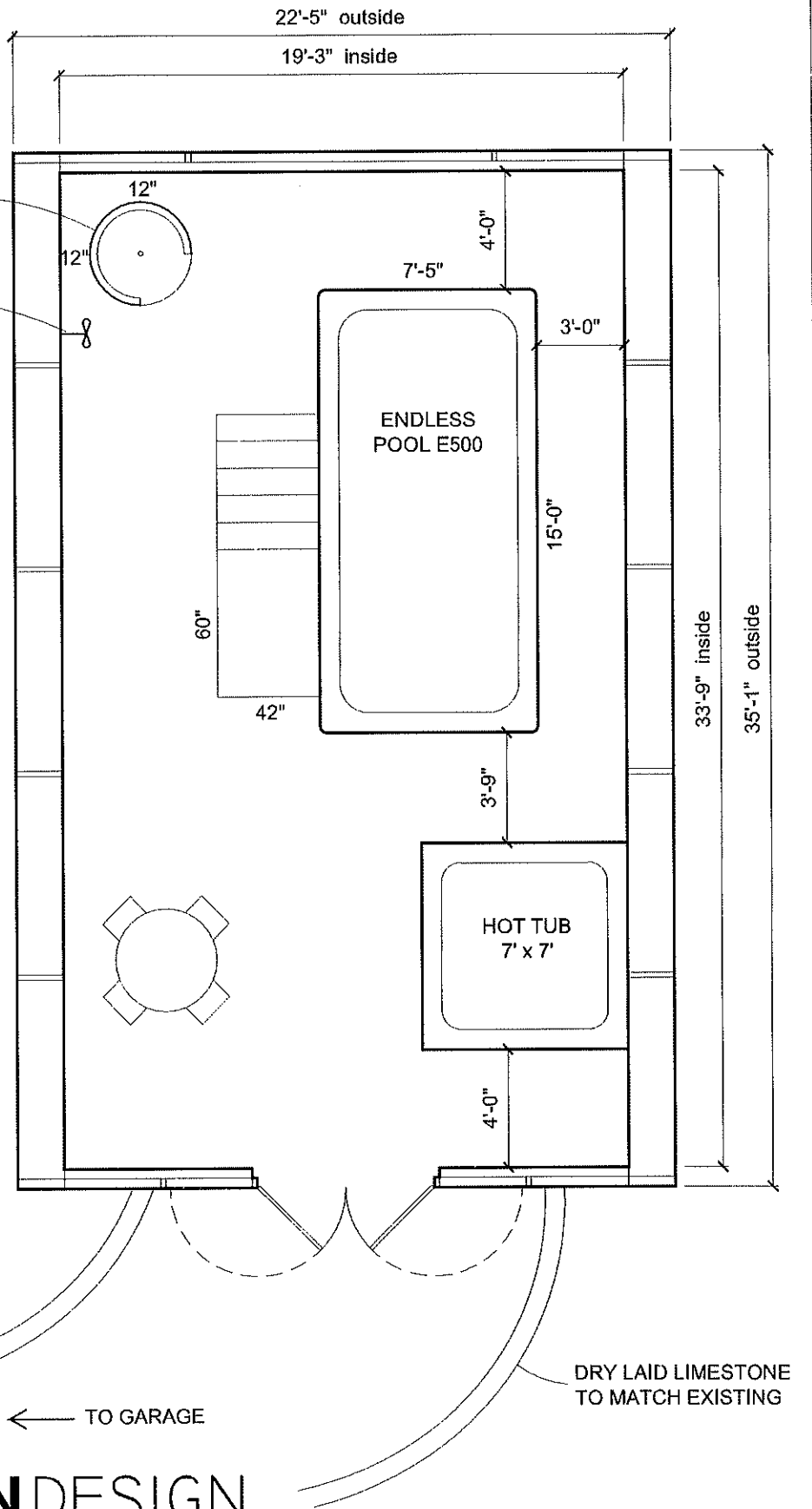



9/19/2018

pool-enclosure-oceanic-high-5.jpg



605

# JETSETTER NXT (Model JTN)

## Dimensions

**NOTE: All dimensions are approximate; measure your spa before making critical design or pathway decisions.**

(Front view)

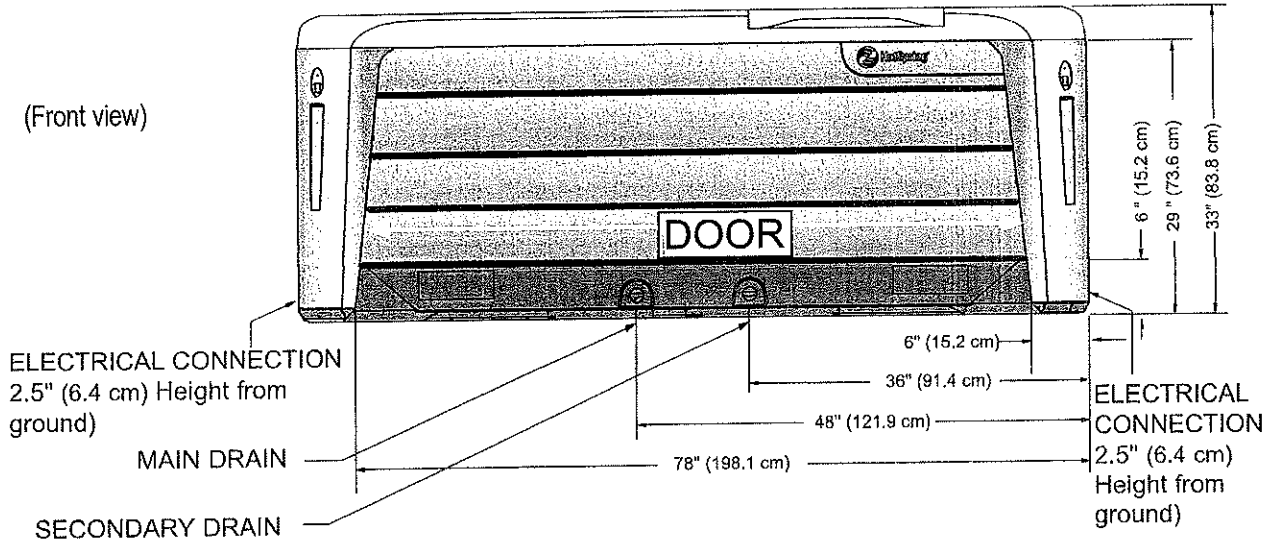

(Bottom view)

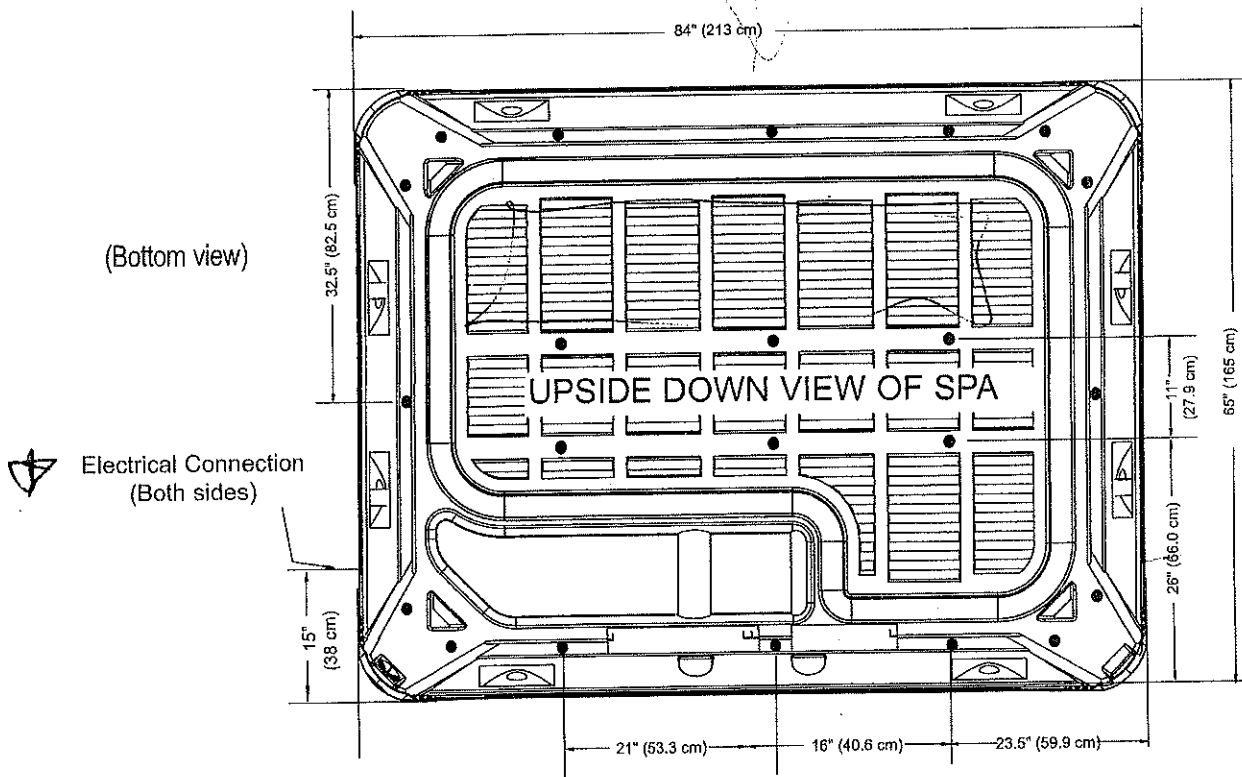

↙ DOOR SIDE ↘

- 22 leveling points (place shims at illustrated locations).

66

# Endless Pools® Fitness Systems | E500

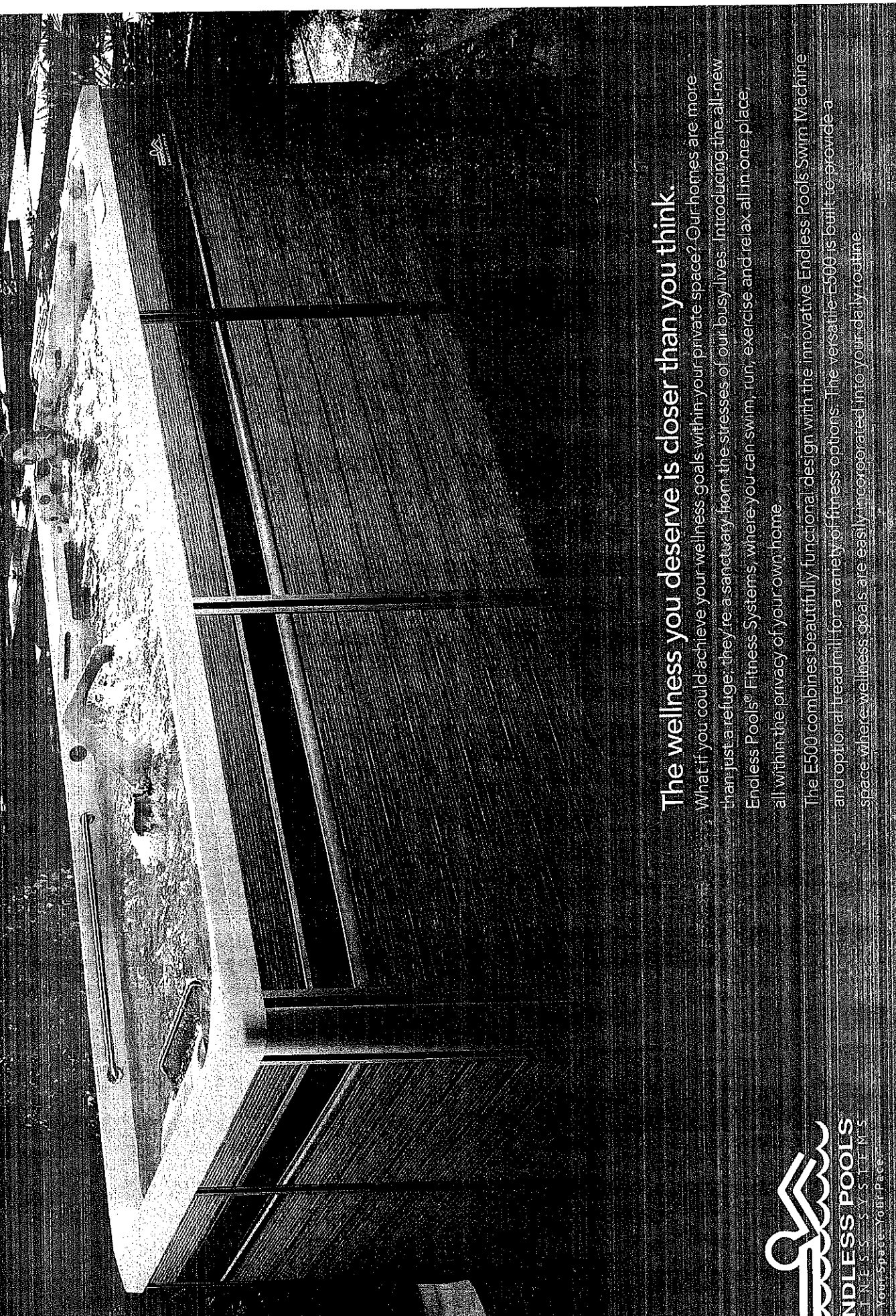

## The wellness you deserve is closer than you think.

What if you could achieve your wellness goals within your private space? Our homes are more than just a refuge; they're a sanctuary from the stresses of our busy lives. Introducing the all-new Endless Pools® Fitness Systems where you can swim, run, exercise and relax all in one place, all within the privacy of your own home.

The E500 combines beautifully functional design with the innovative Endless Pools Swim Machine and optional treadmill for a variety of fitness options. The versatile E500 is built to provide a space where wellness goals are easily incorporated into your daily routine.

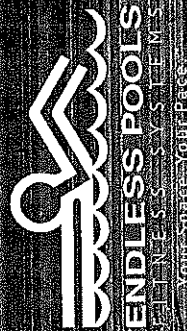

Your Space. Your Pace.



3

3

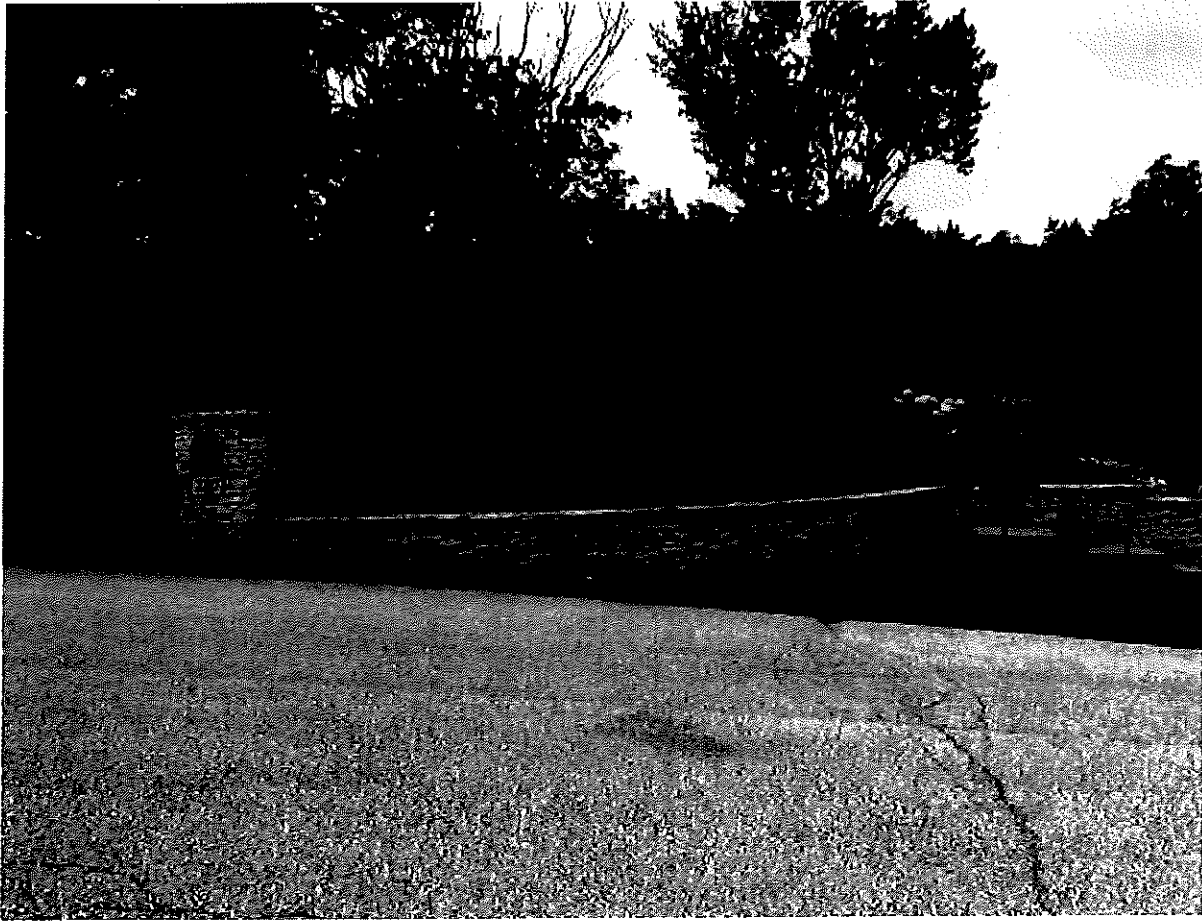



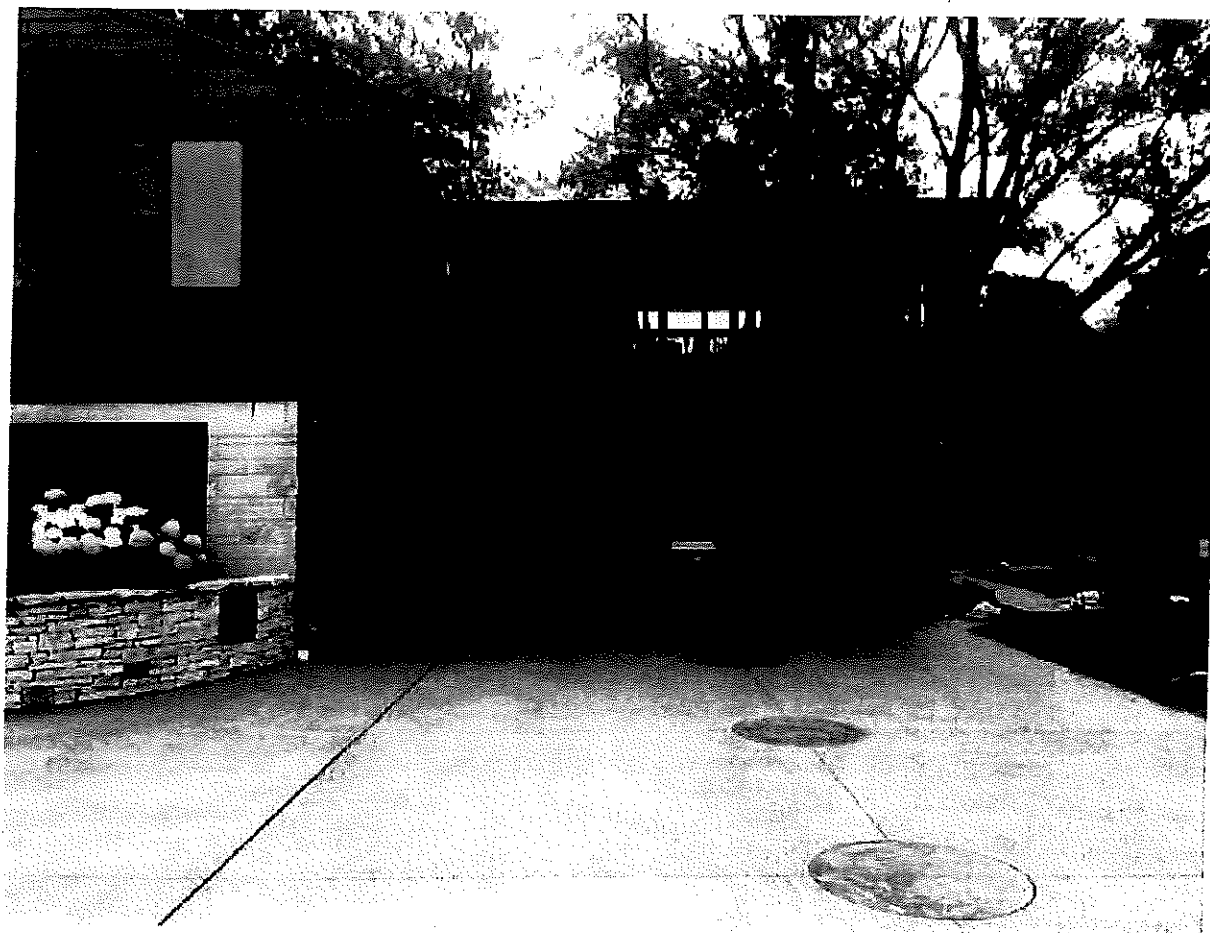





APPLICATION FORM  
CERTIFICATE OF APPROPRIATENESS

RECEIVED  
JUL 04 2018  
BY: RILE

Case Number: COA 18-50

Date Filed: July 4, 2018

Scheduled for Hearing: July 12, 2018

\*\*\*\*\*

Address of Historic Property: 210 E. GILBERT DRIVE

Petitioner's Name: RUSS HERNDON - FOR LAREN WOOD BUILDERS

Petitioner's Address: 4413 WATSON RD. NASHVILLE, TN 37248

Phone Number/e-mail: RUSS@RUSSHERNDONDESIGN.COM 612-345-0045

Owner's Name: MICHAEL D. MAY, ANNI ST. JOHN

Owner's Address: 210 E. GILBERT DR

Phone Number/e-mail: astjohn@stjohnjoss.com

Instructions to Petitioners

The petitioner must attend a preliminary meeting with staff of the Department of Housing and Neighborhood Development during which the petitioner will be advised as to the appropriateness of the request and the process of obtaining a Certificate of Appropriateness. The petitioner must file a "complete application" with Housing and Neighborhood Department Staff no later than seven days before a scheduled regular meeting. The Historic Preservation Commission meets the second Thursday of each month at 5:00 P.M. in the McCloskey Room. The petitioner or his designee must attend the scheduled meeting in order to answer any questions or supply supporting material. You will be notified of the Commission's decision and a Certificate of Appropriateness will be issued to you. Copies of the Certificate must accompany any building permit application subsequently filed for the work described. If you feel uncertain of the merits of your petition, you also have the right to attend a preliminary hearing, which will allow you to discuss the proposal with the Commission before the hearing during which action is taken. Action on a filing must occur within thirty days of the filing date, unless a preliminary hearing is requested.

Please respond to the following questions and attach additional pages for photographs, drawings, surveys as requested.

A "Complete Application" consists of the following:

1. A legal description of the lot. ATTACHED - ELECTRONIC (EMAIL)
2. A description of the nature of the proposed modifications or new construction:  
APPROX. 624 sq GABLE ROOF ADDITION ON THE SOUTH (REAR) OF EXIST. BLDG. (SEE PHOTOS) NOT VISIBLE FROM STREET (WINTER POSSIBLE EAST REAR VIEW THROUGH TREES). PURPOSE TO HOUSE A POOL/HOT TUB/SHOWER AREA - CONVERTED TO MASTER BEDROOM AND ALSO ACCESSIBLE FROM EXTERIOR ENTRANCE ADJACENT TO SCREEN PORCH & COVERED PORCH.
3. A description of the materials used. - THE HOME IS CLAD IN DEVEL. WOOD SIDING WITH A DARK BROWN FINISH. ORIGINALS PROPOSED TO CLIMB IN CLIMB HORIZONTAL TYPE SIDING LAP, TO MATCH WITH A SOLID LAKE STAIN, ANOTHER OPTION POSSIBLY SELECTED COULD BE CEMENT BOARDS T-111 TYPE SIDING, TO VISIBLY DEFINE THE POOL ADDITION "PHASE" IN THE HISTORY OF THE IMPROVEMENT OR CHANGES TO THE HOME.  
\* WITH OR WITHOUT VERTICAL GROOVES (WOOD EMBOS TEXTURE)
4. Attach a drawing or provide a picture of the proposed modifications. You may use manufacturer's brochures if appropriate. (EMAILS)
5. Include a scaled drawing, survey or geographic information system map showing the footprint of the existing structure and adjacent thoroughfares. Geographic Information System maps may be provided by staff if requested. Show this document to Planning Department Staff in order to ascertain whether variances or zoning actions are required.
6. Affix at least three photographs showing the existing full facade at each street frontage and the area of modification. If this petition is a proposal for construction of an entirely new structure or accessory building, include photographs of adjacent properties taken from the street exposure.  
ATTACHED VIA EMAIL

\*\*\*\*\*

If this application is part of a further submittal to the Board of Zoning Appeals for a Conditional Use or development standard variance, please describe the use proposed and modification to the property which will result.

POOL ROOM ADDITION

07.04.18

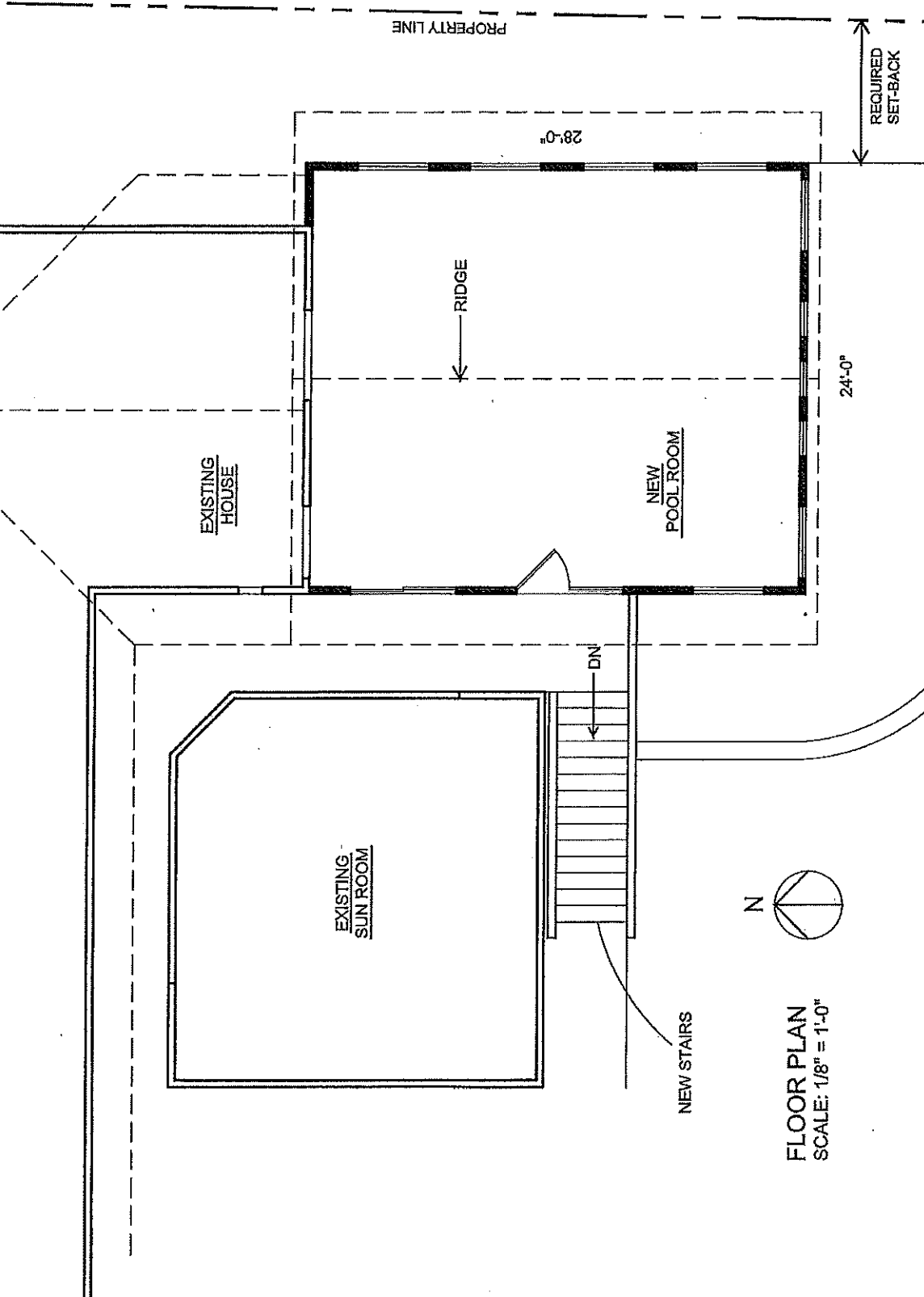

FLOOR PLAN  
SCALE: 1/8" = 1'-0"

Loren Wood Builders:  
customer: St. John  
210 E. Gilbert Dr. Bloomington, IN

74

POOL ROOM ADDITION

07.04.18

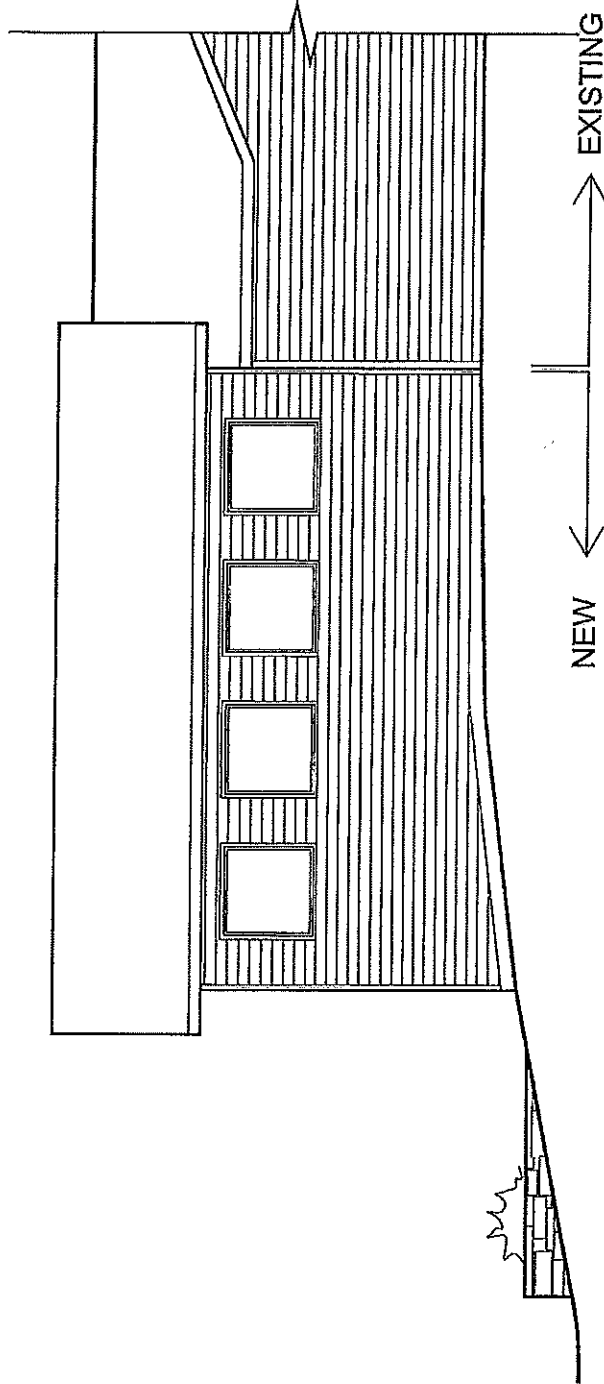

SIDE / EAST ELEVATION  
SCALE: 1/8" = 1'-0"

Loren Wood Builders:  
customer: St. John  
210 E .Gilbert Dr. Bloomington, IN

POOL ROOM ADDITION

07.04.18

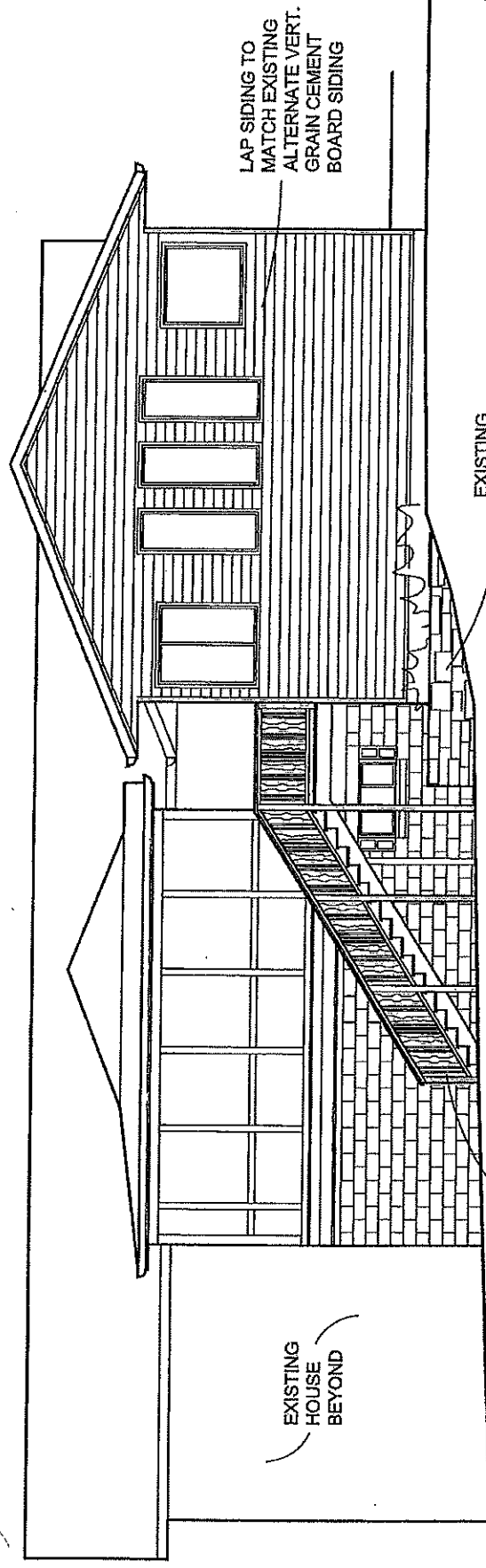

LAP SIDING TO  
MATCH EXISTING  
ALTERNATE VERT.  
GRAIN CEMENT  
BOARD SIDING

EXISTING  
STONE PLANTER

EXISTING ← → NEW

CRAFTSMAN STYLE  
HANDRAIL TO  
MATCH EXISTING

REAR / SOUTH ELEVATION  
SCALE: 1/8" = 1'-0"

Loren Wood Builders:  
customer: St. John  
210 E. Gilbert Dr. Bloomington, IN

SUMMARY

COA 18-69

515 W. 3<sup>rd</sup> Street – Prospect Hill  
Petitioner: Charles and Patricia Russo

Notable

105-055-46013

C. 1906



*Background:* Excellent condition slightly altered Late Victorian. Historically known as the Mickey Burke House, built for a conductor on the Monon Railroad.

*Request:* New paint for home and garage. Proposal is Kendall Charcoal Gray, with Amherst Gray accent, and white trim or Connected Gray with white trim.

*Guidelines:*

***Secretary of the Interior's Standards for Rehabilitation:***

Standard 2: The historic character of a property will be retained and preserved.

Standard 5: Distinctive materials, features, finishes and construction techniques or examples of craftsmanship that characterize a property will be preserved.

Standard 6: Deteriorated historic features will be repaired rather than replaced. Where the severity of deterioration requires replacement of a distinctive feature, the new feature will match the old in design, color, texture and, where possible, materials. Replacement of missing features will be substantiated by documentary and physical evidence.

***Local Historic District Design Guidelines***

**Paint**

- \*Use period paint colors and color schemes appropriate to the building's architectural style. Consult the Bloomington Historic Preservation Commission for assistance in choosing colors related to the building's style yet consistent with personal preference.
- \*Avoid painting masonry surfaces such as limestone and most brick surfaces.

*Recommendations:* Staff recommends approval of COA 18-69. Gray appears to be one of the color options associated with Late Victorian historic paint upon independent research. Contrasting trim also appears to be an important element, and petitioner proposes this as well. Petitioner should be careful in evaluating whites to ensure an exact preferred tone.

APPLICATION FORM  
CERTIFICATE OF APPROPRIATENESS

Case Number: 18-69

Date Filed: 9/19/2018

Scheduled for Hearing: September 27, 2018

\*\*\*\*\*

Address of Historic Property: 515 W. 3rd St., Bloomington, IN 47404

Petitioner's Name: Charles and Patricia Russo

Petitioner's Address: 515 W. 3rd St., Bloomington, IN 47404

Phone Number/e-mail: 812-361-4267, chuckrusso429@yahoo.com

Owner's Name: Charles and Patricia Russo

Owner's Address: 515 W. 3rd St., Bloomington, IN 47404

Phone Number/e-mail: 812-361-4267, chuckrusso429@yahoo.com

Instructions to Petitioners

The petitioner must attend a preliminary meeting with staff of the Department of Housing and Neighborhood Development during which the petitioner will be advised as to the appropriateness of the request and the process of obtaining a Certificate of Appropriateness. The petitioner must file a "complete application" with Housing and Neighborhood Department Staff no later than seven days before a scheduled regular meeting. The Historic Preservation Commission meets the second Thursday of each month at 5:00 P.M. in the McCloskey Room. The petitioner or his designee must attend the scheduled meeting in order to answer any questions or supply supporting material. You will be notified of the Commission's decision and a Certificate of Appropriateness will be issued to you. Copies of the Certificate must accompany any building permit application subsequently filed for the work described. If you feel uncertain of the merits of your petition, you also have the right to attend a preliminary hearing, which will allow you to discuss the proposal with the Commission before the hearing during which action is taken. Action on a filing must occur within thirty days of the filing date, unless a preliminary hearing is requested.



Please respond to the following questions and attach additional pages for photographs, drawings, surveys as requested.

A "Complete Application" consists of the following:

1. A legal description of the lot. 013-43780-00 Prospect Hill Pt Lots 2 & 4; (E60') & Vac Alley; L2B

2. A description of the nature of the proposed modifications or new construction:  
Painting the exterior of the house and garage, using historically appropriate paint colors.

---

---

---

---

---

3. A description of the materials used.

We have two potential color combinations that we would like to have reviewed and approved:

1.) Kendall Charcoal Gray (Benjamin Moore HC-166), Amherst Gray (Benjamin Moore HC-167) accent, White Trim

2.) Connected Gray (Sherwin Williams N105-3B), White Trim

All materials will be the highest quality latex based paints. We have selected colors that are already in use in the Prospect Hill neighborhood, and are used in other late Victorian houses from the 1900-1910 era.

4. Attach a drawing or provide a picture of the proposed modifications. You may use manufacturer's brochures if appropriate.

5. Include a scaled drawing, survey or geographic information system map showing the footprint of the existing structure and adjacent thoroughfares, Geographic Information System maps may be provided by staff if requested. Show this document to Planning Department Staff in order to ascertain whether variances or zoning actions are required.

6. Affix at least three photographs showing the existing full facade at each street frontage and the area of modification. If this petition is a proposal for construction of an entirely new structure or accessory building, include photographs of adjacent properties taken from the street exposure.

\*\*\*\*\*

If this application is part of a further submittal to the Board of Zoning Appeals for a Conditional Use or development standard variance, please describe the use proposed and modification to the property which will result.

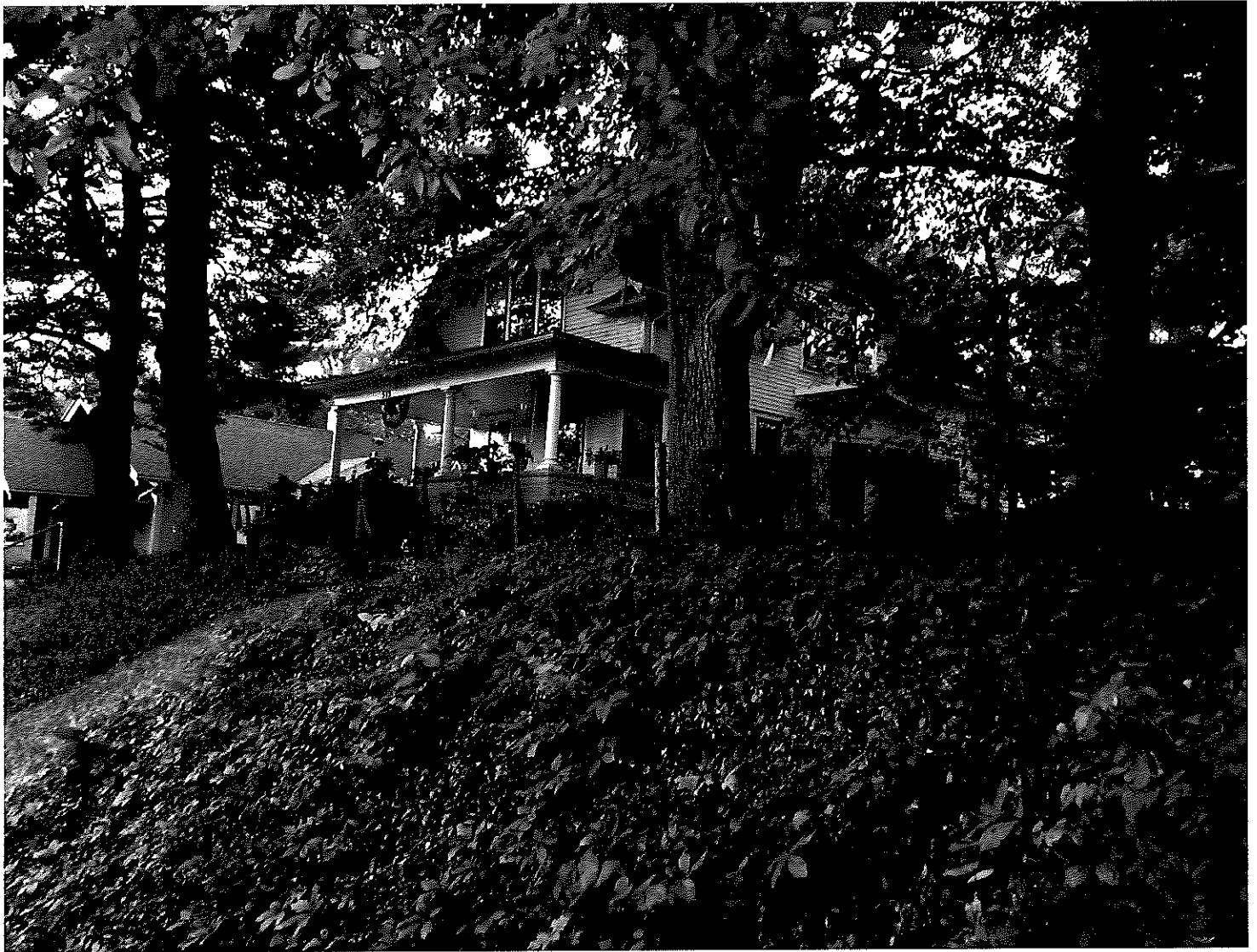



82

SUMMARY

COA 18-70

204 S. Rogers Street – Prospect Hill  
Petitioner: Paul Puzzello

Contributing

105-055-26443

C. 1920



*Background:* Good slightly altered commercial building. Noted for law and social history beyond architecture. Historically known as Bloomington City Garage.

*Request:* Stained wood fence enclosure for trash and electrical panels on north side of building.

*Guidelines:*

***Secretary of the Interior's Standards for Rehabilitation:***

Standard 2: The historic character of a property will be retained and preserved.

Standard 9: New additions, exterior alterations or related new construction will not destroy historic materials, features and spatial relationships that characterize the property. The new work will be differentiated from the old and will be compatible with the historic materials, features, size, scale and proportion, and massing to protect the integrity of the property and its environment.

Standard 10: New additions and adjacent or related new construction will be undertaken in such a manner that, if removed in the future, the essential form and integrity of the historic property and its environment would be unimpaired.

***Local Historic District Design Guidelines***

Paint

\*Use period paint colors and color schemes appropriate to the building's architectural style. Consult the Bloomington Historic Preservation Commission for assistance in choosing colors related to the building's style yet consistent with personal preference.

\*Avoid painting masonry surfaces such as limestone and most brick surfaces.

#### Barns and Sheds

\*Avoid construction of premanufactured sheds and barns uncharacteristic of the surrounding neighborhood.

#### Building Materials

\* Use materials on the exterior of new construction that are compatible with those existing on adjacent buildings in scale, type, texture, size, and color. Exterior finishes should harmonize with and complement existing finishes along the streetscape.

*Recommendations:* Staff recommends approval of COA 18-70. Black was an available paint color of the era and does not detract from the commercial feel of the building. The fence is also vertical board, which is allowed by guidelines.

**APPLICATION FORM  
CERTIFICATE OF APPROPRIATENESS**

Case Number: 18-70

Date Filed: 9/19/2018

Scheduled for Hearing: September 27, 2018

\*\*\*\*\*

Address of Historic Property: 204 S Rogers Street, Bloomington, IN

Petitioner's Name: Paul Puzzello

Petitioner's Address: 3801 N Meridian Street, Indianapolis, IN

Phone Number/e-mail: 317-504-7183 ppuzzello@gmail.com

Owner's Name: David Moore

Owner's Address: 122 W 6th Street, Bloomington, IN

Phone Number/e-mail: 812-606-1228 david@picturagallery.com

Instructions to Petitioners

The petitioner must attend a preliminary meeting with staff of the Department of Housing and Neighborhood Development during which the petitioner will be advised as to the appropriateness of the request and the process of obtaining a Certificate of Appropriateness. The petitioner must file a "complete application" with Housing and Neighborhood Department Staff no later than the Wednesday before a scheduled regular meeting. The Historic Preservation Commission meets the second Thursday of each month at 5:00 P.M. in the McCloskey Room. The petitioner or his designee must attend the scheduled meeting in order to answer any questions or supply supporting material. You will be notified of the Commission's decision and a Certificate of Appropriateness will be issued to you. Copies of the Certificate must accompany any building permit application subsequently filed for the work described. If you feel uncertain of the merits of your petition, you also have the right to attend a preliminary hearing, which will allow you to discuss the proposal with the Commission before the hearing during which action is taken. Action on a filing must occur within thirty days of the filing date, unless a preliminary hearing is requested.

Please respond to the following questions and attach additional pages for photographs, drawings, surveys as requested.

A "Complete Application" consists of the following:

1. A legal description of the lot. (See Attached Deed) \_\_\_\_\_
  
2. A description of the nature of the proposed modifications or new construction:  
The proposed work is a 6'-4" deep x 14'-0" long x 7'-6" high stained wood fence enclosure to  
enclose and screen trash containers and electrical panels. The location would be on the north side of  
building along 4th street between the concrete ramp and the double steel doors. The fence will also not interfere  
with the sidewalk and will have a small landscape strip in front of the fence enclosure.  
\_\_\_\_\_  
\_\_\_\_\_  
\_\_\_\_\_
  
3. A description of the materials used.  
treated wood stained ebony with 6" wide vertical planks.  
\_\_\_\_\_  
\_\_\_\_\_  
\_\_\_\_\_  
\_\_\_\_\_  
\_\_\_\_\_  
\_\_\_\_\_
  
4. Attach a drawing or provide a picture of the proposed modifications. You may use manufacturer's brochures if appropriate.
  
5. Include a scaled drawing, survey or geographic information system map showing the footprint of the existing structure and adjacent thoroughfares, Geographic Information System maps may be provided by staff if requested. Show this document to Planning Department Staff in order to ascertain whether variances or zoning actions are required.
  
6. Affix at least three photographs showing the existing full facade at each street frontage and the area of modification. If this petition is a proposal for construction of an entirely new structure or accessory building, include photographs of adjacent properties taken from the street exposure.

\*\*\*\*\*

If this application is part of a further submittal to the Board of Zoning Appeals for a Conditional Use or development standard variance, please describe the use proposed and modification to the property which will result.

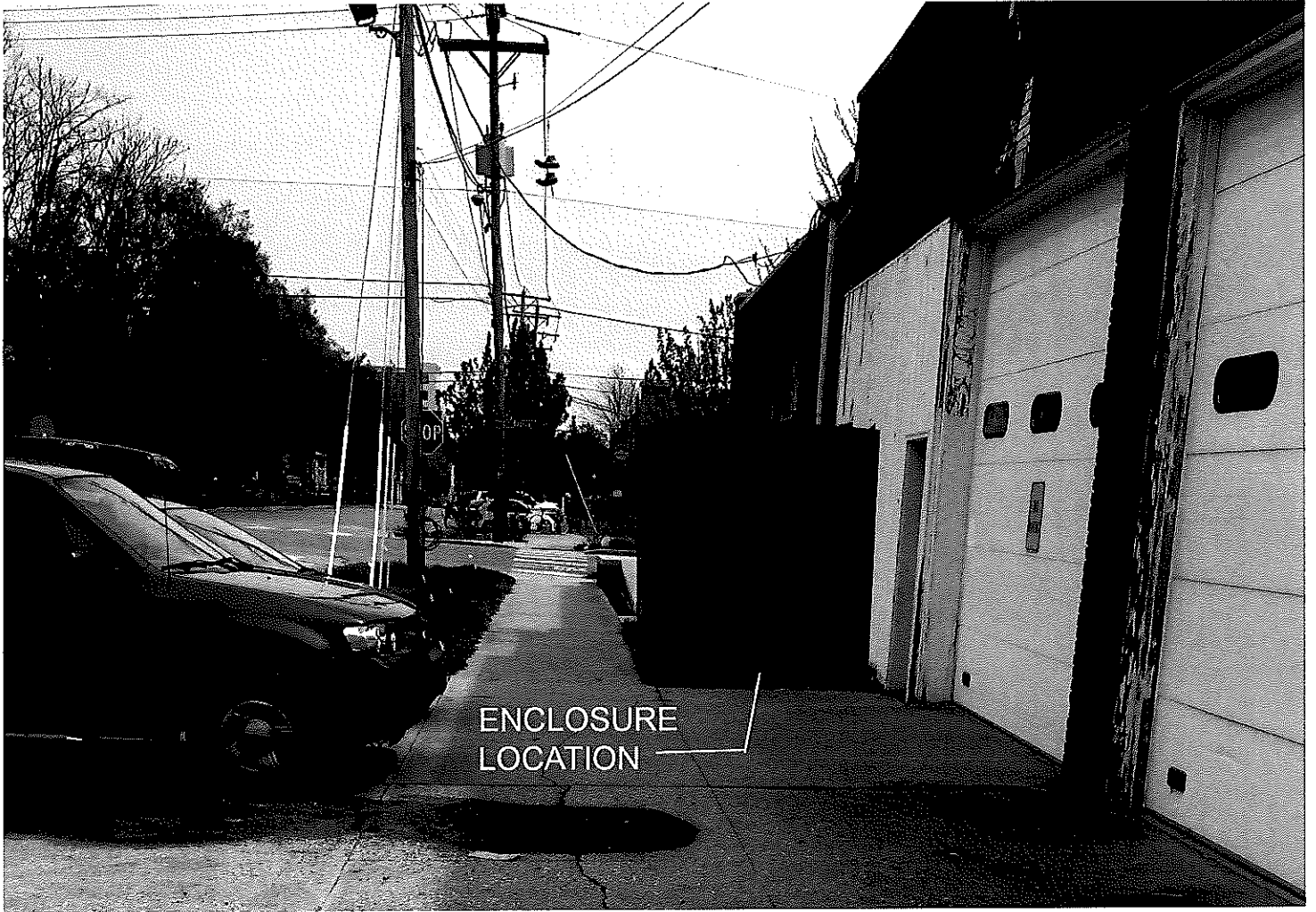





FENCE NORTH ELEVATION

SCALE: 1/2" = 1'-0"

BLACK STAINED VERTICAL  
1 X 6 TREATED WOOD BOARDS

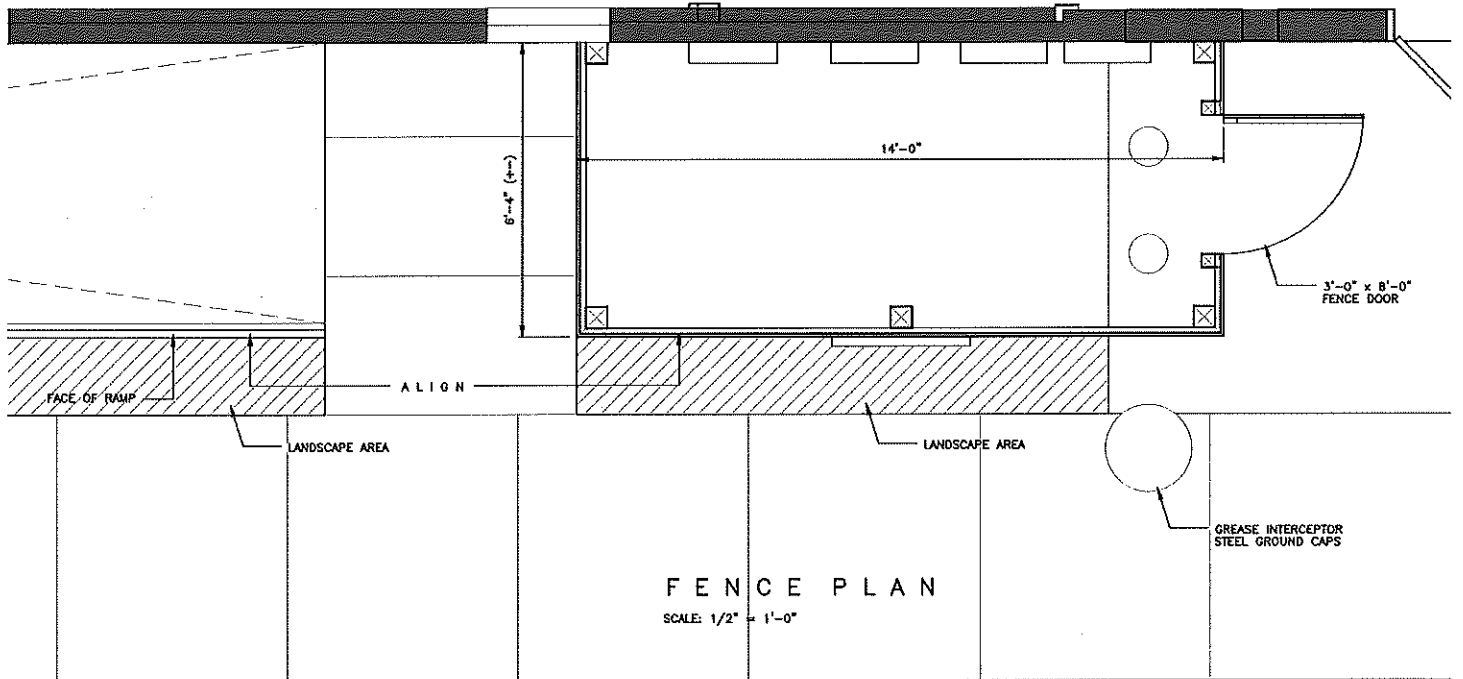

FENCE PLAN

SCALE: 1/2" = 1'-0"

GREASE INTERCEPTOR  
STEEL GROUND CAPS



## SUMMARY

### **Demo Delay 18-36**

910 N. College Avenue  
Petitioner: Jeff Fanyo (Bynum Fanyo and Associates, Inc.)

Contributing

IHSSI #: 105-055-35906

c. 1940



*Background:* This structure is a good condition slightly altered commercial building of concrete and stone. Doors and windows other than an original fixed 3-pane window have been replaced.

*Request:* Full demolition of structure. New rooming house to be built.

*Guidelines:* According to the demolition delay ordinance, BHPC has 90 days to review the demolition permit application from the time it is forwarded to the Commission for review. The BHPC may thus employ demolition delay for 90 day from the date the application was received and may request an additional 30 days if necessary for further investigation within the first 30 days of the review period. During the demolition delay waiting period, the BHPC must decide whether to apply Local Designation to the property.

*Recommendations:* Staff recommends releasing demolition delay 18-36. The contributing structure has historic worth with its limestone front and existence as a simple commercial building in context of the nearby wooded railroad bridge and other commercial stores but is not a particularly impressive example with its plainness and alterations and with much of the immediately surrounding area having converted to residential and/or other uses and/or more modern buildings.

Monroe County, IN  
910 N College AVE  
39 DEGREES NORTH (855) GIS-3939

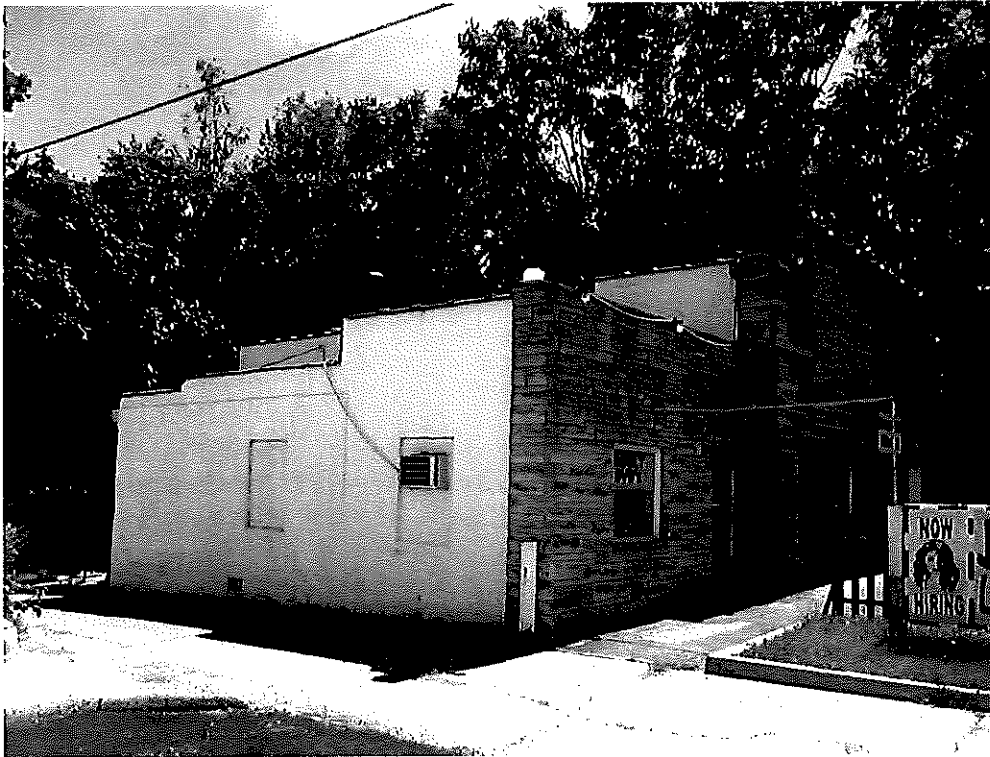
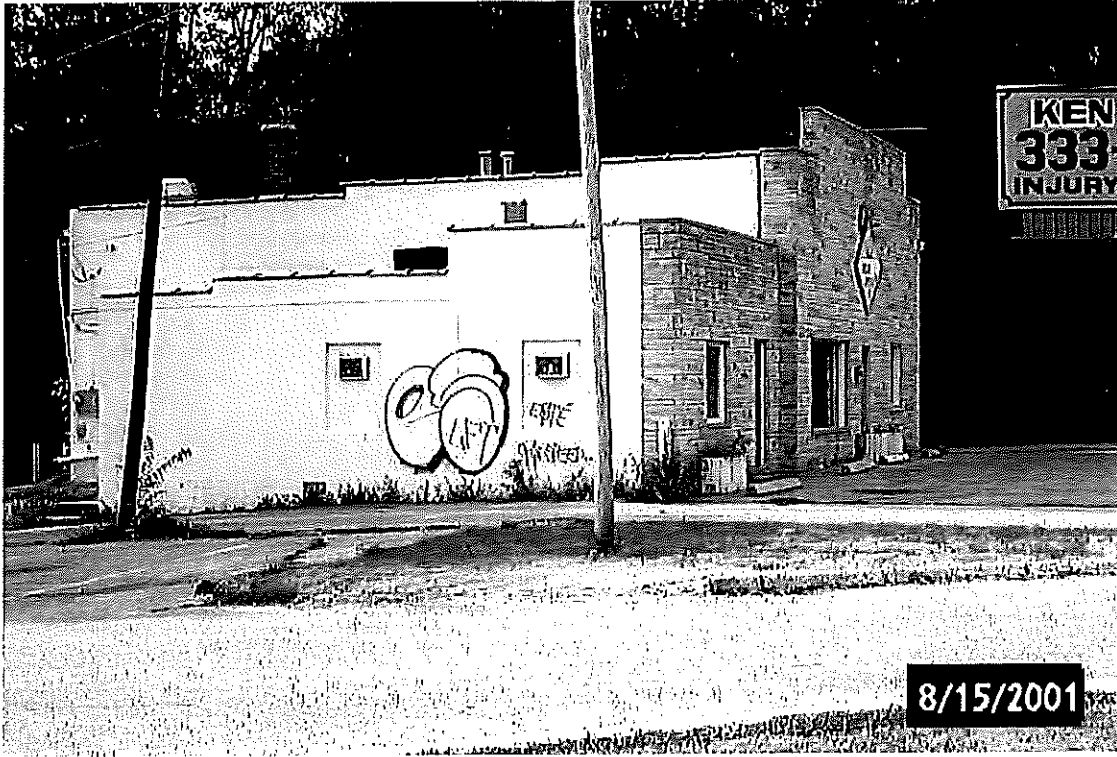

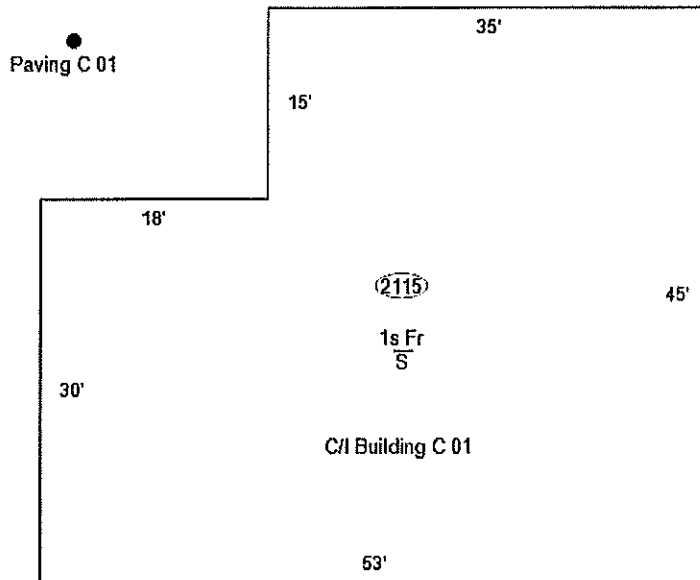
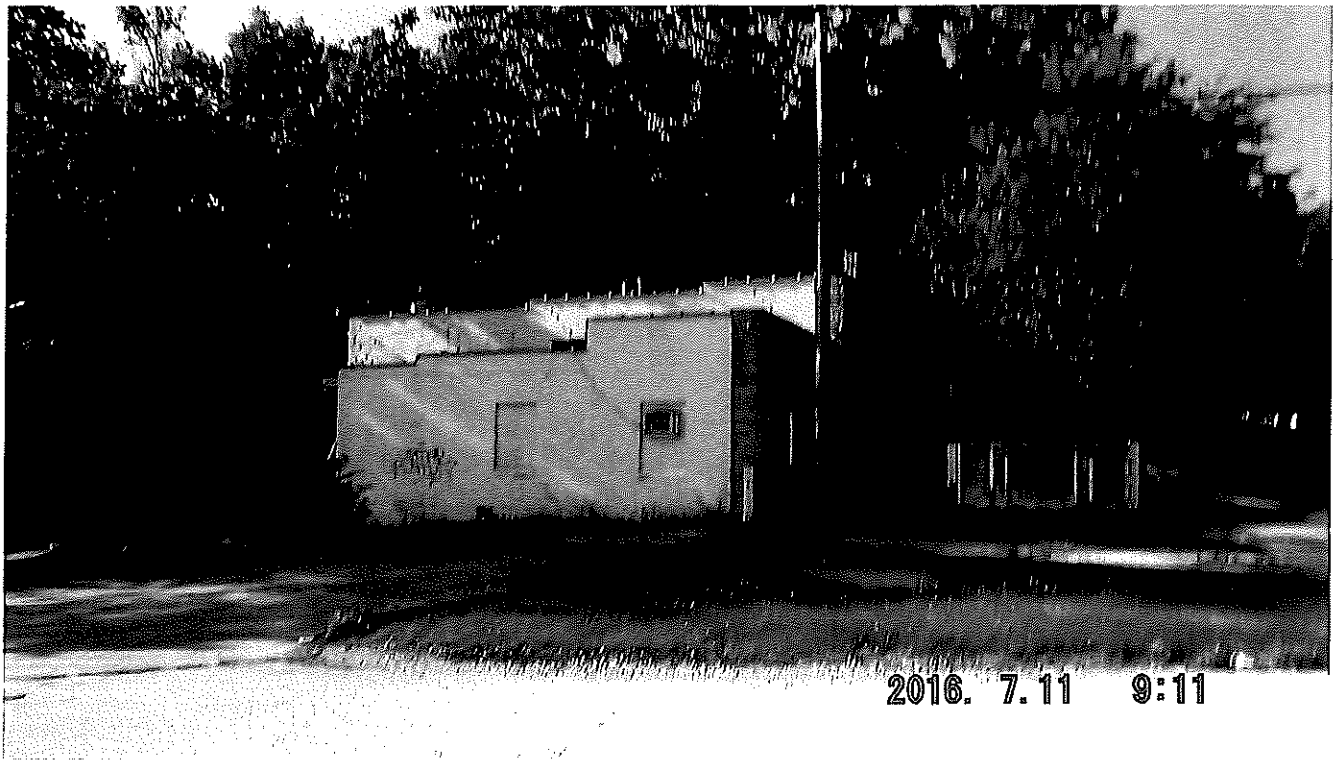

Parcel Information

---

# **Bloomington Historic Preservation Commission (“Commission”) Rules and Procedures**

## **Article I: Meetings**

- A. The Commission shall meet on the second and fourth Thursday of every month at 5:00 P.M. Meetings shall be in the McCloskey Conference Room of Showers City Hall unless noticed at another location.
- B. Notices of Meetings shall be submitted by the City of Bloomington Housing and Neighborhood Development Department (“HAND”) to the newspaper and posed in the Municipal Building at least 48 hours before each meeting.
- C. Special meetings may be called by the chairperson and shall be called upon request of two voting members of the commission. Three days notice is required.
- D. The agenda shall be set at least six days before each meeting and mailed to members.
- E. A majority of voting members shall constitute a quorum.
- F. All decisions, votes, recommendations, motions and communications of the Commission shall be by roll call. The vote of each member of the Commission shall be entered in the records of the Commission and shall appear in the minutes.
- G. No member of the Commission shall participate in the decision of the Commission involving any matter in which that person is directly or indirectly financially interested, other than the preparation of a Master Plan. In the event that any member disqualifies himself or that any member’s eligibility is challenged by members of the public such fact shall be entered on the records of the Commission and shall appear in the minutes
- H. As soon as possible, a summary of the minutes of the proceedings shall be made available to each member of the Commission. The minutes shall include a record of the Commission members and visitors present.
- I. All minutes or tape recordings of the proceedings and exhibits submitted by petitioners, remonstrators and staff shall be public records and shall be filed in the HAND office. The materials shall be part of the case and all such materials shall be held by the HAND office for a period of at least two years.
- J. The final disposition of any request, petition or resolution shall be in terms of a motion to grant, deny, or continue by the Commission. Additionally, the members of the Commission may attach such conditions to a motion as are deemed necessary to promote the purposes of Title 8 of the City of Bloomington Municipal Code.
- K. No petition or request will be heard unless the petitioner or his/her authorized representative is present at the time their case is called to be heard. The petition will be moved to the end of the agenda if a petitioner has not appeared in time for the hearing. If the petitioner does not appear, the case will be continued to the next noticed meeting. A petitioner who is unable to attend the hearing on his or her petition may request that the Staff Liaison present the petition to the Commission. Petitioner shall be clearly told that Staff will merely present but not advocate for the petition and that petitioner will have thereby waived any real or perceived conflict. For purposes of these Rules and Procedures, no Demolition Delay case will be considered a petition, however members of the Commission may decide to delay the discussion until enough information is presented
- L. Upon resignation of a Commission member, the Mayor within 90 days shall appoint, a new member for the remainder of the resigning member’s term.

## **Article II: Officers**

- A. Annually at its first meeting of the year, the Commission shall select by majority vote of its members a Chair and Vice-Chair, who shall each serve for one year and who may be reelected to second one-year terms.
- B. The Chair shall preside over Commission meetings and on behalf of the Commission has the authority to take action on behalf of the Commission as authorized herein, and shall exercise general supervision over the administration of affairs, including entering into contracts and agreements, the appointment of subcommittees and representatives, the determination of points of order and procedure, and the signing of all official documents. The Vice-Chair shall have authority to act as Chair of the Commission during the absence or disability of the Chair. In the case of the resignation or death of the Chair, the Vice-Chair shall succeed to the Office of Chair until a new Chair is selected from the membership at the next duly noticed general meeting.
- C. The Vice Chair, with the assistance of HAND staff, shall be responsible for supervising the keeping of an accurate and complete record of all Commission proceedings, including keeping of records and minutes, the custody and preservation of all papers and document of the Commission, the maintenance of a current roster and qualifications of members, and the authority to certify all official acts on behalf of the Commission
- D. The City's Director of Planning or his designee shall appear at meetings and assist the Commission by presenting factual opinion on significant issues.

## **Article III: Filing and Processing of Petitions:**

- A. Petitions for Historic Designation or Certificates of Appropriateness shall be made by the petitioner at least ten (10) days prior to a Commission Meeting on forms approved by the Commission which are available on request in the Office of Housing and Neighborhood Development.
- B. Notices shall be posted no later than six (6) days before the Historic Preservation Commission hearing for designation of a property. For regular meetings the 48 hour public notice requirement shall be honored.
- C. A petition may be withdrawn at any time by the petitioner.

## **Article IV: Certificates of Appropriateness**

- A. The Commission shall consider and may make final disposition of said petition at any properly scheduled meeting, but in no case more than thirty days after the acceptance of the complete application as certified by the Vice-Chair. However, the HAND staff may notify the petitioner that the petitioner may choose to attend a preliminary hearing to advise the Commission of the merits of the submittal in anticipation of the formal hearing and disposition of the request.
  - 1. An application for Certificate of Appropriateness shall be subject to the following requirements:
    - a. No fee shall be charged for the application.

- b. The application shall be accompanied by appropriate sketches, photographs, descriptions, and other information which the Commission finds necessary for its decision.
  - c. The Commission must state findings in report form addressing the criteria in Title 8. The Commission may attach conditions to the approval.
  - d. A Certificate of Appropriateness shall be issued by the Commission, if approved by the Commission, or if the petition is not acted upon by the Commission within thirty (30) days after it is filed.
  - e. The Commission may grant an extension of the thirty days' limit if the applicant agrees with the extension.
  - f. Expiration of a Certificate of Appropriateness: The Certificate of Appropriateness shall expire two years after issuance, unless at the time the Certificate is approved, the Commission approves an extension upon the request of the petitioner.
  - g. Right to Commission Review: In any case where an applicant does not receive a Certificate of Appropriateness or otherwise feels aggrieved by an action of the HAND staff, the applicant shall have the right to a review by the Commission. If an applicant feels aggrieved by an action of the Commission, the applicant shall have the right to a review by the Commission but only upon submission of new information.
- B. The Vice-Chair with the assistance of HAND staff shall be responsible for completion of the Commission report and creation of the Certificate of Appropriateness. A copy of the Certificate of Appropriateness shall be submitted to the petitioner. The original shall be kept with case records in the HAND Office.
- C. The Vice-Chair with the assistance of HAND staff shall also be responsible for notifying the petitioner of the Commission's decision.
- D. A Certificate of Appropriateness is not required for the following activities:
1. Routine maintenance as defined in Title 8: Work which would not require a building permit and any change that is not construction, removal, or alteration.
  2. The installation of a single wall mounted mailbox near the main entrance on the front of the structure.
  3. The removal of an inappropriate fence type: chain link, board and batten, basket weave, split rail or stockade.
  4. Repair or replacement of existing sidewalks, driveways, and steps with the same materials.
  5. Roof repair where the surface matches existing roof materials, including both flat and shingled surfaces.
  6. Replacement or installation of mechanical equipment, skylights, or vents on a flat roof provided the new element is not visible from the public way.
  7. Ground installation of central air conditioning equipment provided that it is screened and not visible from the public way.
- E. Staff may approve or deny Certificates of Appropriateness for certain minor requests by property owners as set forth below. Certificates approved at the staff level, along with staff's findings of fact, shall be listed on the agenda for the next monthly meeting of the Commission.



1. Staff has approval authority regarding changes to:
  - a. pavement or exterior mechanicals or reception devices
  - b. trees (removal)
  - c. fencing
  - d. sidewalks
  - e. paving materials
  - f. patios or decks
  - g. placement of temporary or removable structures such as sheds or playground equipment
  - h. paint color
  - i. changes authorized for staff level approval by Design Guidelines approved by the Commission
2. Staff shall not be authorized to grant or deny Certificates of Appropriateness for the following activities within a historic or conservation district:
  - a. demolition of a building, structure, or site
  - b. moving of a building or structure
  - c. construction of an addition to a building or structure
  - d. construction of a new building or structure
3. An owner or any interested party aggrieved by a staff level decision may appeal the staff decision to the Commission.
  - a. Such appeal shall be filed with HAND within five days of the staff level decision being rendered.
  - b. The filing shall specify the grounds for the appeal.
  - c. The appeal shall be filed on the form established by the Commission.
4. At the request of staff, an application for staff level approval may be forwarded to the full Commission at the next regularly scheduled meeting for full Commission review and consideration. In no case shall the time for approval of a completed application exceed 30 days.
5. Staff shall consist of and be limited to those persons employed by the City's HAND whose job description includes the requirement that he or she assist the Commission.

#### **Article V: Historic Designation**

- A. The Commission may initiate or accept by petition of owners in fee simple, a request for designation of an Historic District or Conservation District.
  1. The Commission shall prepare a map based upon a survey conducted or adopted by the Commission which documents historic properties within the corporate limits of the City of Bloomington.

2. The Commission may divide the district into secondary and primary areas.
  3. The Commission shall classify all buildings and structures within the districts as Outstanding, Notable, Contributing or Non-contributing.
  4. A report shall accompany all petitions to the Common Council for designation citing cause for accepting the district under the criteria in Title 8 of the Municipal Code.
- B. After three years, the status of a Conservation District will be reviewed by the Commission. Property owners will be notified 185 days before the 3<sup>rd</sup> anniversary of designation as a conservation district and asked to vote on whether to remain a conservation district or be elevated to a historic district Unless 51% of the owners object in writing to the Commission, the Conservation District will be elevated to historic district status. Otherwise it will remain a conservation district. All owners shall have one vote, regardless of how many parcels or units they own in the district.
  - C. A public hearing shall be held by the Commission to allow for public comment. Such public comment may be held separately or in conjunction with the Commission meeting where the action on the district is to occur. Other meetings involving the residents and owners, and Common Council members may be held to educate and publicize the proposed district.
  - D. The Vice-Chair with the assistance of HAND staff shall be responsible for forwarding the findings of the Commission to the Common Council for final vote.
  - E. The Commission recommends that design guidelines be adopted for a district, whether at the time of the designation or at a later time.
  - F. The Commission may declare that a proposed district be placed under interim protection until action of the Common Council.
    1. After declaring interim protection, staff shall notify the owner(s) by certified mail, to be postmarked no later than two days after the hearing at which the action was taken.
    2. The written notice shall include the appropriate ordinance citation, a description of the restrictions that apply to the property or properties, and advise the owner(s) that the restrictions are temporary until the action of the Common Council.
    3. An owner may apply for a Certificate of Appropriateness during interim protection but it will be invalid unless and until the district is approved by the Common Council. The Commission and owner(s) may use this process to come to an agreement on proposals for a building's future use and disposition.

## **Article VI: Committees**

- A. A Historic District Committee comprised of three voting members shall be appointed by the Chair immediately after the first meeting of the year. It shall be the duty of this committee to:
  1. Review applications for historic districts submitted by property owners for consistency with guidelines and standards.
  2. Prepare criteria and standards on which the Commission bases its actions, and define elements the Commission should consider of particular importance to a specific district being proposed.
  3. Present to the Commission proposals for the adoption of new districts and landmarks, based upon special significance or impending threats.

- B. Such other Committees, standing or special, as the Commission from time to time deems necessary to carry on the work of the Commission, may be created and members appointed by the Chair. The Chair and the advisory members of the Commission shall be ex-officio members of such committees.

**Article VII: Maintenance**

- A. Upon presentation of supporting evidence, the Commission may act upon reports of neglect and/or lack of maintenance that endangers significant architectural details of a property designated pursuant to Title 8 of the BMC.
  - 1. Before any official action by the Commission, staff shall notify the property owner of the Commission's intent, giving a minimum of 21 days' advance notice.
  - 2. The owner or his or her agents may appear to present plans or evidence of upkeep at the next regular meeting of the Commission after such notice is made.
  - 3. After consideration of all the evidence, the Commission may find that a building's condition constitutes a threat to the historic fabric of the area where the building is located and may move to forward these findings to the City's Legal Department for appropriate legal action.

**Article VIII. Procedure for the review of a National Register nomination**

- A. From time to time the Commission may receive applications for listing a structure or a district on the National Register of Historic Places. Within five days of receiving an application, a copy will be sent to the Indiana Division of Historic Preservation and Archaeology. After reviewing the completeness of the application according to the U.S. Department of the Interior's Bulletin #15, the Commission will duly notice a public hearing. Staff will draft a report applying the National Park Service criteria for evaluating whether to place a structure or district on the National Register. The public hearing will be noticed according to the following procedure, as fits the circumstances:
  - 1. Letter announcing the nomination sent to the owner of an individual property not located in a historic district
  - 2. Letter announcing the nomination sent to the owner(s) of property located in a historic district.
  - 3. Letter announcing the nomination to the local authority (Mayor)
  - 4. Letter announcing the nomination to the County Commissioners,
  - 5. Legal Notice placed in the paper ( if under 50 property owner)
- B. At an appropriately noticed public meeting (notice shall be not less than 30 days before the local hearing and not more than 75 days before the State Review Board Hearing) a determination will be made as to whether the structure or district meets the criteria for inclusion. The Commission's findings and the report will be forwarded to the State Review Board for their consideration. Following the notification by the Keeper of the National Register that a property has been listed, the following notices will be made:

The listing will be noticed according to the following procedure:

- 1. Letter of notification to all owners whose property is affected of the inclusion on the list.

Legal notice placed in local newspaper to announce the listing (if it contains more than 50 properties or letter #6 must be sent to each owner (if it contains fewer than 50 property owners)

# NATIONAL ALLIANCE OF PRESERVATION COMMISSIONS CODE OF ETHICS FOR COMMISSIONERS AND STAFF

## Preamble

Preservation commissions have been established by local governments throughout the United States to promote the preservation and appropriate development of heritage resources in their communities. The National Alliance of Preservation Commissions (NAPC) is the only organization devoted solely to representing the nation's preservation commissions. Its mission is "to build strong local preservation programs through education, advocacy and training." As part of that mission, the NAPC has developed this Code of Ethics to promote and maintain the highest standards of honesty, integrity and professionalism among the commissioners and staff who serve their communities through preservation commissions.

These principles are derived from general societal values and recognized principles of professional responsibility. As societal values compete, so may ethical principles. The need for full public disclosure may compete with the need to respect confidential information, for example. The ethical commissioner or staff member must carefully balance various public and private interests based on facts and context of each situation guided by the commitment to serve the public interest.

Individual commissioners should be knowledgeable, accurate, honest and forth-right in their dealings with other commissioners, local elected officials and staff, applicants and the general public. Although not elected by the public, preservation commissioners are accountable for their actions in the communities they serve.

This Code of Ethics comprises guidelines for ethical conduct organized under three main categories:

*Responsibility to the Community*  
*Responsibility to the Profession*  
*Standards of Professional Conduct*

Under each category are statements of principle to guide preservation commissioners and staff in choosing ethical courses of action for heritage preservation in their communities. The NAPC endorses this Code as the ethical benchmark to which all its members should aspire. In the absence of professional licensure for preservation commissioners and staff, the adherence to a code of ethics is a matter of personal responsibility. However, preservation commissions may wish to adopt these principles and standards as a guide. Although stated in the plural, each suggested rule also applies to an individual commissioner or staff member.

## **Responsibility to the Community**

*The most effective historic preservation takes place locally, and all preservation commissioners and staff should remember that it is their duty, as public servants, to advance the greater good of the community.*

1. Commissioners and Staff should be advocates for the community's heritage resources, striving to protect their integrity while recognizing the rights of citizens, individually and collectively, to their beneficial use and enjoyment.
2. Commissioners and Staff should promote public awareness, appreciation, access and support for the preservation of heritage resources.
3. Commissioners and Staff should develop standards and guidelines that are appropriate for the resources and protect the community's unique character, environment and quality of life.
4. Commissioners and Staff should respect the diversity of heritage resources that may hold different meanings for various groups and communities.
5. Commissioners and Staff should respect the public's right to know by providing full, clear and accurate information and observing both the letter and spirit of open meetings and open records law.
6. Commissioners and Staff should provide opportunities for meaningful public participation in the work of the commission.
7. Commissioners and Staff should make timely, fair, informed, and impartial decisions that guarantee citizens' rights to due process and equal protection under the law.
8. Commissioners and Staff should be sensitive to the interrelatedness of their decisions and the long-term implications for the resources and the community.
9. Commissioners and Staff should seek compromises or search for alternatives where necessary to achieve overall preservation goals and provide substantial justice for citizens.
10. Commissioners and Staff should recognize that the historic built environment changes over time and encourage new development that respects the historic character and fabric that preceded it.
11. Commissioners and Staff should continually evaluate and update their plans, ordinances, standards, guidelines and procedures to ensure they meet the community's current and future needs.
12. Commissioners and Staff should always strive to make decisions that are in the best interest of the community.

### **Responsibility to the Profession**

*Preservation commissioners and staff are drawn from many disciplines and backgrounds. The common thread that joins them is their interest and commitment to preserve heritage resources in their communities. A multi-disciplinary profession has developed over the years from the historic preservation movement, and commissioners and staff have an obligation to advance the best interests of this profession in the context of their commission work.*

1. Commissioners and Staff should be mindful that they are representatives of the greater local, state, and national preservation community and conduct themselves in a way that brings credit to their commission and the profession.
2. Commissioners and Staff should share their knowledge and experience and contribute to the development of other colleagues, particularly newly appointed commissioners, students, and interns.
3. Commissioners and Staff should actively promote heritage preservation and strive to increase the involvement of underrepresented groups.
4. Commissioners and Staff should treat fairly and comment responsibly on the professional views of colleagues and members of other professions.

5. Commissioners and Staff should work collaboratively with related professionals and professional organizations who actions also affect heritage conservations including, but not limited to, planners, code officials, architects, landscape architects, archaeologists, attorneys, realtors, and developers.
6. Commissioners and Staff should treat fairly and comment responsibly on the professional views of colleagues and members of other professions.
7. Commissioners and Staff should render all practicable assistance to other colleagues and organizations in an emergency when heritage resources are at risk.
8. Commissioners and Staff should acquire a depth of knowledge that will enable them to explain to others the role of heritage preservation in a complex, modern world.
9. Commissioners and Staff should recognize that the field of heritage preservation is constantly evolving and actively pursue continuing educational opportunities in order to maintain, refine and enhance their capabilities as practitioners.

### **Standards of Professional Conduct**

*As public servants, commissioners and staff are expected to conduct themselves in accordance with the law. These standards set forth both a baseline for such legal conduct as well as aspirational goals for ethical behavior that may require a conscientious effort to attain.*

1. Commissioners and Staff should thoroughly understand the legal framework of heritage preservation and consistently operate within the bounds of their authority and responsibility under the law.
2. Commissioners and Staff should treat all citizens fairly, impartially and with respect, and refrain from discrimination or harassment of any kind.
3. Commissioners and Staff should not accept gifts or favors under any circumstances where it might appear that acceptance could influence their judgement.
4. Commissioners and Staff should disclose all personal or financial advantages that might accrue to them, their business interests or family members either directly or indirectly from a recommendation or decision.
5. Preservation Commissioners and Staff who have an actual or apparent conflict of interest in a matter coming before them should recuse themselves entirely from deliberations and decisions.
6. Commissioners and Staff are obligated to utilize their knowledge and experience to make decisions and therefore should abstain from participating and voting only in cases of a *bona fide* conflict of interest.
7. Commissioners and Staff should not disclose confidential information obtained in the course of their duties, except as require by the law, or use confidential information to further a personal interest.
8. Commissioners and Staff should not abuse their office by advancing an agenda that is not in the best interest of the community or heritage preservation.
9. Commissioners and Staff should seek the advice of colleagues or other professionals on matters that fall outside their expert knowledge or competence.
10. Commissioners and Staff should be consistent in their actions and recommendations, treating similarly situated properties similarly and providing clear explanations when different treatment is required.
11. Commissioners and Staff should reveal illegal conduct on the part of other commissioners, staff, officials, applicants or their representatives to an appropriate higher authority.

12. Commissioners and Staff should not participate in deliberations or decisions without adequate preparation and knowledge of the matter before them.
13. Commissioners and Staff Should avoid dishonesty, never misrepresenting facts or distorting information to achieve a desired outcome.
14. Commissioners and Staff should recognized the uniqueness of heritage properties, applying preservation theories, methods, and standard appropriate to each particular case.
15. Commissioners and Staff should be sensitive to ethical issues and ensure they are raised, critically analyzed, and addressed by the commission and other appropriate authorities.

*This Code of Ethics was developed by members of the NAPC through an interactive process beginning with a series of facilitated sessions held during the July 2006 NAPC FORUM in Baltimore, MD. The resulting set of principles was further developed and refined by members during the following three-month period leading up to the November 2006 annual meeting of NAPC in Pittsburgh, PA. The effort was supported by the Board of Directors and staff of NAPC and coordinated by Professor James L. Reap, an attorney and member of the Board, with the involvement of the Historic Preservation Advocacy and Professional Development class in the Master of Historic Preservation Program at the University of Georgia. The NAPC would like to acknowledge the organizations whose guidelines and materials were relied on in developing this code: the American Institute of Architects (AIA), American Planning Association (APA), American Institute of Certified Planners (AICP), American Institute for Conservation of Historic and Artistic Works (AIC), and International Council on Monuments and Sites (ICOMOS).*