

CITY OF BLOOMINGTON



PLAN COMMISSION

December 13, 2021

5:30 p.m.

Zoom Meeting:

<https://bloomington.zoom.us/j/85654574138?pwd=NUtOem1VMjdnT1RVdnRqTmpjNmcrdz09>

[Meeting ID: 856 5457 4138](#)

[Passcode: 593908](#)

**CITY OF BLOOMINGTON
PLAN COMMISSION
December 13, 2021 at 5:30 p.m.**

❖**Virtual Meeting:**

<https://bloomington.zoom.us/j/85654574138?pwd=NUtOem1VMjdT1RVdnRqTmptNmcrdz09>

Meeting ID: 856 5457 4138

Passcode: 593908

ROLL CALL

MINUTES TO BE APPROVED: November 18, 2021

REPORTS, RESOLUTIONS AND COMMUNICATIONS:

PETITION WITHDRAWN:

DP-20-21 **Bledsoe Riggert Cooper James**
3111 S Walnut Street Pike
Request: Primary Plat approval of 33 single family lots on 10.34 acres in Ivy Chase
Subdivision Phase II.
Case Manager: Eric Greulich

PETITION CONTINUED TO: January 10, 2022

PUD/DP-24-21 **Robert V Shaw**
N Prow Road: 3500 block of N Hackberry Street
Request: Petitioner requests Final Plan and Preliminary Plat amendment for
Ridgefield PUD and Subdivision Section V.
Case Manager: Jackie Scanlan

CONSENT AGENDA:

DP-35-21 **Joe Kemp Construction**
2400 S Adams Street
Request: Secondary plat approval of 9 single family lots and 2 common area
Lots in a Planned Unit Development (PUD).
Case Manager: Eric Greulich

DP-39-21 **Public Investment Corporation**
2700 W Tapp Road
Request: Secondary plat approval to allow an 8-lot subdivision of 29.76 acres in
the Mixed-Use Employment (ME) zoning district.
Case Manager: Eric Greulich

PETITIONS: December 13, 2021

SP-37-21 **Cedarview Management**
3391 S Walnut Street
Request: Major site plan approval to allow the construction of a 34,000 sq.ft. office

***Next Meeting January 10, 2022*

Last Updated: 12/10/2021

Auxiliary aids for people with disabilities are available upon request with adequate notice.

Please call [812-349-3429](tel:812-349-3429) or e-mail human.rights@bloomington.in.gov.

building for a behavioral health facility for children with autism in the Mixed-Use Corridor (MC) zoning district.

Case Manager: Eric Greulich

SP-40-21

University Properties IX, LLC

307, 319, 401, 403, 405, 407, 409, and 421 E. 19th St. (19th & Dunn)

Request: Major site plan approval for a new 6-story, mixed-use structure in the Mixed-Use Student Housing (MS) zoning district.

Case Manager: Keegan Gulick

Petition Map: <https://arcg.is/1vH1XH>

****Next Meeting January 10, 2022**

Last Updated: 12/10/2021

Auxiliary aids for people with disabilities are available upon request with adequate notice.

Please call [812-349-3429](tel:812-349-3429) or e-mail human.rights@bloomington.in.gov.

**BLOOMINGTON PLAN COMMISSION
STAFF REPORT
Location: 2400 S. Adams Street**

**CASE #: DP-35-21
DATE: December 13, 2021**

PETITIONER: Joe Kemp Construction
213 E. Kirkwood Ave., Bloomington, IN

CONSULTANTS: Smith Design Group, Inc.
2755 E. Canada Drive, Bloomington

REQUEST: The petitioner is requesting secondary plat approval for 9 single family lots and 2 common area lots in a Planned Unit Development zoning district.

BACKGROUND:

Area: 12.662 acres
Zoning: Planned Unit Development
Comp Plan Designation: Urban Residential
Existing Land Use: Undeveloped
Proposed Land Use: Dwelling, Single-family
Surrounding Uses: North – Commercial/Industrial (Thomson PUD)
 West – RCA Community Park
 East – Dwelling, Single-family
 South – Dwelling, Single-family

REPORT: The property is located at 2400 S. Adams Street and is on Parcel O of the Sudbury PUD. Surrounding land uses include Summit Elementary School to the east, Summit Ridge attached single family units and the Woolery Mill to the south, a single family residence to the west, and the vacant Parcel N of the PUD to the north. This property was formerly a mix of pasture and wooded areas with some scattered karst features.

The Sudbury PUD was approved in 1999 under case #PUD-80-98 and this site received PUD Preliminary Plan approval and preliminary plat approval under case #PUD-08-15. A secondary (final) plat approval was given for Phase 2 of this development under case #DP-22-19. Three sections of Phase 2 have been platted, with the last section recorded on August 2, 2019. A grading permit has been issued to allow site grading and infrastructure installation on Phase 1 only. Since it has been more than 18 months since any section of the Phase 2 approved secondary (final) was recorded, the portions of the secondary plat that have not been recorded have expired and must be reapproved.

The petitioner is requesting secondary plat approval to plat the remaining portion of the development under Phase 2 Section 4. This plat includes 9 single family lots and 2 common area lots. Common area lot #18 and 20 are being set aside to meet environmental preservation requirements and contain several karst features and a riparian buffer. Common area lot #23 which was platted with Phase 1, contains the detention pond for the entire development and was established under a previous plat (PUD-07-16). Right-of-way dedication for the extension of Adams Street is also required with this plat, the final section of Phase 2, and has been shown.

This phase will be primarily accessed by an extension of a new public street connection (Ezekiel Drive) to Adams Street to the east, as well as by connections to the public streets in Summit Ridge

to the south. With this project Adams Street will be extended and a total of 75' of right-of-way will be dedicated for its extension. All of the internal streets proposed with this development would be public. A road stub was platted with previous phases to the adjacent Parcel N to the north to provide future road connections.

The petitioner has begun work in this section of Phase 2 without a grading permit, and is working with the Department and the Engineering Department to comply with grading permit requirements.

SECONDARY PLAT REVIEW: The Plan Commission shall review the secondary plat petition and approve, approve with conditions, or deny the petition in accordance with Section 20.06.040(g) (Review and Decision), based on the general approval criteria in Section 20.06.040(d)(6)(B) (General Compliance Criteria).

20.06.040(d)(6)(B) General Compliance Criteria

- i. Compliance with this UDO
- ii. Compliance with Other Applicable Regulations
- iii. Compliance with Utility, Service, and Improvement Standards
- iv. Compliance with Prior Approvals

PROPOSED FINDING: The petition meets all of the requirements and standards of the UDO and the approved PUD District Ordinance. No problems have been identified with meeting all stormwater and utility connections. This is the last section in the last phase of this development and is consistent with what was approved with the final plan, primary plat (preliminary), and previously approved secondary (final) plat.

PLAT REVIEW:

Uses/Development Standards: The Sudbury PUD outlined specific standards for development based on the land use type. The single family lots are governed by the “small lot single family detached” standards of the Sudbury PUD. The sideyard setback is 6' regardless of story. The PUD required a 15' build-to-line for the single family residences and the Plan Commission approved an additional standard to require front loaded garages to be 20' behind the front of the residence.

Pedestrian Facilities/Alternative Transportation: All of the internal streets will be public with 50' of right-of-way and 5' sidewalks and 5' tree plots. Adams Street is required to be extended and bonded for with this petition and will have a 5' sidewalk on the west side of the street with an 8' wide asphalt sidepath on the east side. An 8' wide asphalt sidepath was approved along the north side of the Ezekiel Drive to provide a connection from the Clear Creek trail to Adams Street, but was installed as an 8' wide concrete sidepath instead. Although that deviation from the approved plans was not approved, the Department does not find any issues with allowing the concrete to remain. The PUD also required an extension of Clear Creek Trail to go across the west side property to provide a connection from the Woolery Mill property to other portions of the Sudbury PUD to the north and this was shown with the Phase 3 plat.

Utilities: Sanitary sewer mains for this phase will be extended from Summit Ridge to the south. The water mains will be extended from Adams Street and Countryside Lane. Stormwater detention will be handled by a large stormwater detention pond on the west side of the site that was platted with a previous plat in a common area lot shown as Lot #23. Several rain gardens have been placed

around the site to provide water quality improvements before stormwater reaches the main pond. The main pond will also be planted with a rain garden mixture to provide additional water quality improvements.

Environmental: There are several karst features scattered around the property and the petitioner has placed all of the karst features in this phase within a conservation easement. The PUD required 12.2 acres of preservation on the overall parcel which is being met with this petition and the previous plat for Phase 1. The karst features on this site are located on common area lots and within a conservancy easement. Signage identifying the conservation easement is required along the back sides of the units adjacent to the conservation areas and must be installed per UDO requirements. Signs are required no more than 200 feet apart and shall be a maximum of 1.5 square feet.

Right-of-Way: With this project Adams Street is required to have a total of 75' of right-of-way dedicated and all improvements constructed. This has been shown on the plat. This parcel will be accessed by a new public street connection to Adams Street to the east and the public streets in Summit Ridge to the south. All of the internal streets proposed with this development would be public with 50' of dedicated right-of-way. All internal streets will have a 5' wide concrete sidewalk and 5' tree plot. This is consistent with the standards of the UDO and other approved developments featuring alley loaded units.

Common Area: There are two common area lots proposed with this plat. These common area lots are for protection of environmental features and were required to be in common area with the final plan approval. A facilities maintenance plan for the entire development was approved with the plat of Phase 1.

CONCLUSION: The development plan associated with this subdivision request offers a highly needed housing type for the community, in an appropriate location. The lack of sensitive environmental features allows for a dense, infill project with a high degree of connectivity, while still allowing for preservation of the karst features on the site. The proposed secondary plat is consistent with the approved primary plat and final plan and meets the UDO requirements.

RECOMMENDATION: The Planning and Transportation Department recommends that the Plan Commission approve the secondary plat, DP-35-21, with the following conditions:

1. A grading permit is required for any of the improvements shown within this plat. No further land disturbing activities are allowed until a grading permit is approved.

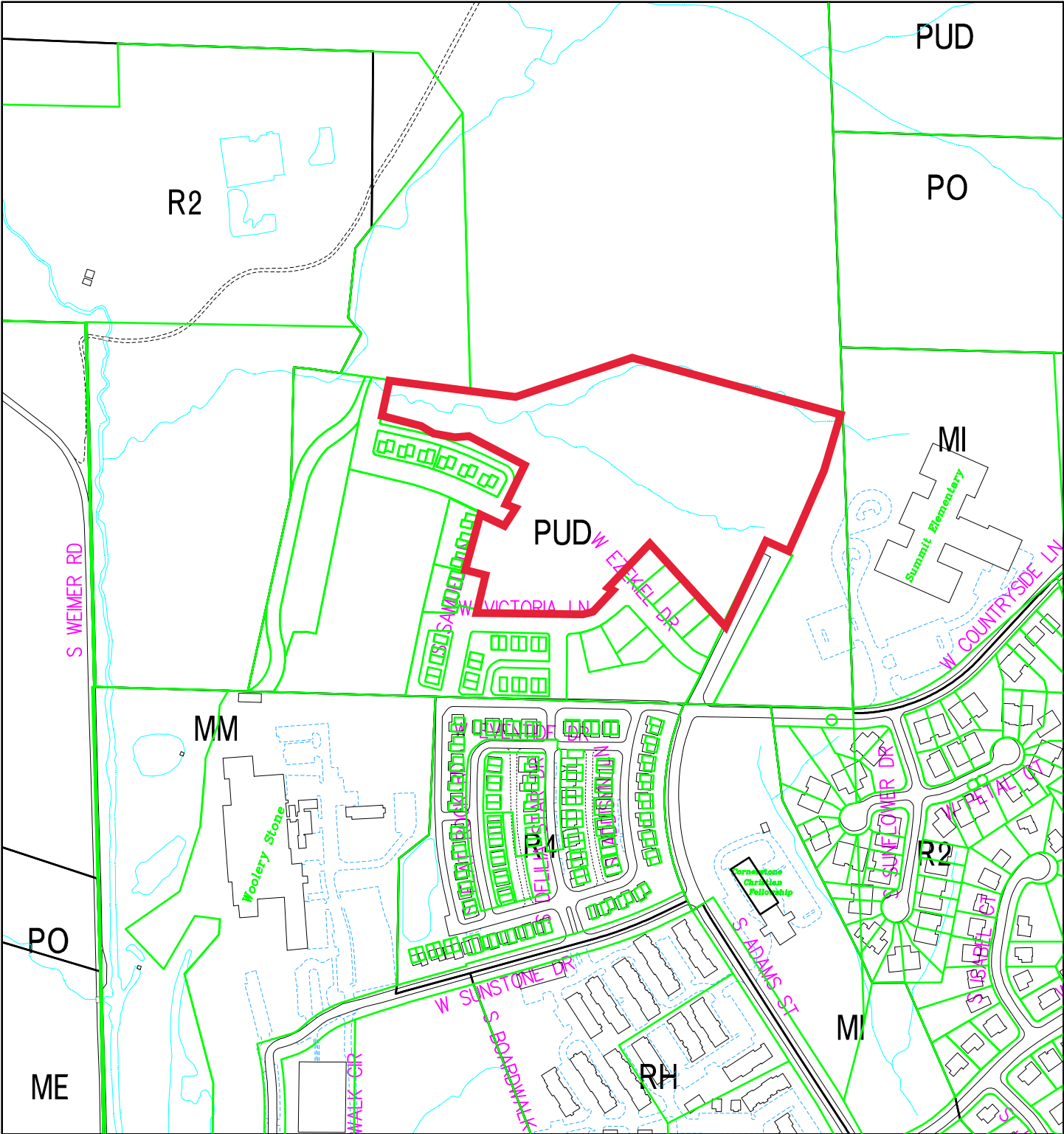

City of Bloomington
Planning

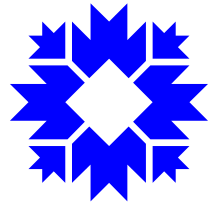

Scale: 1" = 400'

By: greulice
9 Dec 21

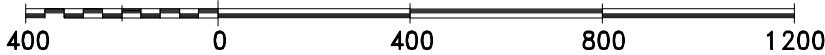

For reference only; map information NOT warranted.

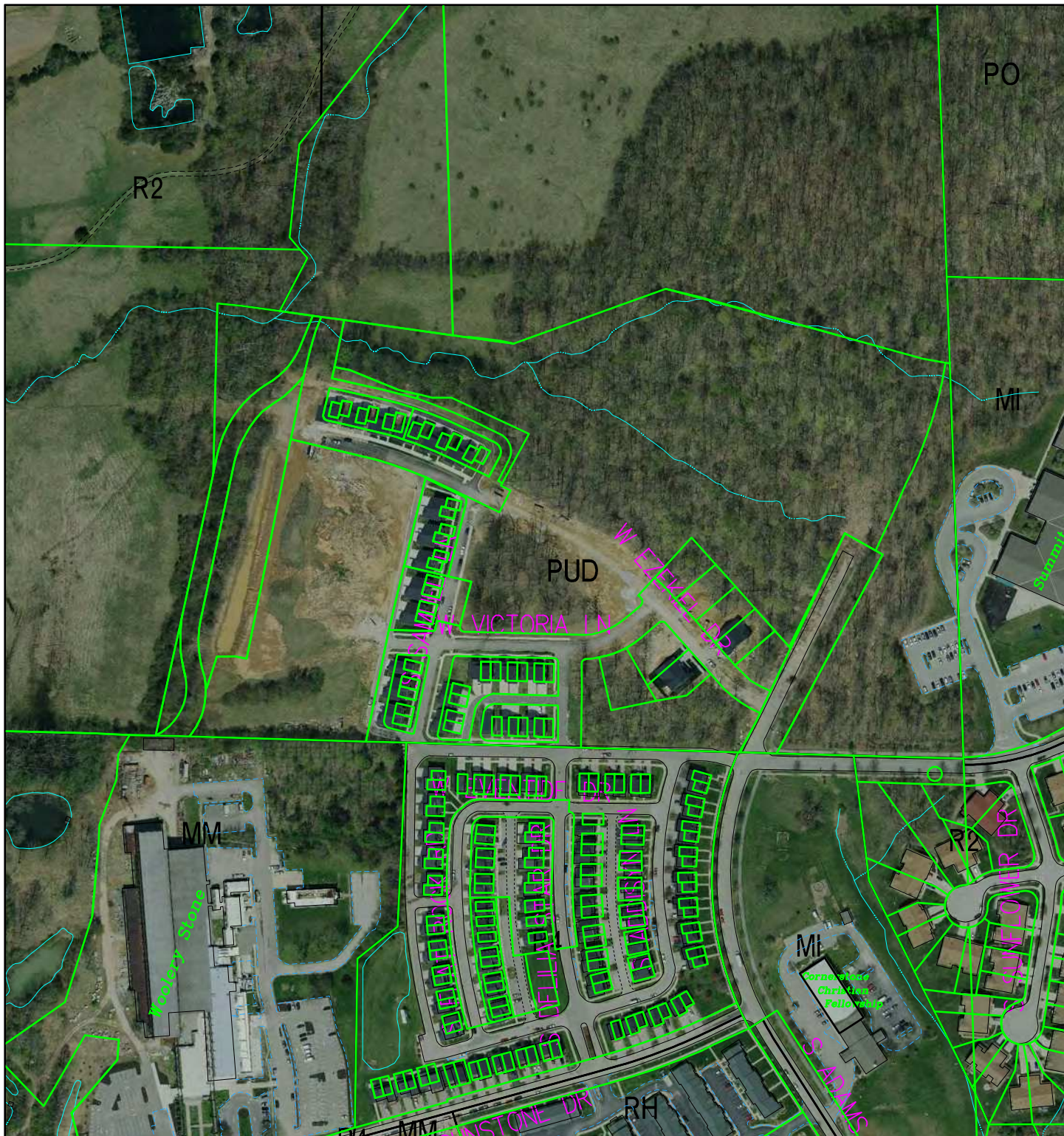

City of Bloomington
Planning

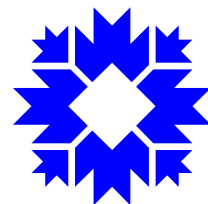

Scale: 1" = 300'

By: greulice
9 Dec 21

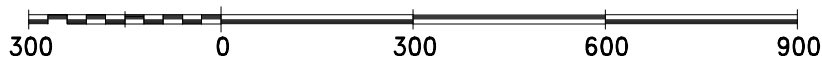

For reference only; map information NOT warranted.



Todd M. Borgman, PS
 Katherine E. Stein, PE
 Donald J. Kocarek, LA
 Stephen L. Smith, Founder

“Professional design and survey since 1979”

Petitioner’s Statement Summit Woods Phase 2 Primary Plat

Location

The site is located on the Sudbury Farm PUD, specifically on the parcel designated as “O”. This parcel lies at the north end of parcel “O” and will conclude its development.

Size

Phase 2 includes 9 detached single family residential lots, 3 Blocks for the attached single family residential units (18 units), and 2 common area lots.

Common Area Lot 18

This common area lot is comprised of tree preservation easements and karst conservancy easements. The lot will also serve as a community park and playground.

Common Area Lot 20

This common area lot is comprised of conservancy easement and kart conservancy easements.

Access

Access is provided by the dedication of new public roadways and alleys. The right-of-way width of public roadways is 50’. The right-of-way width of public alleys is 20’.

Lot Standards

Lot standards for the development are as approved by the PUD and Plan Commission.

Detached Single Family

Minimum Lots size = 6,600 Sf (0.15 AC)

Minimum Lot Width = 60’ at BSL

Minimum Lot Depth = 110’

Front Yard Setback (build to line) = 15’

Rear Yard Setback = 25’

Side Yard Setback = 5’, regardless of number of stories

Garage Setback = 20’ from build to line for front load garage

No additional setback for side load garage

Unit type – 1 story ranch, ranch over basement, 2 story

Finished floor must be a minimum of 2’ above street grade

Attached Single Family Area

Limited common area outside unit footprint

Front yard Setback (build to line) = 10’

Side yard setback adjacent to alley = 10’

Minimum distance between units = 15’

2 parking spaces per unit, minimum

Unit type – 2 story over basement garage, 2 story

Parking - Internal garage, driveway and or surface parking

Parking / Garage Area Access derived from a public alley



LEGEND
EASEMENT
EASEMENT LINE
UTILITY POLE
SCALE 1"=20'

LEGAL DESCRIPTION
A CERTAIN PART OF SECTION 7, TOWNSHIP 8 NORTH, RANGE 1 WEST, MONROE COUNTY, INDIANA...

SURVEYOR'S CERTIFICATE
I, the undersigned, being duly sworn, depose and say that I am a duly Licensed Professional Surveyor...

PLANNING AND TRANSPORTATION
UNDER THE APPLICABLE INDIANA CODE AND THE TERMS SPECIFIED IN THE GENERAL...

OWNER
I, the undersigned, being duly sworn, depose and say that I am the owner of the...

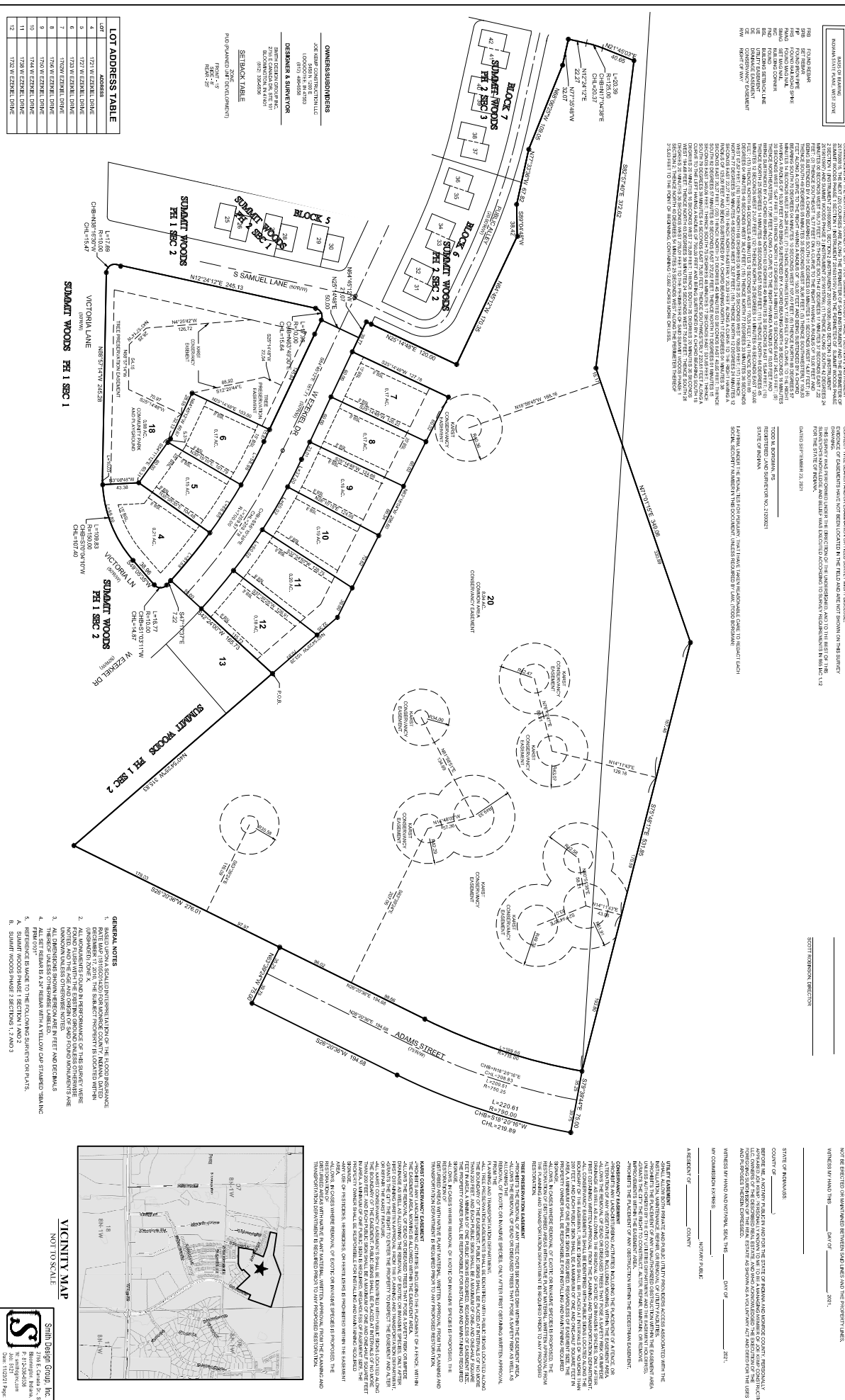

LOT ADDRESS TABLE
LOT NO. ADDRESS
1 1721 W. EZZELINE DRIVE

OWNERS/SUBDIVISORS
DORIS M. BROWN, TRUSTEE
DORIS M. BROWN, TRUSTEE

DEVELOPER & SURVEYOR
SOUTH CENTRAL SURVEYING, INC.
18721 W. EZZELINE DRIVE
INDIANAPOLIS, IN 46240

SETBACK TABLE
FRONT: 5'
SIDE: 5'
REAR: 5'

GENERAL NOTES
1. BASED UPON A SOLIDIFIED REPRESENTATION OF THE RECORD INSTRUMENT...



SMITH DESIGN GROUP, INC.
2105 E. CANAL ST., SU. 101
INDIANAPOLIS, IN 46202

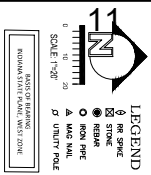

LEGEND

SCALE 1"=20'
DATE: 12/21/2011
PROJECT: SUMMIT WOODS PHASE 2

LEGAL DESCRIPTION
SECTION 7, TOWNSHIP 8 NORTH, RANGE 1 WEST, MONROE COUNTY, INDIANA
SUBDIVISION: SUMMIT WOODS PHASE 2

SUMMIT WOODS PHASE 2 SECTION 4 FINAL PLAT

SOUTHEAST QUARTER OF SECTION 7, TOWNSHIP 8 NORTH, RANGE 1 WEST, MONROE COUNTY, INDIANA
PERRY TOWNSHIP, MONROE COUNTY, INDIANA

SURVEYOR'S CERTIFICATE

I, the undersigned, being duly qualified and sworn as a Surveyor in and for the State of Indiana, do hereby certify that the foregoing is a true and correct copy of the original plat as recorded in my office.

Surveyor Name: [Name]
Address: [Address]

Notary Public Name: [Name]
Address: [Address]

Table with 2 columns: LOT ADDRESS TABLE. Lists lot numbers and corresponding addresses.

OWNERS/SUBDIVISOR: [Name]
DEVELOPER & SURVEYOR: [Name]

SETBACK TABLE

Table with 2 columns: FRONT, SIDE, REAR setbacks in feet.

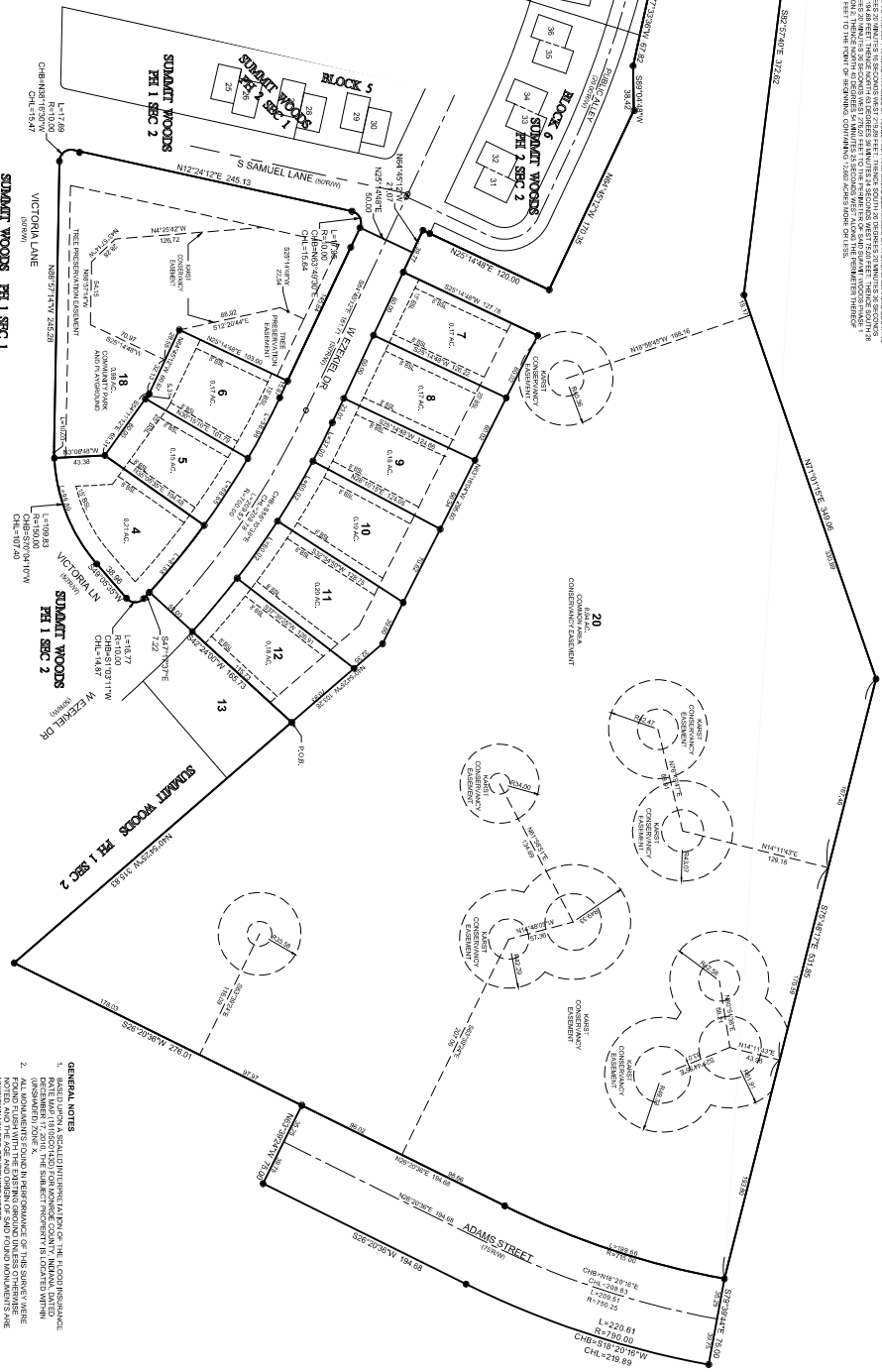

- GENERAL NOTES
1. BASED UPON A SOLID SURVEILLATION OF THE RECORD INSTRUMENT...
2. ALL MONUMENTS FOUND IN PERFORMANCE OF THIS SURVEY WERE FOUND TO BE IN PLACE AND CORRECTLY LOCATED WITHIN THE BOUNDARIES OF THE LOTS AND ARE THEREFORE SHOWN AS SUCH UNLESS OTHERWISE SPECIFIED.

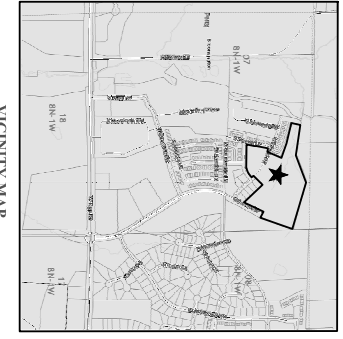

Smith Design Group, Inc.
2105 E. Canada St., Ste. 100
P.O. Box 1000
Mooresville, NC 28117
www.smithdesigngroup.com
Date: 12/21/2011 Page: 11

PLANNING AND TRANSPORTATION
UNDER THE APPOINTMENT AUTHORITY OF THE BOARD OF SUPERVISORS OF THE COUNTY OF MONROE, INDIANA, I HEREBY CERTIFY THAT THE FOLLOWING IS A TRUE AND CORRECT COPY OF THE ORIGINAL PLAT AS RECORDED IN MY OFFICE.

OWNER
The undersigned, being duly qualified and sworn as a Surveyor in and for the State of Indiana, do hereby certify that the foregoing is a true and correct copy of the original plat as recorded in my office.

RECORD OF MONROE COUNTY
SECTION 7, TOWNSHIP 8 NORTH, RANGE 1 WEST, MONROE COUNTY, INDIANA
SUBDIVISION: SUMMIT WOODS PHASE 2

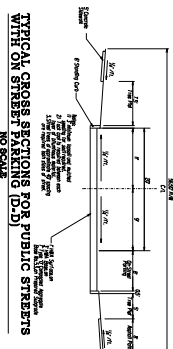
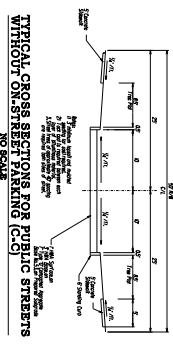
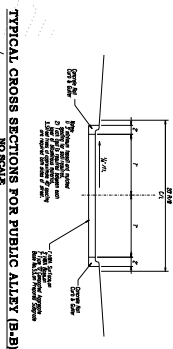
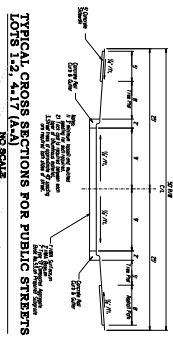
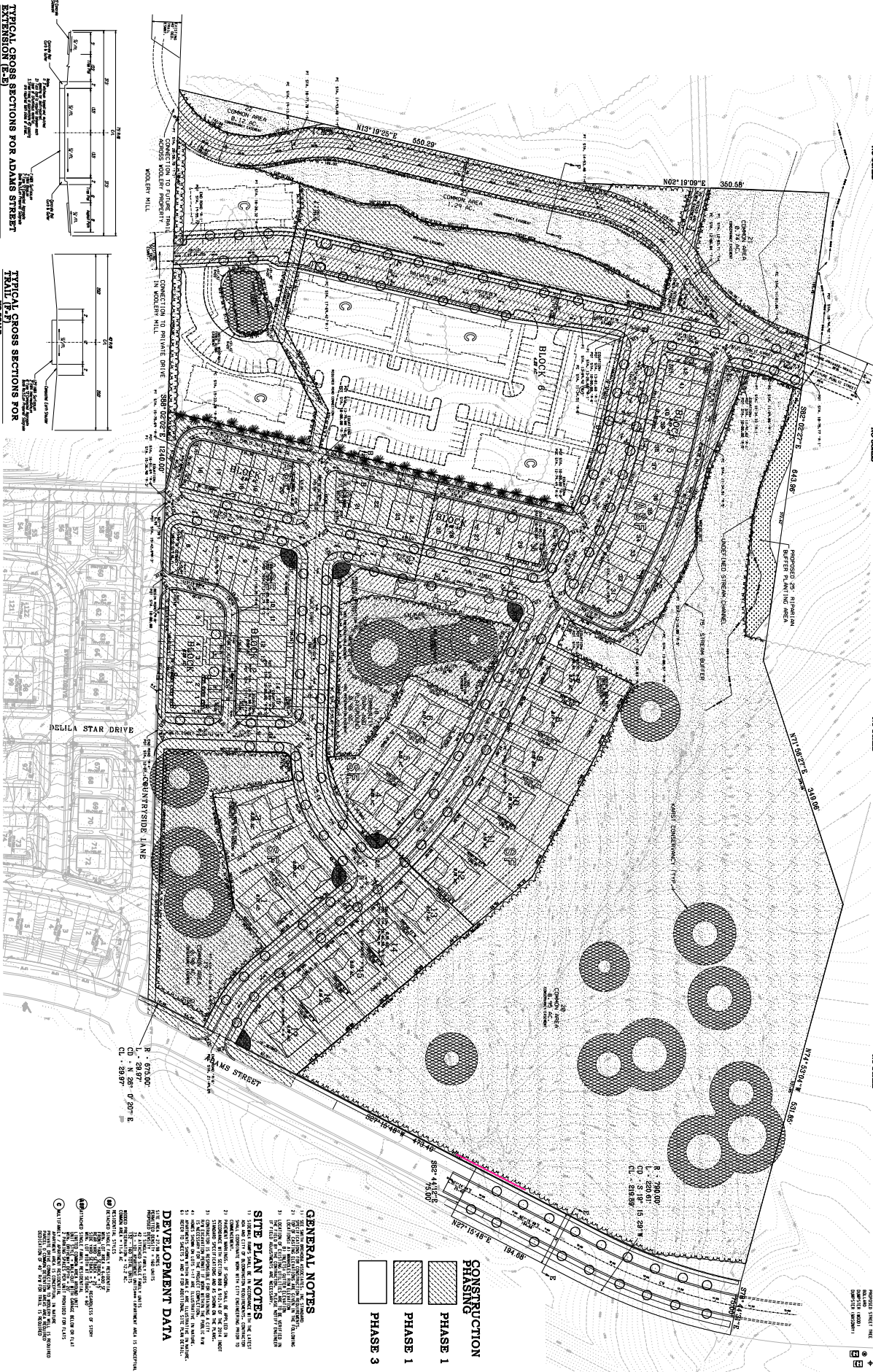

SITE LEGEND

1"	1:12"
2"	1:24"
3"	1:36"
4"	1:48"
5"	2:00"
6"	2:16"
7"	2:32"
8"	2:48"
9"	3:04"
10"	3:20"
11"	3:36"
12"	3:52"
13"	4:08"
14"	4:24"
15"	4:40"
16"	4:56"
17"	5:12"
18"	5:28"
19"	5:44"
20"	6:00"
21"	6:16"
22"	6:32"
23"	6:48"
24"	7:04"
25"	7:20"
26"	7:36"
27"	7:52"
28"	8:08"
29"	8:24"
30"	8:40"
31"	8:56"
32"	9:12"
33"	9:28"
34"	9:44"
35"	10:00"
36"	10:16"
37"	10:32"
38"	10:48"
39"	11:04"
40"	11:20"
41"	11:36"
42"	11:52"
43"	12:08"
44"	12:24"
45"	12:40"
46"	12:56"
47"	13:12"
48"	13:28"
49"	13:44"
50"	14:00"

GENERAL NOTES

- 1) SEE THE SCHEDULE FOR THE EXACT DIMENSIONS OF THE LOTS AND COMMON AREAS.
- 2) THE DISTANCES SHOWN ARE THE DISTANCES BETWEEN THE CENTER LINES OF THE STREETS AND THE CENTER LINES OF THE LOTS.
- 3) THE DISTANCES SHOWN ARE THE DISTANCES BETWEEN THE CENTER LINES OF THE STREETS AND THE CENTER LINES OF THE LOTS.
- 4) THE DISTANCES SHOWN ARE THE DISTANCES BETWEEN THE CENTER LINES OF THE STREETS AND THE CENTER LINES OF THE LOTS.
- 5) THE DISTANCES SHOWN ARE THE DISTANCES BETWEEN THE CENTER LINES OF THE STREETS AND THE CENTER LINES OF THE LOTS.
- 6) THE DISTANCES SHOWN ARE THE DISTANCES BETWEEN THE CENTER LINES OF THE STREETS AND THE CENTER LINES OF THE LOTS.
- 7) THE DISTANCES SHOWN ARE THE DISTANCES BETWEEN THE CENTER LINES OF THE STREETS AND THE CENTER LINES OF THE LOTS.
- 8) THE DISTANCES SHOWN ARE THE DISTANCES BETWEEN THE CENTER LINES OF THE STREETS AND THE CENTER LINES OF THE LOTS.
- 9) THE DISTANCES SHOWN ARE THE DISTANCES BETWEEN THE CENTER LINES OF THE STREETS AND THE CENTER LINES OF THE LOTS.
- 10) THE DISTANCES SHOWN ARE THE DISTANCES BETWEEN THE CENTER LINES OF THE STREETS AND THE CENTER LINES OF THE LOTS.
- 11) THE DISTANCES SHOWN ARE THE DISTANCES BETWEEN THE CENTER LINES OF THE STREETS AND THE CENTER LINES OF THE LOTS.
- 12) THE DISTANCES SHOWN ARE THE DISTANCES BETWEEN THE CENTER LINES OF THE STREETS AND THE CENTER LINES OF THE LOTS.
- 13) THE DISTANCES SHOWN ARE THE DISTANCES BETWEEN THE CENTER LINES OF THE STREETS AND THE CENTER LINES OF THE LOTS.
- 14) THE DISTANCES SHOWN ARE THE DISTANCES BETWEEN THE CENTER LINES OF THE STREETS AND THE CENTER LINES OF THE LOTS.
- 15) THE DISTANCES SHOWN ARE THE DISTANCES BETWEEN THE CENTER LINES OF THE STREETS AND THE CENTER LINES OF THE LOTS.
- 16) THE DISTANCES SHOWN ARE THE DISTANCES BETWEEN THE CENTER LINES OF THE STREETS AND THE CENTER LINES OF THE LOTS.
- 17) THE DISTANCES SHOWN ARE THE DISTANCES BETWEEN THE CENTER LINES OF THE STREETS AND THE CENTER LINES OF THE LOTS.
- 18) THE DISTANCES SHOWN ARE THE DISTANCES BETWEEN THE CENTER LINES OF THE STREETS AND THE CENTER LINES OF THE LOTS.
- 19) THE DISTANCES SHOWN ARE THE DISTANCES BETWEEN THE CENTER LINES OF THE STREETS AND THE CENTER LINES OF THE LOTS.
- 20) THE DISTANCES SHOWN ARE THE DISTANCES BETWEEN THE CENTER LINES OF THE STREETS AND THE CENTER LINES OF THE LOTS.

CONSTRUCTION PHASING

1"	1:12"
2"	1:24"
3"	1:36"
4"	1:48"
5"	2:00"
6"	2:16"
7"	2:32"
8"	2:48"
9"	3:04"
10"	3:20"
11"	3:36"
12"	3:52"
13"	4:08"
14"	4:24"
15"	4:40"
16"	4:56"
17"	5:12"
18"	5:28"
19"	5:44"
20"	6:00"
21"	6:16"
22"	6:32"
23"	6:48"
24"	7:04"
25"	7:20"
26"	7:36"
27"	7:52"
28"	8:08"
29"	8:24"
30"	8:40"
31"	8:56"
32"	9:12"
33"	9:28"
34"	9:44"
35"	10:00"
36"	10:16"
37"	10:32"
38"	10:48"
39"	11:04"
40"	11:20"
41"	11:36"
42"	11:52"
43"	12:08"
44"	12:24"
45"	12:40"
46"	12:56"
47"	13:12"
48"	13:28"
49"	13:44"
50"	14:00"

DEVELOPMENT DATA

1"	1:12"
2"	1:24"
3"	1:36"
4"	1:48"
5"	2:00"
6"	2:16"
7"	2:32"
8"	2:48"
9"	3:04"
10"	3:20"
11"	3:36"
12"	3:52"
13"	4:08"
14"	4:24"
15"	4:40"
16"	4:56"
17"	5:12"
18"	5:28"
19"	5:44"
20"	6:00"
21"	6:16"
22"	6:32"
23"	6:48"
24"	7:04"
25"	7:20"
26"	7:36"
27"	7:52"
28"	8:08"
29"	8:24"
30"	8:40"
31"	8:56"
32"	9:12"
33"	9:28"
34"	9:44"
35"	10:00"
36"	10:16"
37"	10:32"
38"	10:48"
39"	11:04"
40"	11:20"
41"	11:36"
42"	11:52"
43"	12:08"
44"	12:24"
45"	12:40"
46"	12:56"
47"	13:12"
48"	13:28"
49"	13:44"
50"	14:00"

REVISIONS

NO.	BY	DATE

OVERALL SITE PLAN

2 of 25

07/15/15

5/21

ADAMS STREET

DECELLA STAR DRIVE

ADAMS STREET

JOB TITLE

SUDBURY PARCEL O
PUD FINAL PLAN

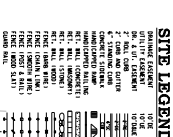

Smith Drebek & Associates, Inc.
409 S. Chicker Boulevard
Ann Arbor, Michigan, 48106
Phone: (734) 964-4400
Fax: (734) 964-4413
Web: www.smithdrebek.com



**BLOOMINGTON PLAN COMMISSION
STAFF REPORT
Location: 2700 W. Tapp Road**

**CASE #: DP-39-21
DATE: December 13, 2021**

PETITIONER: Public Investment Corporation
2417 Fields South Drive, Champaign, IL

CONSULTANT: Smith Brehob & Associates, Inc.
453 S. Clarizz Blvd, Bloomington

REQUEST: The petitioner is requesting secondary plat approval to allow an 8 lot commercial subdivision.

BACKGROUND:

Area: 29.76 acres
Current Zoning: Mixed-Use Employment (ME)
Comp Plan Designation: Employment
Existing Land Use: Undeveloped
Proposed Land Use: Commercial/Industrial
Surrounding Uses: North – Undeveloped property
East – Commercial (Woolery)
South – Business/Professional Offices/Undeveloped
West – Commercial/Industrial

REPORT: The property is located at 2700 W. Tapp Road and was within the Mill Creek Planned Unit Development (PUD-40-87). This former PUD was rezoned to Mixed-Use Employment (ME) with the 2021 Zoning Map Update. Surrounding properties to the north and west are also within the Mill Creek development, to the south is the Southern Indiana Medical Park, and to the east is the Woolery Mill Development. The properties to the west of this site have been developed with a commercial office park. A final plan approval and preliminary plat approval were given under Plan Commission case #PUD-27-17 to allow for the installation of roads and infrastructure and overall layout of lots. A secondary plat was approved in 2020 (DP-02-20) to allow for a 9 lot subdivision for Phase 2 Section 1 of this development. A grading permit has also been issued to allow for the installation of infrastructure, general site grading, and improvements for Phase 2 Section 1 of the development.

The petitioner is requesting secondary plat approval for Phase 2 Section 2 of the development in order to plat 6 commercial lots and 2 common area lots. The proposed plat follows the approved primary plat and final plan approval. The common area lots were required to be set aside to protect environmental features and for tree preservation requirements. The proposed Common Area lot #30 is proposed to be dedicated to the Parks Foundation for inclusion with the adjacent Wapehani Park. All of the internal roads will be public and the required amount of right-of-way has been shown that is consistent with the approved preliminary plat and approved cross sections.

SECONDARY PLAT REVIEW:

Lot Layout: This plat will create 6 commercial lots and 2 common area lots. All of the proposed lots meet the minimum lot width and lot area standards of the PUD that was in place when the preliminary plat and final plan were approved, as well as the Mixed-Use Employment (ME) zoning district. A portion of Common Area Lot #29 was identified as being a location for stormwater detention for this section. A second detention area was provided on Section 1 to the south for the development as well.

Right-of-Way: Within the overall development, Weimer Road will be relocated west to run through the center of this property as shown on the Transportation Plan. This section of road has been named “Vanguard Parkway”. Weimer Rd. is classified as a Primary Collector and a total of 65’ of right-of-way is required. However, in order to minimize disturbance through this property, the Plan Commission approved a specific cross-section of this road for these phases with only 60’ of right-of-way being dedicated. At the final plan stage, the Department worked with the petitioner on an appropriate cross section for the new Weimer Road to include bike lanes as well as sidewalks and tree plots. The approved cross sections have been shown on the secondary plat. A temporary turn-around-easement has been shown on the northern most portion of the right-of-way until the stub street is extended. Future sections of Weimer to the north of the overall development are required to dedicate the full right-of-way shown in the transportation plan. All internal streets will be public with a total of 50’ of right-of-way dedicated for each.

Street Trees: New street trees are required no less than 20’ and not more than 40’ from center along all internal public streets. A site plan showing the number and location of proposed street trees must be submitted prior to bonding and signature of secondary plat.

Common Area: There are two common area lots shown on the secondary plat. The UDO requires that areas of tree preservation over one acre in size be set aside in common area and this met through the preservation of features on the common area lots. The common area lots contain areas of 18% slope that are required to be preserved. A facilities maintenance plan has been submitted and will be recorded with the secondary plat.

Environmental: The petitioner is meeting the tree preservation requirements with the approved site plan and some of the required tree preservation area is being set aside on the common area lots shown with this phase. There is one karst feature on the site that is required to be set aside in karst preservation easement and has been shown as well. The site also has several areas of 18% slope and those have been set aside within the common area as well.

SECONDARY PLAT REVIEW: The Plan Commission shall review the secondary plat petition and approve, approve with conditions, or deny the petition in accordance with Section 20.06.040(g) (Review and Decision), based on the general approval criteria in Section 20.06.040(d)(6)(B) (General Compliance Criteria).

20.06.040(d)(6)(B) General Compliance Criteria

- i. Compliance with this UDO
- ii. Compliance with Other Applicable Regulations
- iii. Compliance with Utility, Service, and Improvement Standards
- iv. Compliance with Prior Approvals

PROPOSED FINDING: The petition meets all of the requirements and standards of the UDO and the approved final plan and preliminary plat. There are no other known applicable regulations related to the plat. No problems have been identified with meeting all stormwater and utility connections. This phase of this development is consistent with what was approved with the final plan and primary plat. A third phase will be forthcoming to plat the remaining lots.

CONCLUSION: This secondary plat follows the approved preliminary plat and approved final plan. The proposed plat meets all of the UDO subdivision regulations.

RECOMMENDATION: The Department recommends the Plan Commission adopt the proposed findings and approve DP-39-21 with the following conditions of approval:

1. A facilities maintenance plan must be recorded with this plat.
2. A site plan showing the number and location of proposed street trees must be submitted prior to bonding and signature of secondary plat.
3. The locations of signage associated with the environmental easements must be shown on the grading plan.



City of Bloomington
Bloomington Environmental Commission

MEMORANDUM

Date: December 13, 2021
To: Bloomington Plan Commission
From: Bloomington Environmental Commission
Subject: DP-39-21: Public Investment Corporation
2700 W. Tapp Road

The purpose of this memo and all Environmental Commission (EC) memos involving the Plan Commission and new development in Bloomington, is to convey the environmental concerns and subsequent recommendations for conditions of approval. The Environmental Commission's objective is that the results of our review and suggestions will lead to enhancement of the ecosystem services provided, and the climate-change mitigation attributes of the site.

Comments

1.) Signage is required around the perimeter of easements per UDO 20.05.04, Easements. To make the number and locations clear from the beginning, the EC recommends that the location of all signs be shown on the Plat.

Recommended Conditions of Approval

1.) Show the locations of signage associated with the easements.

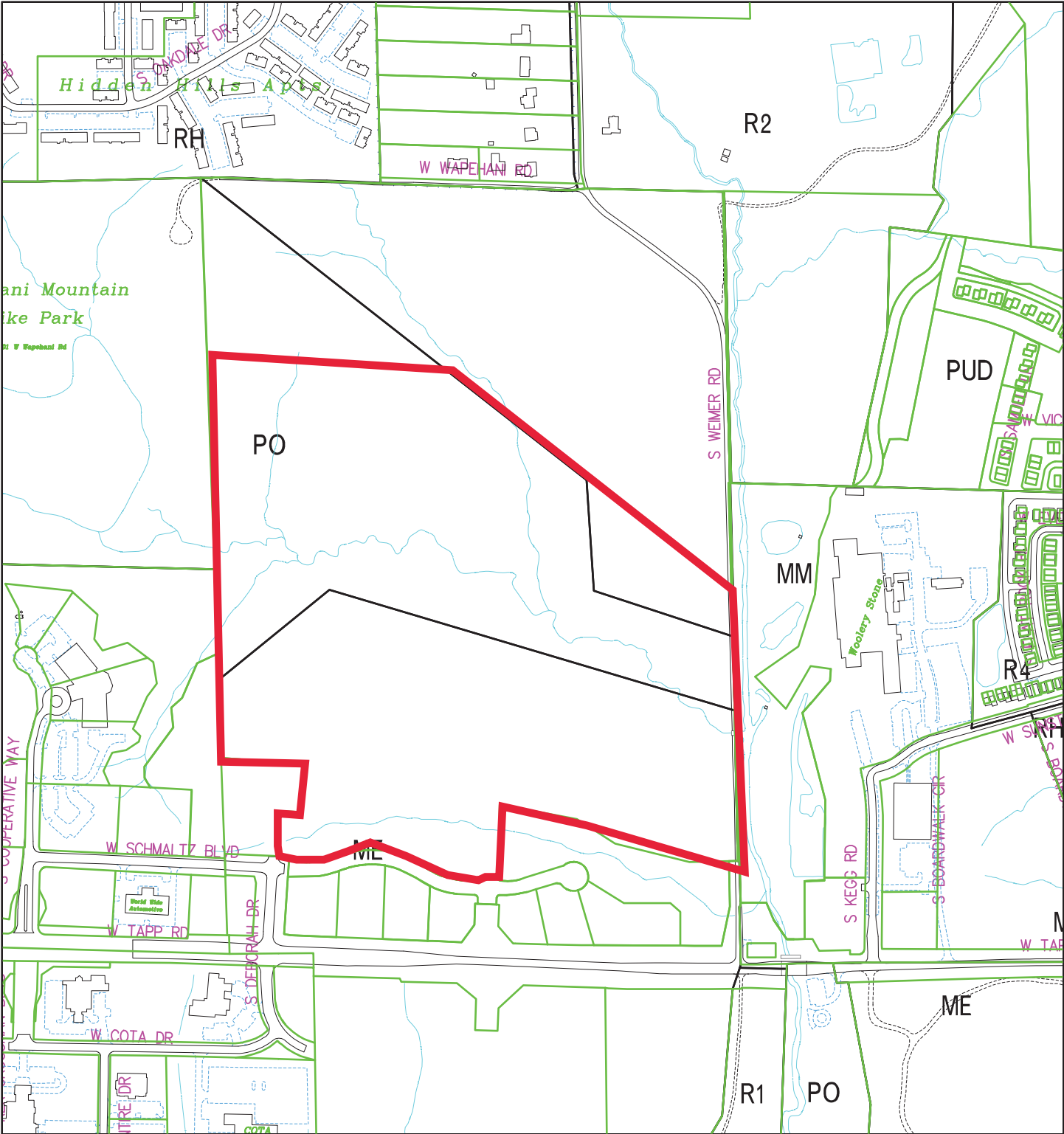

City of Bloomington
Planning

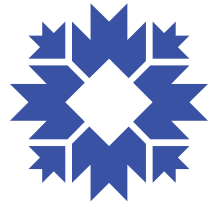

Scale: 1" = 500'

By: greulice
10 Dec 21

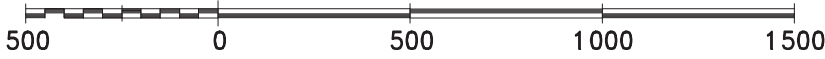

For reference only; map information NOT warranted.

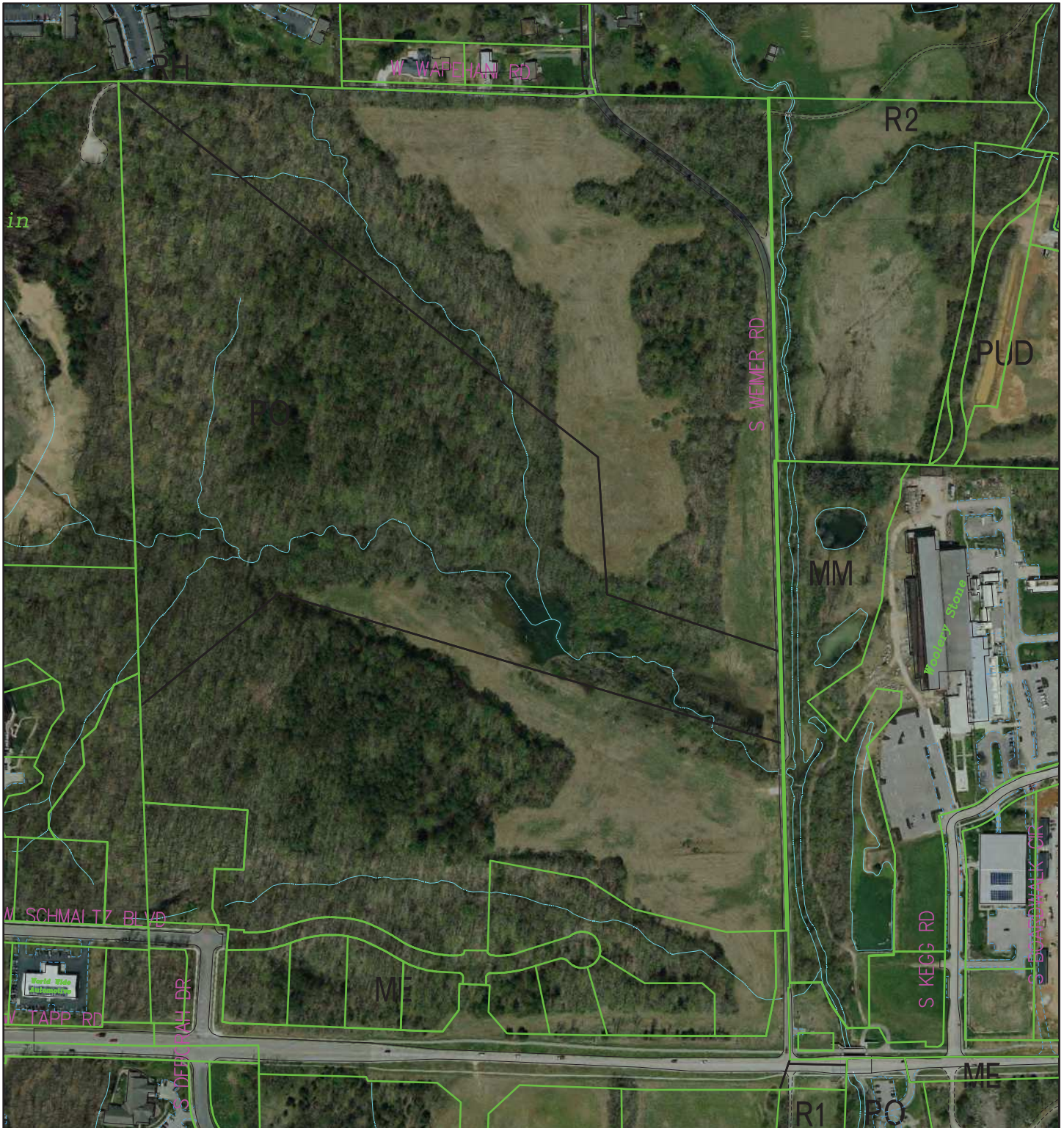

City of Bloomington
Planning

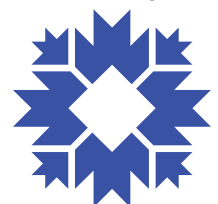

Scale: 1" = 400'

By: greulice
10 Dec 21



For reference only; map information NOT warranted.



Todd M. Borgman, PS
Katherine E. Stein, PE
Donald J. Kocarek, LA
Stephen L. Smith, Founder

“Professional design and survey since 1979”

Petitioner’s Statement Mill Creek Phase 2 Section 2

Purpose

The purpose of this final plat is to create Phase 2 Section 2 of Mill Creek.

Location

The subject property is located at the northwest corner of W Tapp Road and S Weimer Road.

Parcels

This plat will create 6 lots for commercial development and 1 common areas and conservation easement lot (Lot 29) and 1 lot to be dedicated to City of Bloomington Parks Department (Lot 30).

R/W Dedication

Right-of-way dedication is in accordance with the approval of the preliminary plat from 2018

Pedestrian Easement

Pedestrian easement is being created across common area lots 29 for access to Lot 30, which will be dedicated to the Parks Department. These easements will encompass new pathways.

Conservancy Easements

Conservancy easements are being created to restrict any land-disturbing activities within selected areas.

Karst Conservancy Easements

Karst conservancy easements is being created to restrict any land-disturbing activities with the selected areas on Lot 29.

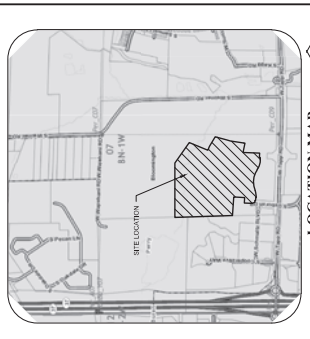
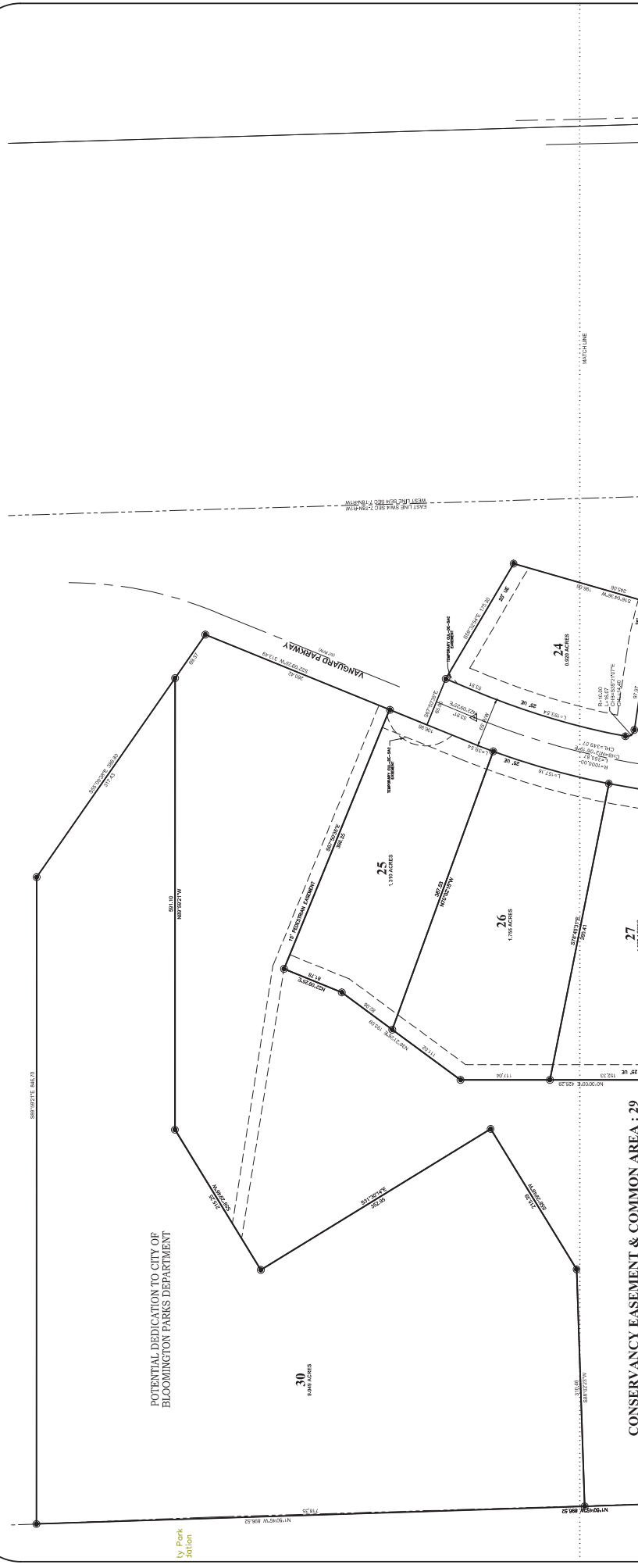

21
 MILL CREEK PHASE 2 SECTION 2 FINAL PLAT
 SMITH DESIGN GROUP, INC. 2755 E. CANADA DR., STE 101 | BLOOMINGTON, INDIANA 47401
 T. 812.338.6536 | www.smithdgc.com
 PLAT DATED: OCTOBER 28, 2021

SCALE: 1"=60'
 BASIS OF BEARINGS:
 INDIANA STATE PLANE
 WEST ZONE

- GENERAL NOTES**
1. ALL NEW CORNERS ARE TO BE MARKED WITH A 5/8" X 2" WITH YELLOW SIA CAPPED REBAR OR MARKERS.
 2. THE LOCATION OF ALL EASEMENTS AND THE EXISTENCE OF A CURRENT TITLE COMMITMENT, EVIDENCE OF EASEMENTS HAVE NOT BEEN LOCATED IN THE FIELD AND ARE BEING SHOWN AS AN ASSUMPTION.
 3. REFERENCE IS MADE TO THE FOLLOWING SURVEYS OR PLATS:
 PLAT 17, 18, 19, 20, 21, 22, 23, 24, 25, 26, 27, 28, 29, 30, 31, 32, 33, 34, 35, 36, 37, 38, 39, 40, 41, 42, 43, 44, 45, 46, 47, 48, 49, 50, 51, 52, 53, 54, 55, 56, 57, 58, 59, 60, 61, 62, 63, 64, 65, 66, 67, 68, 69, 70, 71, 72, 73, 74, 75, 76, 77, 78, 79, 80, 81, 82, 83, 84, 85, 86, 87, 88, 89, 90, 91, 92, 93, 94, 95, 96, 97, 98, 99, 100, 101, 102, 103, 104, 105, 106, 107, 108, 109, 110, 111, 112, 113, 114, 115, 116, 117, 118, 119, 120, 121, 122, 123, 124, 125, 126, 127, 128, 129, 130, 131, 132, 133, 134, 135, 136, 137, 138, 139, 140, 141, 142, 143, 144, 145, 146, 147, 148, 149, 150, 151, 152, 153, 154, 155, 156, 157, 158, 159, 160, 161, 162, 163, 164, 165, 166, 167, 168, 169, 170, 171, 172, 173, 174, 175, 176, 177, 178, 179, 180, 181, 182, 183, 184, 185, 186, 187, 188, 189, 190, 191, 192, 193, 194, 195, 196, 197, 198, 199, 200, 201, 202, 203, 204, 205, 206, 207, 208, 209, 210, 211, 212, 213, 214, 215, 216, 217, 218, 219, 220, 221, 222, 223, 224, 225, 226, 227, 228, 229, 230, 231, 232, 233, 234, 235, 236, 237, 238, 239, 240, 241, 242, 243, 244, 245, 246, 247, 248, 249, 250, 251, 252, 253, 254, 255, 256, 257, 258, 259, 260, 261, 262, 263, 264, 265, 266, 267, 268, 269, 270, 271, 272, 273, 274, 275, 276, 277, 278, 279, 280, 281, 282, 283, 284, 285, 286, 287, 288, 289, 290, 291, 292, 293, 294, 295, 296, 297, 298, 299, 300, 301, 302, 303, 304, 305, 306, 307, 308, 309, 310, 311, 312, 313, 314, 315, 316, 317, 318, 319, 320, 321, 322, 323, 324, 325, 326, 327, 328, 329, 330, 331, 332, 333, 334, 335, 336, 337, 338, 339, 340, 341, 342, 343, 344, 345, 346, 347, 348, 349, 350, 351, 352, 353, 354, 355, 356, 357, 358, 359, 360, 361, 362, 363, 364, 365, 366, 367, 368, 369, 370, 371, 372, 373, 374, 375, 376, 377, 378, 379, 380, 381, 382, 383, 384, 385, 386, 387, 388, 389, 390, 391, 392, 393, 394, 395, 396, 397, 398, 399, 400, 401, 402, 403, 404, 405, 406, 407, 408, 409, 410, 411, 412, 413, 414, 415, 416, 417, 418, 419, 420, 421, 422, 423, 424, 425, 426, 427, 428, 429, 430, 431, 432, 433, 434, 435, 436, 437, 438, 439, 440, 441, 442, 443, 444, 445, 446, 447, 448, 449, 450, 451, 452, 453, 454, 455, 456, 457, 458, 459, 460, 461, 462, 463, 464, 465, 466, 467, 468, 469, 470, 471, 472, 473, 474, 475, 476, 477, 478, 479, 480, 481, 482, 483, 484, 485, 486, 487, 488, 489, 490, 491, 492, 493, 494, 495, 496, 497, 498, 499, 500, 501, 502, 503, 504, 505, 506, 507, 508, 509, 510, 511, 512, 513, 514, 515, 516, 517, 518, 519, 520, 521, 522, 523, 524, 525, 526, 527, 528, 529, 530, 531, 532, 533, 534, 535, 536, 537, 538, 539, 540, 541, 542, 543, 544, 545, 546, 547, 548, 549, 550, 551, 552, 553, 554, 555, 556, 557, 558, 559, 560, 561, 562, 563, 564, 565, 566, 567, 568, 569, 570, 571, 572, 573, 574, 575, 576, 577, 578, 579, 580, 581, 582, 583, 584, 585, 586, 587, 588, 589, 590, 591, 592, 593, 594, 595, 596, 597, 598, 599, 600, 601, 602, 603, 604, 605, 606, 607, 608, 609, 610, 611, 612, 613, 614, 615, 616, 617, 618, 619, 620, 621, 622, 623, 624, 625, 626, 627, 628, 629, 630, 631, 632, 633, 634, 635, 636, 637, 638, 639, 640, 641, 642, 643, 644, 645, 646, 647, 648, 649, 650, 651, 652, 653, 654, 655, 656, 657, 658, 659, 660, 661, 662, 663, 664, 665, 666, 667, 668, 669, 670, 671, 672, 673, 674, 675, 676, 677, 678, 679, 680, 681, 682, 683, 684, 685, 686, 687, 688, 689, 690, 691, 692, 693, 694, 695, 696, 697, 698, 699, 700, 701, 702, 703, 704, 705, 706, 707, 708, 709, 710, 711, 712, 713, 714, 715, 716, 717, 718, 719, 720, 721, 722, 723, 724, 725, 726, 727, 728, 729, 730, 731, 732, 733, 734, 735, 736, 737, 738, 739, 740, 741, 742, 743, 744, 745, 746, 747, 748, 749, 750, 751, 752, 753, 754, 755, 756, 757, 758, 759, 760, 761, 762, 763, 764, 765, 766, 767, 768, 769, 770, 771, 772, 773, 774, 775, 776, 777, 778, 779, 780, 781, 782, 783, 784, 785, 786, 787, 788, 789, 790, 791, 792, 793, 794, 795, 796, 797, 798, 799, 800, 801, 802, 803, 804, 805, 806, 807, 808, 809, 810, 811, 812, 813, 814, 815, 816, 817, 818, 819, 820, 821, 822, 823, 824, 825, 826, 827, 828, 829, 830, 831, 832, 833, 834, 835, 836, 837, 838, 839, 840, 841, 842, 843, 844, 845, 846, 847, 848, 849, 850, 851, 852, 853, 854, 855, 856, 857, 858, 859, 860, 861, 862, 863, 864, 865, 866, 867, 868, 869, 870, 871, 872, 873, 874, 875, 876, 877, 878, 879, 880, 881, 882, 883, 884, 885, 886, 887, 888, 889, 890, 891, 892, 893, 894, 895, 896, 897, 898, 899, 900, 901, 902, 903, 904, 905, 906, 907, 908, 909, 910, 911, 912, 913, 914, 915, 916, 917, 918, 919, 920, 921, 922, 923, 924, 925, 926, 927, 928, 929, 930, 931, 932, 933, 934, 935, 936, 937, 938, 939, 940, 941, 942, 943, 944, 945, 946, 947, 948, 949, 950, 951, 952, 953, 954, 955, 956, 957, 958, 959, 960, 961, 962, 963, 964, 965, 966, 967, 968, 969, 970, 971, 972, 973, 974, 975, 976, 977, 978, 979, 980, 981, 982, 983, 984, 985, 986, 987, 988, 989, 990, 991, 992, 993, 994, 995, 996, 997, 998, 999, 1000.
 5. ALL REAL ESTATE IS SUBJECT TO THE FACILITIES MAINTENANCE PLAN INSTRUMENT # 202011620.

LOT ADDRESS TABLE

LOT	ADDRESS
23	77
24	77
25	77
26	77
27	77
28	77

SETBACKS
 FLOODZONE X
 SITE IS LOCATED IN FLOODZONE X.
 FRONT YARD - 35 FEET
 REAR YARD - 10 FEET
 ANY REVISION DATED DEC. 17, 2010

ALL LOTS ARE ZONED MIXED-USE EMPLOYMENT (ME)

LEGEND

8	GROUP	M	MARKED
9	STAKE	P	PLATTED
10	STAKE	R	RECORDED
11	STAKE	S	SETBACK
12	STAKE	T	TOTAL
13	STAKE	U	UTILITY
14	STAKE	V	VALUATION
15	STAKE	W	WATER
16	STAKE	X	EXHIBIT
17	STAKE	Y	YIELD
18	STAKE	Z	ZONING
19	STAKE	AA	ADJACENT
20	STAKE	AB	ADJACENT
21	STAKE	AC	ADJACENT
22	STAKE	AD	ADJACENT
23	STAKE	AE	ADJACENT
24	STAKE	AF	ADJACENT
25	STAKE	AG	ADJACENT
26	STAKE	AH	ADJACENT
27	STAKE	AI	ADJACENT
28	STAKE	AJ	ADJACENT
29	STAKE	AK	ADJACENT
30	STAKE	AL	ADJACENT
31	STAKE	AM	ADJACENT
32	STAKE	AN	ADJACENT
33	STAKE	AO	ADJACENT
34	STAKE	AP	ADJACENT
35	STAKE	AQ	ADJACENT
36	STAKE	AR	ADJACENT
37	STAKE	AS	ADJACENT
38	STAKE	AT	ADJACENT
39	STAKE	AU	ADJACENT
40	STAKE	AV	ADJACENT
41	STAKE	AW	ADJACENT
42	STAKE	AX	ADJACENT
43	STAKE	AY	ADJACENT
44	STAKE	AZ	ADJACENT
45	STAKE	BA	ADJACENT
46	STAKE	BB	ADJACENT
47	STAKE	BC	ADJACENT
48	STAKE	BD	ADJACENT
49	STAKE	BE	ADJACENT
50	STAKE	BF	ADJACENT
51	STAKE	BG	ADJACENT
52	STAKE	BH	ADJACENT
53	STAKE	BI	ADJACENT
54	STAKE	BJ	ADJACENT
55	STAKE	BK	ADJACENT
56	STAKE	BL	ADJACENT
57	STAKE	BM	ADJACENT
58	STAKE	BN	ADJACENT
59	STAKE	BO	ADJACENT
60	STAKE	BP	ADJACENT
61	STAKE	BQ	ADJACENT
62	STAKE	BR	ADJACENT
63	STAKE	BS	ADJACENT
64	STAKE	BT	ADJACENT
65	STAKE	BU	ADJACENT
66	STAKE	BV	ADJACENT
67	STAKE	BW	ADJACENT
68	STAKE	BX	ADJACENT
69	STAKE	BY	ADJACENT
70	STAKE	BZ	ADJACENT
71	STAKE	CA	ADJACENT
72	STAKE	CB	ADJACENT
73	STAKE	CC	ADJACENT
74	STAKE	CD	ADJACENT
75	STAKE	CE	ADJACENT
76	STAKE	CF	ADJACENT
77	STAKE	CG	ADJACENT
78	STAKE	CH	ADJACENT
79	STAKE	CI	ADJACENT
80	STAKE	CJ	ADJACENT
81	STAKE	CK	ADJACENT
82	STAKE	CL	ADJACENT
83	STAKE	CM	ADJACENT
84	STAKE	CN	ADJACENT
85	STAKE	CO	ADJACENT
86	STAKE	CP	ADJACENT
87	STAKE	CQ	ADJACENT
88	STAKE	CR	ADJACENT
89	STAKE	CS	ADJACENT
90	STAKE	CT	ADJACENT
91	STAKE	CU	ADJACENT
92	STAKE	CV	ADJACENT
93	STAKE	CW	ADJACENT
94	STAKE	CX	ADJACENT
95	STAKE	CY	ADJACENT
96	STAKE	CZ	ADJACENT
97	STAKE	DA	ADJACENT
98	STAKE	DB	ADJACENT
99	STAKE	DC	ADJACENT
100	STAKE	DD	ADJACENT

POTENTIAL DEDICATION TO CITY OF BLOOMINGTON PARKS DEPARTMENT

CONSERVANCY EASEMENT & COMMON AREA : 29

PERRY TOWNSHIP
 SECTION 7
 TOWNSHIP 8 NORTH
 RANGE 1 WEST
 OWNER OF RECORD
 PUBLIC INVESTMENT CORPORATION
 DEED BOOK 1327 PAGE 440

SETBACKS
 FLOODZONE X
 SITE IS LOCATED IN FLOODZONE X.
 FRONT YARD - 35 FEET
 REAR YARD - 10 FEET
 ANY REVISION DATED DEC. 17, 2010

LEGEND

8	GROUP	M	MARKED
9	STAKE	P	PLATTED
10	STAKE	R	RECORDED
11	STAKE	S	SETBACK
12	STAKE	T	TOTAL
13	STAKE	U	UTILITY
14	STAKE	V	VALUATION
15	STAKE	W	WATER
16	STAKE	X	EXHIBIT
17	STAKE	Y	YIELD
18	STAKE	Z	ZONING
19	STAKE	AA	ADJACENT
20	STAKE	AB	ADJACENT
21	STAKE	AC	ADJACENT
22	STAKE	AD	ADJACENT
23	STAKE	AE	ADJACENT
24	STAKE	AF	ADJACENT
25	STAKE	AG	ADJACENT
26	STAKE	AH	ADJACENT
27	STAKE	AI	ADJACENT
28	STAKE	AJ	ADJACENT
29	STAKE	AK	ADJACENT
30	STAKE	AL	ADJACENT
31	STAKE	AM	ADJACENT
32	STAKE	AN	ADJACENT
33	STAKE	AO	ADJACENT
34	STAKE	AP	ADJACENT
35	STAKE	AQ	ADJACENT
36	STAKE	AR	ADJACENT
37	STAKE	AS	ADJACENT
38	STAKE	AT	ADJACENT
39	STAKE	AU	ADJACENT
40	STAKE	AV	ADJACENT
41	STAKE	AW	ADJACENT
42	STAKE	AX	ADJACENT
43	STAKE	AY	ADJACENT
44	STAKE	AZ	ADJACENT
45	STAKE	BA	ADJACENT
46	STAKE	BB	ADJACENT
47	STAKE	BC	ADJACENT
48	STAKE	BD	ADJACENT
49	STAKE	BE	ADJACENT
50	STAKE	BF	ADJACENT
51	STAKE	BG	ADJACENT
52	STAKE	BH	ADJACENT
53	STAKE	BI	ADJACENT
54	STAKE	BJ	ADJACENT
55	STAKE	BK	ADJACENT
56	STAKE	BL	ADJACENT
57	STAKE	BM	ADJACENT
58	STAKE	BN	ADJACENT
59	STAKE	BO	ADJACENT
60	STAKE	BP	ADJACENT
61	STAKE	BQ	ADJACENT
62	STAKE	BR	ADJACENT
63	STAKE	BS	ADJACENT
64	STAKE	BT	ADJACENT
65	STAKE	BU	ADJACENT
66	STAKE	BV	ADJACENT
67	STAKE	BW	ADJACENT
68	STAKE	BX	ADJACENT
69	STAKE	BY</	



FACILITIES PLAN

FOR

MILL CREEK

Phase 2

Prepared by:
Smith Brehob & Associates, Inc.
453 S. Clarizz Boulevard
Bloomington, IN. 47401

FACILITIES PLAN

Mill Creek

Table of Contents

Maintenance Responsibility	3
Common Area Facilities	3
Common and Conservancy Areas.....	3
Lawn and Landscape Maintenance	3
Storm Water Facilities.....	3
Storm Water Detention	3
Basin Maintenance.....	4
Storm Sewer Inlet	4
Changes in Management	5
Right-of Entry	5
Technical Questions	5
Appendix A:.....	6
Stormwater Detention Inspection Report.....	6
Exhibits	7

FACILITIES PLAN

Mill Creek

Project Description

The project consists of 54.53 acres of property located at the northwest corner of W Tapp Road and S. Weimer Road. The development will consist of a commercial development as well as conservancy areas. This phase of Mill Creek will be built in sections. This facilities plan includes all sections with Phase 2. Exhibit A shows the location of the site.

Maintenance Responsibility

The Lot Owners Association (LOA) shall be solely responsible for the maintenance of the common and conservancy areas and storm water facilities outside of public right of way within the Mill Creek development as described in this Facilities Plan.

Common Area Facilities

Common and Conservancy Areas

Common and Conservancy areas are located throughout the Mill Creek development as shown in Exhibit B. These areas are wooded and are to be kept as conservancy areas that are not to be disturbed. Within these areas are numerous karst features. It is important the karst features remain in their natural, undisturbed state.

Lawn and Landscape Maintenance

The lawn area shall be mowed on a regular basis during the growing season. Any diseased or dead plants within the landscape area shall be promptly removed and replaced. Leaves shall be collected in a timely manner during the fall to prevent them from being carried downstream and clogging storm sewer inlets. Any litter or refuse shall be removed and disposed of properly.

Storm Water Facilities

Storm Water Detention

Storm water detention facilities are provided in 4 aboveground detention basins. Basin 1 and 2 are located within the south eastern portion of the property. Basin 3 and 4 are located within the northern portion of the property. Exhibit B shows the location of the detention basins. These facilities are located within the common areas of the development and are the responsibility of the LOA.

Basin 1

This above ground basin provides both water quality treatment and water quantity release rate control. The bottom of the basin contains a mix of amended soils and pea gravel with an underdrain and is designed to promote storm water infiltration

FACILITIES PLAN

Mill Creek

and water filtration. The outlet control structure is designed to provide for extended detention times, forcing storm water infiltration and release through an under drain system within the pea gravel layer. The location of the basin is shown on Exhibit B. Details of the outlet control structure and amended soils are shown on Exhibit C.

Basin 2

This above ground basin provides both water quality treatment and water quantity release rate control. The bottom of the basin contains a mix of amended soils and pea gravel with an underdrain and is designed to promote storm water infiltration and water filtration. The outlet control structure is designed to provide for extended detention times, forcing storm water infiltration and release through an under drain system within the pea gravel layer. The location of the basin is shown on Exhibit B. Details of the outlet control structure and amended soils are shown on Exhibit D

Basin 3

This above ground basin provides both water quality treatment and water quantity release rate control. The bottom of the basin contains a mix of amended soils and pea gravel with an underdrain and is designed to promote storm water infiltration and water filtration. The outlet control structure is designed to provide for extended detention times, forcing storm water infiltration and release through an under drain system within the pea gravel layer. The location of the basin is shown on Exhibit B. Details of the outlet control structure and amended soils are shown on Exhibit E

Basin 4

This above ground basin provides both water quality treatment and water quantity release rate control. The bottom of the basin contains a mix of amended soils and pea gravel with an underdrain and is designed to promote storm water infiltration and water filtration. The outlet control structure is designed to provide for extended detention times, forcing storm water infiltration and release through an under drain system within the pea gravel layer. The location of the basin is shown on Exhibit B. Details of the outlet control structure and amended soils are shown on Exhibit F

Basin Maintenance

Maintenance and periodic inspection of the detention basins will be required. The basins should be inspected on a quarterly basis. The basins should be kept clean of trash and debris that could clog the outlet control structure. Accumulated sediment 6 in. depth or more should be promptly removed from the basin and the outlet control structures.

Storm Sewer Inlet

FACILITIES PLAN

Mill Creek

Maintenance and periodic inspection of all common area storm sewer inlets will be required. The inlets should be kept clean of trash and debris that could clog the storm sewer system. Accumulated sediment 6 in. depth or more should be promptly removed from the inlets to prevent the storm sewer system from not operating as designed.

Changes in Management

The operation and maintenance requirements described in this Facilities Plan shall run with the land. The LOA shall be responsible for notifying the City of Bloomington of any change in management or third party property management company. Any change in management or third party property management company shall be documented in the Facilities Plan.

Right-of Entry

The LOA hereby gives the City of Bloomington the right-of-entry over and across the property to inspect the facilities described in this Facilities Plan.

Technical Questions

Any questions regarding the appropriate maintenance or repairs should be directed to Smith Brehob & Associates, Inc. 812-336-6536.

IN WITNESS WHEREOF, the Developer of Mill Creek Technology Park, Phase 2, executes the foregoing Facilities Plan this 30 day of July, 2020.

PUBLIC INVESTMENT CORPORATION

Witness to Theodore J. Ferguson:

Paula Kay England
Printed: Paula Kay England

Theodore J. Ferguson
By: Theodore J. Ferguson, President

Witness to Barbara D. Burris:

Paula Kay England
Printed: Paula Kay England

Barbara D. Burris
Attest: Barbara D. Burris, Secretary

STATE OF INDIANA)
) SS:
COUNTY OF MONROE)

Before me, a Notary Public in and for said County and State, personally appeared Theodore J. Ferguson, President of Public Investment Corporation, who acknowledged the execution of the foregoing Facilities Plan for and on behalf of said Company.

Witness my hand and notarial seal this 30 day of July, 2020.

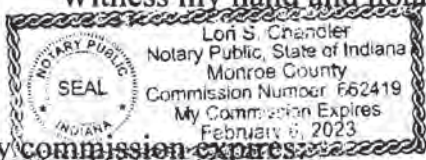
My commission expires: 

Lori S. Chandler
Notary Public
Printed Name: _____
Resident of Monroe County, Indiana

STATE OF INDIANA)
) SS:
COUNTY OF MONROE)

Before me, a Notary Public in and for said County and State, personally appeared Barbara D. Burris, Secretary of Public Investment Corporation, who acknowledged the execution of the foregoing Facilities Plan for and on behalf of said Company.

Witness my hand and notarial seal this 30 day of July, 2020.

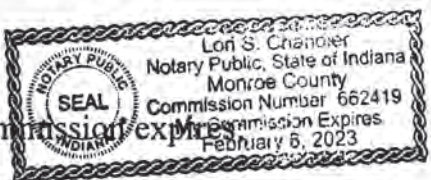
My commission expires: 

Lori S. Chandler
Notary Public
Printed Name: _____
Resident of Monroe County, Indiana

STATE OF INDIANA)
) SS:
COUNTY OF MONROE)

Before me, a Notary Public in and for said County and State, personally appeared Paula Kay England the above named witness to the Facilities Plan, who, being duly sworn by me, did depose and say that he/she knows Theodore J. Ferguson to be the individual described herein and who executed the foregoing Facilities Plan; that said Witness was present and saw said Theodore J. Ferguson execute the same; and that said Witness at the same time subscribed his/her name as a witness thereto.

Witness my hand and Notarial Seal this 30 day of July, 2020.

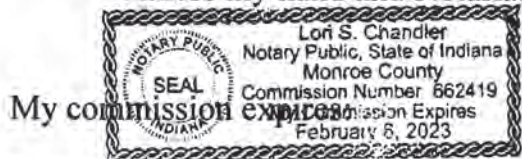

Lori S. Chandler
Printed Name: _____
Resident of Monroe County, Indiana

STATE OF INDIANA)
) SS:
COUNTY OF MONROE)

Before me, a Notary Public in and for said County and State, personally appeared Paula Kay England, the above named witness to the Facilities Plan, who, being duly sworn by me, did depose and say that he/she knows Barbara D. Burris to be the individual described herein and who executed the foregoing Facilities Plan; that said Witness was present and saw said Barbara D. Burris execute the same; and that said Witness at the same time subscribed his/her name as a witness thereto.

Witness my hand and Notarial Seal this 30 day of July, 2020.



Lori S. Chandler
Printed Name: _____
Resident of Monroe County, Indiana

Return to:

Theodore J. Ferguson and Cynthia A. Hamstra
FERGUSON LAW
Attorneys at Law
403 East Sixth Street
Bloomington, IN 47408
Telephone: 812-330-2030

IC 32-2-11-15(d) affirmation:

I affirm under the penalties for perjury, that I have taken reasonable care to redact each social security number in this document, unless required by law.

Signed on July 30, 2020.

By: Seri S. Chandler

FACILITIES PLAN

Mill Creek

Appendix A:
Stormwater Detention Inspection Report

Date of Inspection _____

Company Name _____

Street Address _____

City, State, ZIP _____

Phone _____

Inspector _____

Outlet Control Manhole Structures

Sediment Present Y N

Sediment Removed Y N

Damage Y N

Describe Nature and Repair Required _____

Rip Rap Apron

Erosion Present Y N

Debris Present Y N

Describe Nature and Repair Required _____

Additional comments or actions to be taken

Time Frame

FACILITIES PLAN

Mill Creek

Exhibits

EXHIBIT B



-  = CONSERVATION & COMMON AREA
-  = BASIN

Smith Brehob & Associates, Inc.



453 S. Clarizz Boulevard
 Bloomington, Indiana, 47401
 Telephone: (812) 336-6536
 Fax: (812) 336-0513
 Web: <http://smithbrehob.com>

EXHIBIT C

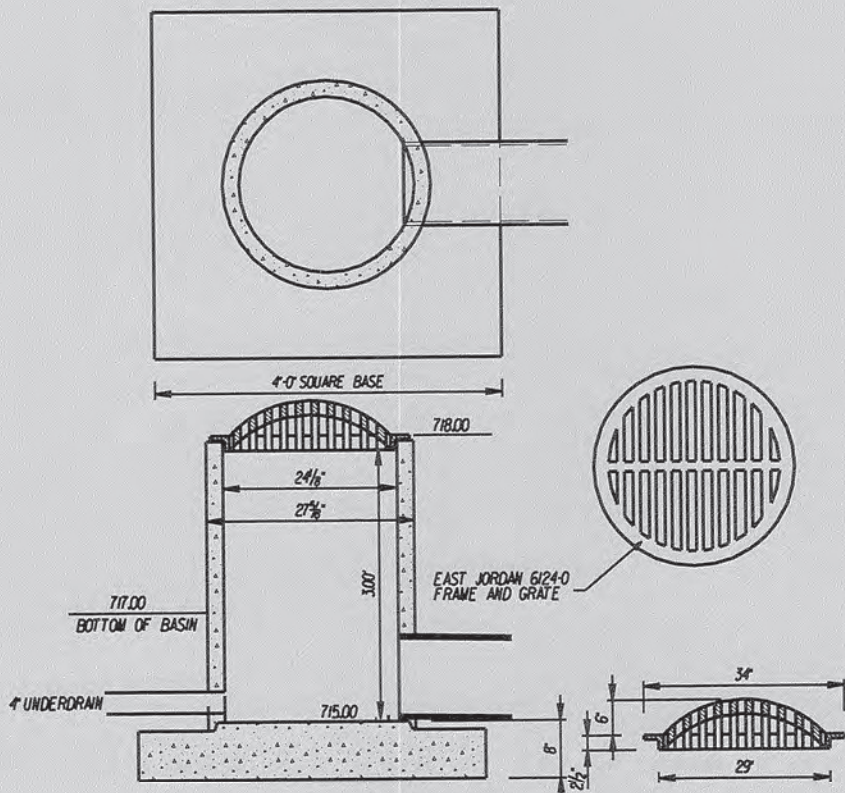

STR 513 DETAIL

NO SCALE

PEA GRAVEL AND AMENDED SOIL TO BE INSTALLED AFTER SITE HAS BEEN STABILIZED TO PREVENT CLOGGING WITH SEDIMENT.

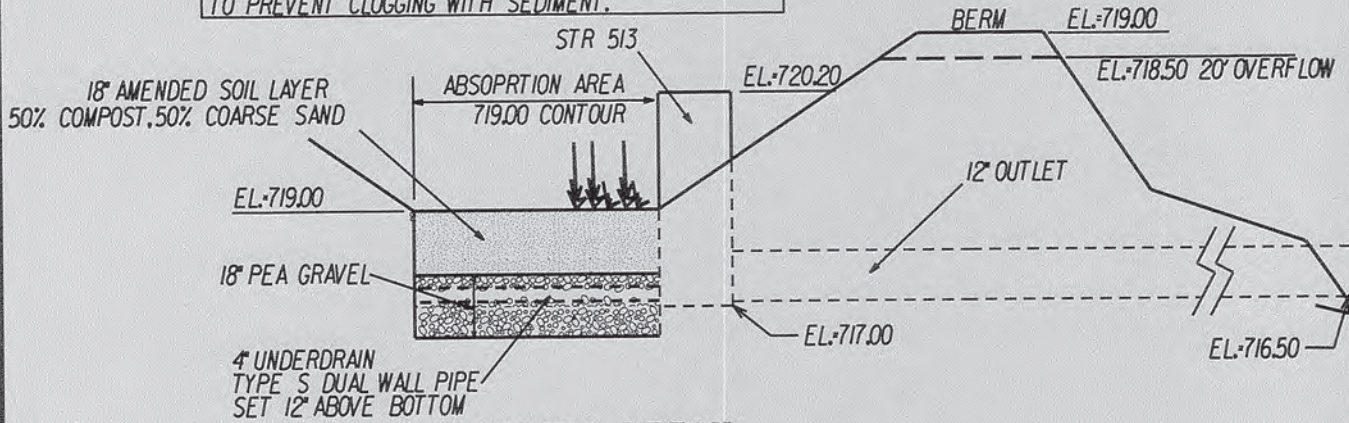

BASIN 1 DETAIL

NO SCALE

Smith Brehob & Associates, Inc.



453 S. Clarizz Boulevard
Bloomington, Indiana, 47401
Telephone: (812) 336-6536
Fax: (812) 336-0513
Web: <http://smithbrehob.com>

EXHIBIT D

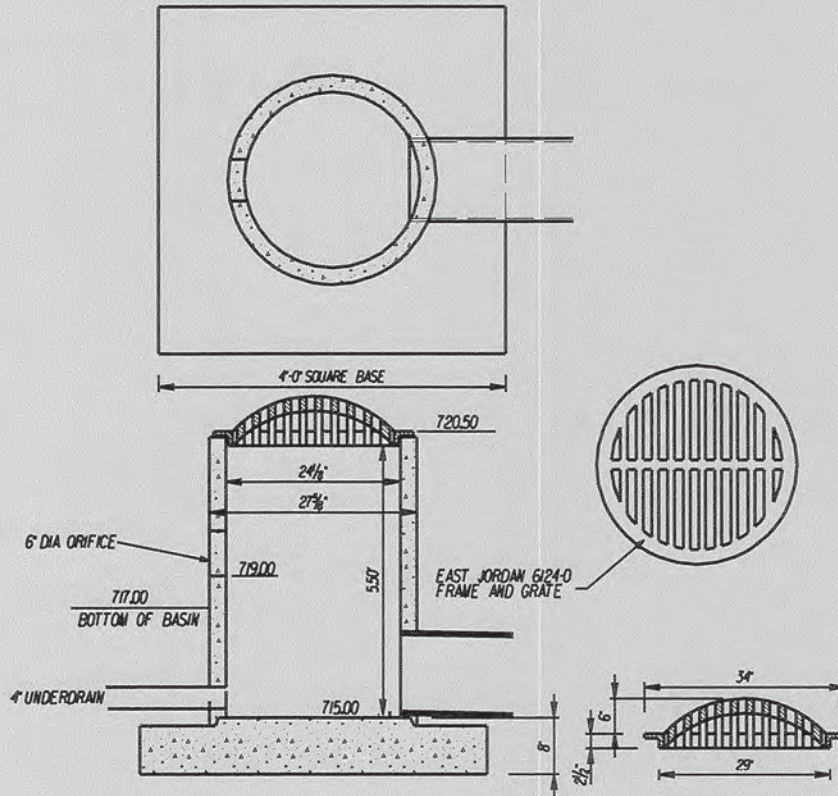

STR 514 DETAIL

NO SCALE

PEA GRAVEL AND AMENDED SOIL TO BE INSTALLED AFTER SITE HAS BEEN STABILIZED TO PREVENT CLOGGING WITH SEDIMENT.

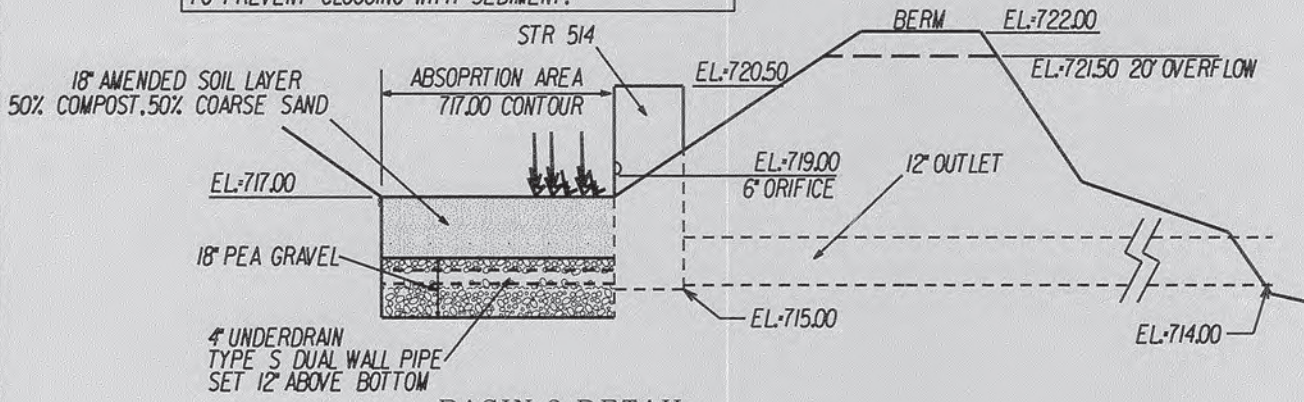

BASIN 2 DETAIL

NO SCALE

Smith Brehob & Associates, Inc.



453 S. Clarizz Boulevard
 Bloomington, Indiana, 47401
 Telephone: (812) 336-6536
 Fax: (812) 336-0513
 Web: <http://smithbrehob.com>

EXHIBIT E

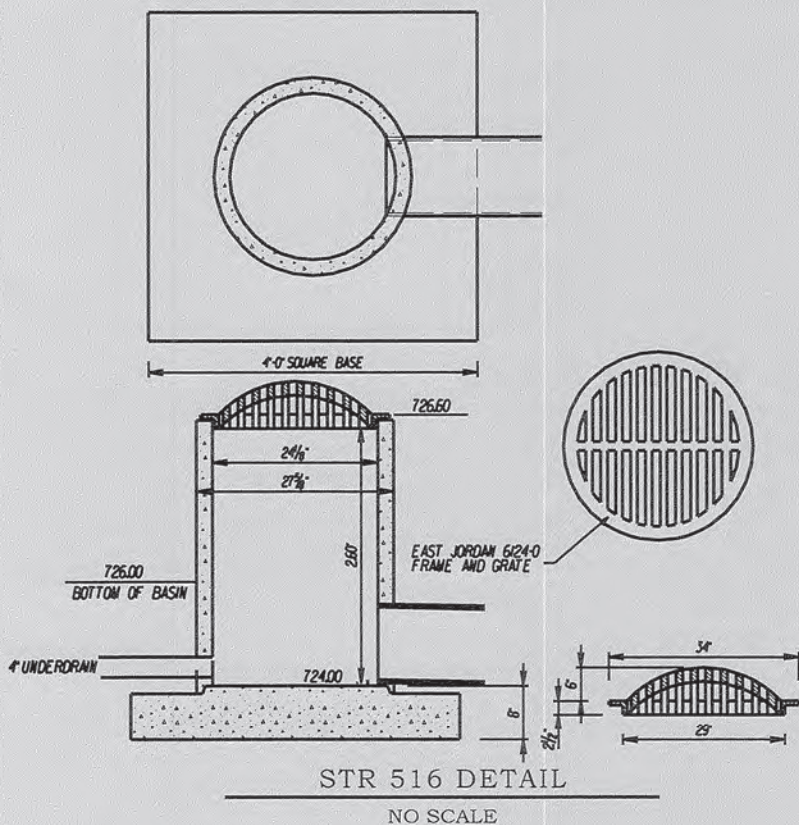

PEA GRAVEL AND AMENDED SOIL
TO BE INSTALLED AFTER SITE HAS BEEN STABILIZED
TO PREVENT CLOGGING WITH SEDIMENT.

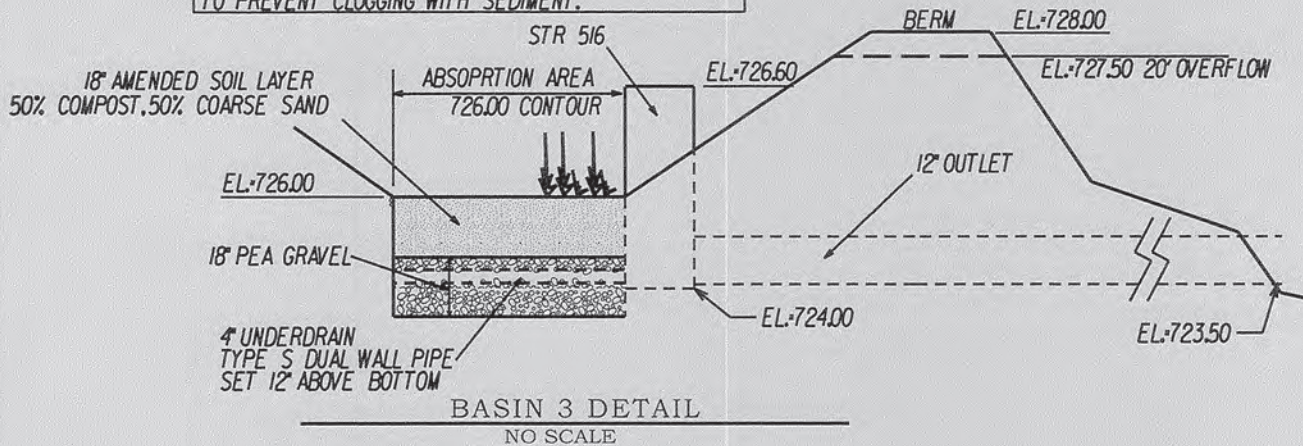

Smith Brehob & Associates, Inc.



453 S. Clarizz Boulevard
Bloomington, Indiana, 47401
Telephone: (812) 336-6536
Fax: (812) 336-0513
Web: <http://smithbrehob.com>

EXHIBIT F

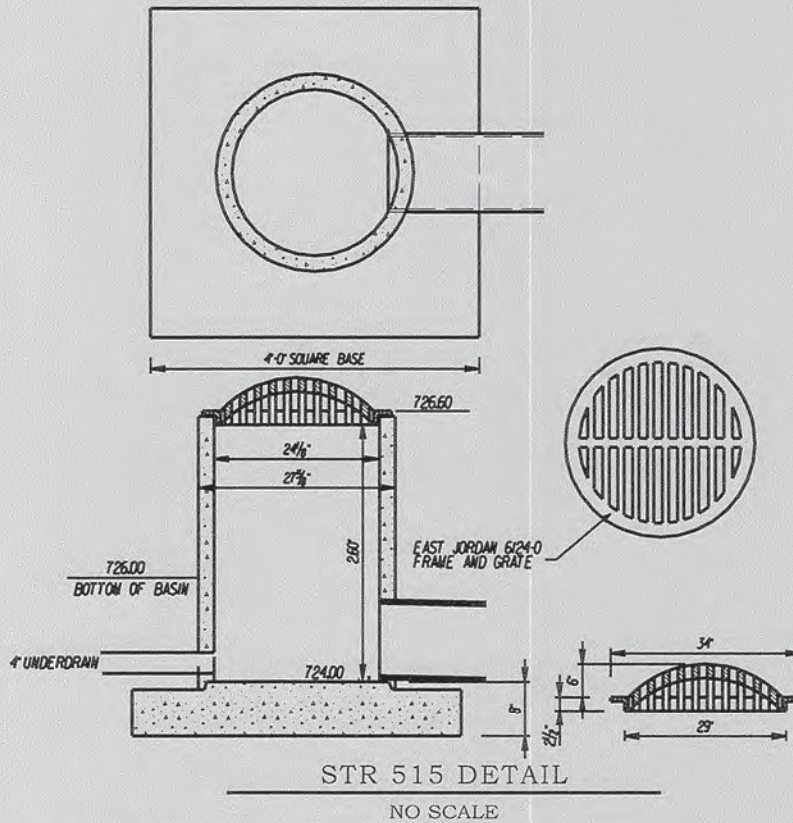

PEA GRAVEL AND AMENDED SOIL TO BE INSTALLED AFTER SITE HAS BEEN STABILIZED TO PREVENT CLOGGING WITH SEDIMENT.

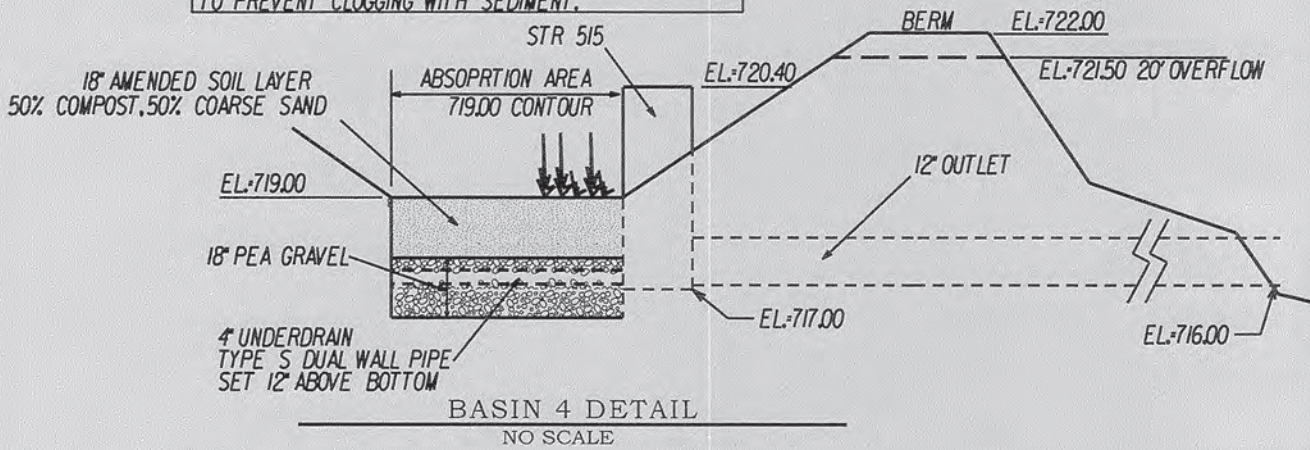

Smith Brehob & Associates, Inc.



453 S. Clarizz Boulevard
 Bloomington, Indiana, 47401
 Telephone: (812) 336-6536
 Fax: (812) 336-0513
 Web: <http://smithbrehob.com>

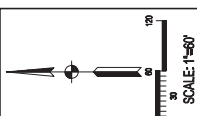

SP
 South Branch & Associates, Inc.
 10000 Highway 101, Suite 100
 Raleigh, North Carolina 27613
 Phone: 919.876.4433
 Fax: 919.876.4433
 www.southbranch.com

**MILL CREEK
 PUD DEVELOPMENT PLAN**

NO.	DATE	BY	REVISIONS

DATE: 05/11/18
 SHEET: 2 of 24
 PROJECT: 5449A
 PRELIMINARY PLAN

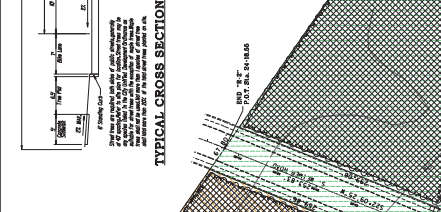
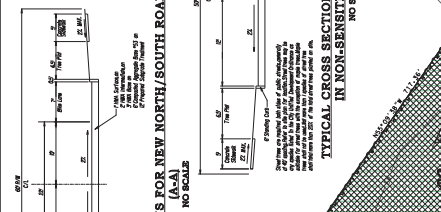
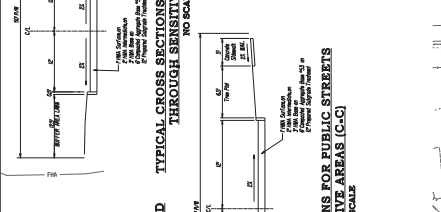
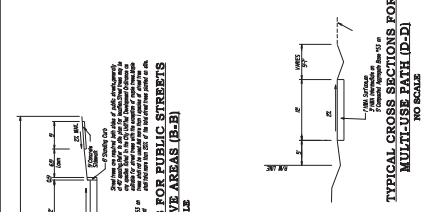

CURVE DATA TABLE

CURVE NO.	RADIUS	LENGTH	DIRECTION	CHORD	CHORD BEARING	LENGTH
1	500.00'	119.50'	N 81° 27' 26" E	118.76'		
2	500.00'	274.31'	S 83° 49' 51" E	264.86'		
3	500.00'	167.40'	S 73° 33' 17" E	165.24'		
4	500.00'	88.76'	N 81° 59' 01" E	88.44'		
5	1000.00'	350.87'	S 12° 06' 19" W	349.07'		
6	500.00'	193.60'	N 71° 40' 38" E	188.97'		

CONSTRUCTION PHASING FOR PHASE 2

SECTION 1
 SECTION 2
 SECTION 3

FINAL PLAT RECORDED WITHIN 30 MONTHS AFTER RECORDING OF SECTION 1 FINAL PLAT
 FINAL PLAT RECORDED WITHIN 30 MONTHS AFTER RECORDING OF SECTION 2 FINAL PLAT
 FINAL PLAT RECORDED WITHIN 30 MONTHS AFTER RECORDING OF SECTION 3 FINAL PLAT
 TREE CANOPY COVERAGE RETAINED

LOT ADDRESS TABLE

LOT NO.	ADDRESS
1	N. SHERBORN DRIVE
2	N. SHERBORN DRIVE
3	N. SHERBORN DRIVE
4	N. SHERBORN DRIVE
5	N. SHERBORN DRIVE
6	N. SHERBORN DRIVE
7	N. SHERBORN DRIVE
8	N. SHERBORN DRIVE
9	N. SHERBORN DRIVE
10	N. SHERBORN DRIVE
11	N. SHERBORN DRIVE
12	N. SHERBORN DRIVE
13	N. SHERBORN DRIVE
14	N. SHERBORN DRIVE
15	N. SHERBORN DRIVE
16	N. SHERBORN DRIVE
17	N. SHERBORN DRIVE
18	N. SHERBORN DRIVE
19	N. SHERBORN DRIVE
20	N. SHERBORN DRIVE
21	N. SHERBORN DRIVE
22	N. SHERBORN DRIVE
23	N. SHERBORN DRIVE
24	N. SHERBORN DRIVE
25	N. SHERBORN DRIVE
26	N. SHERBORN DRIVE
27	N. SHERBORN DRIVE
28	N. SHERBORN DRIVE
29	N. SHERBORN DRIVE
30	N. SHERBORN DRIVE

DEVELOPMENT DATA

SITE AREA = 543.8 ACRES
 TOTAL LOT AREA = 543.8 ACRES
 TOTAL LOT AREA WITHIN PHASE 2 = 543.8 ACRES
 TOTAL LOT AREA WITHIN PHASE 1 = 0.0 ACRES
 TOTAL LOT AREA WITHIN PHASE 3 = 0.0 ACRES
 TOTAL LOT AREA WITHIN PHASE 4 = 0.0 ACRES
 TOTAL LOT AREA WITHIN PHASE 5 = 0.0 ACRES
 TOTAL LOT AREA WITHIN PHASE 6 = 0.0 ACRES
 TOTAL LOT AREA WITHIN PHASE 7 = 0.0 ACRES
 TOTAL LOT AREA WITHIN PHASE 8 = 0.0 ACRES
 TOTAL LOT AREA WITHIN PHASE 9 = 0.0 ACRES
 TOTAL LOT AREA WITHIN PHASE 10 = 0.0 ACRES
 TOTAL LOT AREA WITHIN PHASE 11 = 0.0 ACRES
 TOTAL LOT AREA WITHIN PHASE 12 = 0.0 ACRES
 TOTAL LOT AREA WITHIN PHASE 13 = 0.0 ACRES
 TOTAL LOT AREA WITHIN PHASE 14 = 0.0 ACRES
 TOTAL LOT AREA WITHIN PHASE 15 = 0.0 ACRES
 TOTAL LOT AREA WITHIN PHASE 16 = 0.0 ACRES
 TOTAL LOT AREA WITHIN PHASE 17 = 0.0 ACRES
 TOTAL LOT AREA WITHIN PHASE 18 = 0.0 ACRES
 TOTAL LOT AREA WITHIN PHASE 19 = 0.0 ACRES
 TOTAL LOT AREA WITHIN PHASE 20 = 0.0 ACRES
 TOTAL LOT AREA WITHIN PHASE 21 = 0.0 ACRES
 TOTAL LOT AREA WITHIN PHASE 22 = 0.0 ACRES
 TOTAL LOT AREA WITHIN PHASE 23 = 0.0 ACRES
 TOTAL LOT AREA WITHIN PHASE 24 = 0.0 ACRES
 TOTAL LOT AREA WITHIN PHASE 25 = 0.0 ACRES
 TOTAL LOT AREA WITHIN PHASE 26 = 0.0 ACRES
 TOTAL LOT AREA WITHIN PHASE 27 = 0.0 ACRES
 TOTAL LOT AREA WITHIN PHASE 28 = 0.0 ACRES
 TOTAL LOT AREA WITHIN PHASE 29 = 0.0 ACRES
 TOTAL LOT AREA WITHIN PHASE 30 = 0.0 ACRES

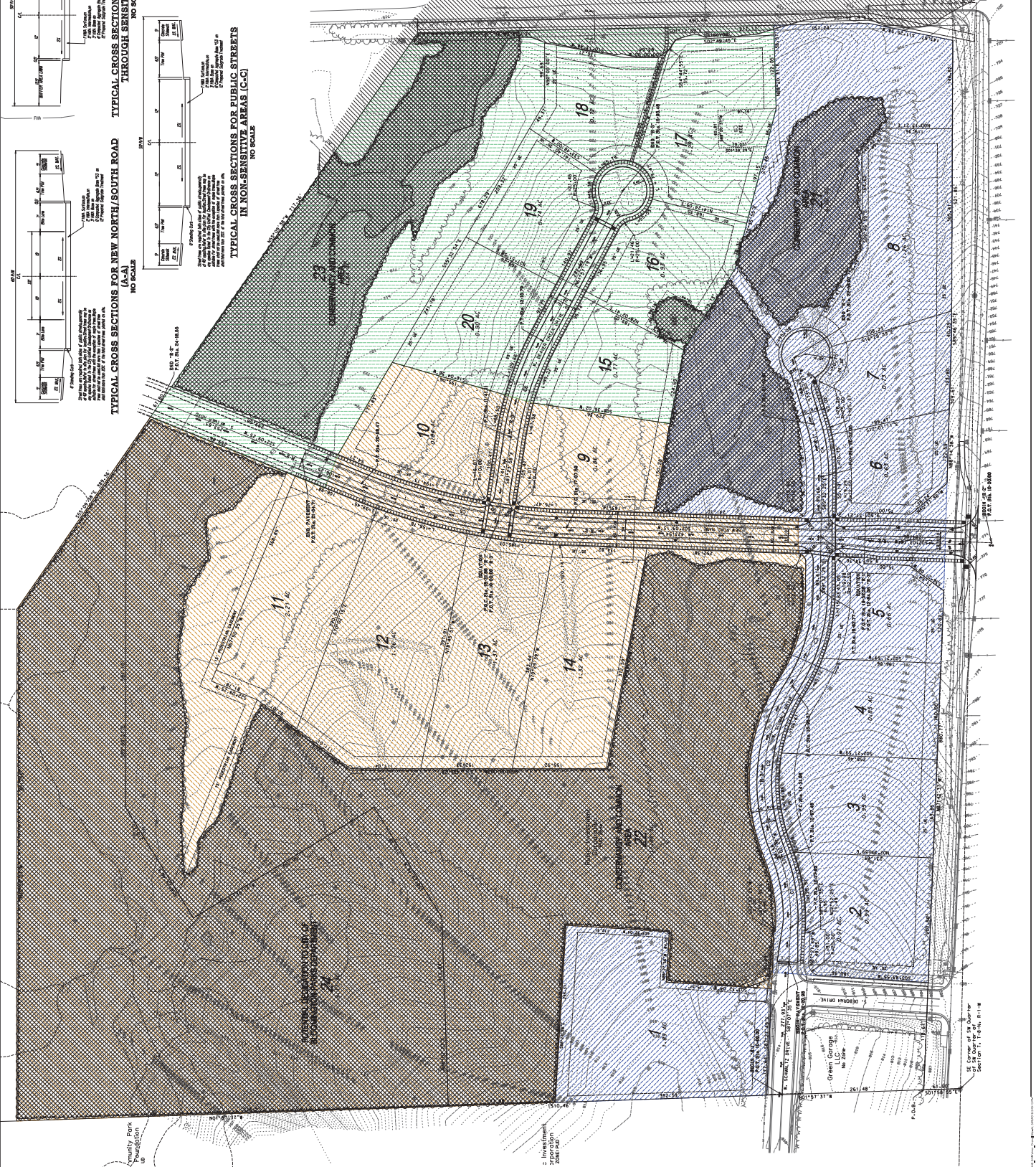

SP
 South Branch & Associates, Inc.
 10000 Highway 101, Suite 100
 Raleigh, North Carolina 27613
 Phone: 919.876.4433
 Fax: 919.876.4433
 www.southbranch.com

DATE: 05/11/18
 SHEET: 2 of 24
 PROJECT: 5449A
 PRELIMINARY PLAN

DEVELOPMENT DATA
 SITE AREA = 543.8 ACRES
 TOTAL LOT AREA = 543.8 ACRES
 TOTAL LOT AREA WITHIN PHASE 2 = 543.8 ACRES
 TOTAL LOT AREA WITHIN PHASE 1 = 0.0 ACRES
 TOTAL LOT AREA WITHIN PHASE 3 = 0.0 ACRES
 TOTAL LOT AREA WITHIN PHASE 4 = 0.0 ACRES
 TOTAL LOT AREA WITHIN PHASE 5 = 0.0 ACRES
 TOTAL LOT AREA WITHIN PHASE 6 = 0.0 ACRES
 TOTAL LOT AREA WITHIN PHASE 7 = 0.0 ACRES
 TOTAL LOT AREA WITHIN PHASE 8 = 0.0 ACRES
 TOTAL LOT AREA WITHIN PHASE 9 = 0.0 ACRES
 TOTAL LOT AREA WITHIN PHASE 10 = 0.0 ACRES
 TOTAL LOT AREA WITHIN PHASE 11 = 0.0 ACRES
 TOTAL LOT AREA WITHIN PHASE 12 = 0.0 ACRES
 TOTAL LOT AREA WITHIN PHASE 13 = 0.0 ACRES
 TOTAL LOT AREA WITHIN PHASE 14 = 0.0 ACRES
 TOTAL LOT AREA WITHIN PHASE 15 = 0.0 ACRES
 TOTAL LOT AREA WITHIN PHASE 16 = 0.0 ACRES
 TOTAL LOT AREA WITHIN PHASE 17 = 0.0 ACRES
 TOTAL LOT AREA WITHIN PHASE 18 = 0.0 ACRES
 TOTAL LOT AREA WITHIN PHASE 19 = 0.0 ACRES
 TOTAL LOT AREA WITHIN PHASE 20 = 0.0 ACRES
 TOTAL LOT AREA WITHIN PHASE 21 = 0.0 ACRES
 TOTAL LOT AREA WITHIN PHASE 22 = 0.0 ACRES
 TOTAL LOT AREA WITHIN PHASE 23 = 0.0 ACRES
 TOTAL LOT AREA WITHIN PHASE 24 = 0.0 ACRES
 TOTAL LOT AREA WITHIN PHASE 25 = 0.0 ACRES
 TOTAL LOT AREA WITHIN PHASE 26 = 0.0 ACRES
 TOTAL LOT AREA WITHIN PHASE 27 = 0.0 ACRES
 TOTAL LOT AREA WITHIN PHASE 28 = 0.0 ACRES
 TOTAL LOT AREA WITHIN PHASE 29 = 0.0 ACRES
 TOTAL LOT AREA WITHIN PHASE 30 = 0.0 ACRES

**BLOOMINGTON PLAN COMMISSION
STAFF REPORT
Location: 3391 S. Walnut Street**

**CASE #: SP-37-21
DATE: December 13, 2021**

PETITIONER: Cedarview Management
601 N. College Ave., Bloomington

CONSULTANTS: Studio 3 Design, Inc.
8604 Allisonville Road, Indianapolis

REQUEST: The petitioner is requesting major site plan approval to allow for the construction of a 33,000 square foot behavioral health facility in the Mixed-Use Corridor (MC) zoning district.

BACKGROUND:

Area: 3.28 acres
Zoning: Mixed-Use Corridor (MC)
Comp Plan Designation: Urban Corridor
Existing Land Use: Undeveloped
Proposed Land Use: Behavioral Health Facility
Surrounding Uses: North – Office
 West – Animal Shelter/Recycling Facility
 East – Single and Multi-family residences
 South – Office

REPORT: The property is located at 3391 S. Walnut Street and is zoned Mixed-Use Corridor (MC). Surrounding zoning includes Mixed-Use Corridor (MC) to the north and south, Residential Multifamily (RM) to the east, and Mixed Use Institutional (MI) to the west. The surrounding properties have been developed with a mix of single and multi-family residences to the east, offices to the north and south, and public service facilities to the west. This site is undeveloped and has several trees along the property border with no known sensitive environmental features.

The Plan Commission approved a primary plat for a two-lot subdivision (DP-33-21) for this property at the November 15, 2021 hearing. The property received a grading permit in 2006 for general site grading and installation of a sidepath and street trees along the frontage. Although the site improvements and limited infrastructure were completed, no development ever occurred at this site and it is undeveloped.

The petitioner is requesting major site plan approval to allow the construction of a 33,000 square foot behavioral health facility for children with autism. There will be one driveway into the site from Walnut Street that is located on the north side of the site to provide access to the parking area. The petitioner is proposing 118 parking spaces with this petition.

MAJOR SITE PLAN REVIEW 20.06.050(a)(2)(C)(ii): Major site plan approval is required for developments that contain more than 15,000 square feet of gross floor area. This proposed site plan will involve the construction of a 33,000 square foot nonresidential building and therefore triggers major site plan review.

DEVELOPMENT STANDARDS & INCENTIVES 20.04: The following UDO standards are required to be reviewed for all activities that require New Development approval.

MC Dimensional Standards:

Building setbacks: The minimum front building setback is 15 feet, the side building setback is 7', and the rear building setback (east) is 7'. The proposed building meets the setback requirements. A type 2 landscape buffer yard is required along the east property line since the adjacent use is residential. This adds an additional 15' setback onto the base setback of the district, so there is a 22' setback along the east property line.

Front parking setback (minimum): The minimum front parking setback is 20 feet behind the primary structure's front building wall. All proposed parking areas meet the front parking setback.

Side parking setback (minimum): The side yard parking setback is 8'. The proposed parking areas all meet the minimum setback.

Minimum Landscape Area (minimum): The minimum landscape area required is 40% and they are proposing 41.5%, which meets this minimum standard.

Primary structure height: The maximum height is four (4) stories not to exceed 50 feet. The proposed building is 23'8" and does not exceed the maximum height standard.

Environment: The property does not have any naturally occurring environmentally sensitive areas. While there are several scattered trees on the property border, there is not a mature canopy that is required to be preserved. There are no known sensitive environmental features.

Steep Slopes: No naturally occurring steep slopes are present.

Siltation and erosion prevention: An erosion control plan has been submitted as part of the proposal. Additionally, a Grading Permit will be required before development can begin on the property. There are no expected siltation or erosion control issues expected with this proposal.

Drainage: A grading and drainage plan has been submitted. There will be several biofiltration areas installed around the property to provide stormwater detention and water quality improvements. A copy has also been submitted to City of Bloomington Utilities for their review. There are no expected drainage issues expected with this proposal.

Riparian Buffer: There are no riparian buffers on the site.

Karst Geology: There are no known karst features on the site.

Wetlands: No wetlands were identified on the site.

Tree and forest preservation: There is no closed canopy on the site. The petitioner will be preserving the existing trees along the east property line adjacent to the buffer yard. This area will also be planted with the required buffer yard trees.

Lake Watershed: There are no watershed issues on the site.

Floodplain: The property is not within a regulated 100-year floodplain.

Access and Connectivity:

Driveways and access: There will be one drivecut into this site from Walnut Street. There are no other driveways within 100' of the proposed drivecut, so the location of the drivecut meets the separation standards.

Bicycle and Pedestrian Facilities: A 10' wide concrete sidewalk is required with the General Urban street typology and the existing 8' wide asphalt sidepath must therefore be

removed along the Walnut Street frontage, this was a requirement of the primary plat approval as well. The building will be accessible via sidewalk from the building to Walnut Street. Internal sidewalks have also been shown through the site and parking areas to provide pedestrian access.

Public Transit: This property is not located on an existing Bloomington Transit service route.

Parking and Loading: The Department has determined that this use would be classified as a school and therefore not have a parking maximum. The petitioner is proposing 118 parking spaces. Since there are more than 50 parking spaces, the UDO requires a minimum of 1 electric vehicle charging station for every 25 spaces, therefore a minimum of 5 electric vehicle charging stations are required. A condition of approval has been included to that effect.

Site and Building Design:

Material: The primary exterior finishing material is brick veneer with metal panels used as a secondary building material. Both of these are permitted. A metal cornice has been shown along some of the parapets to define the caps of the modules.

Exterior Facade: The petitioner has incorporated a series of recessed modules, raised parapets, awnings, and transparent glass throughout the four facades. The proposed façade elevations all meet the requirements of the UDO.

Patterns: A series of masonry banding elements has been incorporated within the modules to provide a horizontal design element and pattern. There are three different colors used on the facades.

Eaves & Roof: The buildings will utilize a flat roof with parapets.

360-Degree Architecture: All four sides of the building show similar architecture and design elements. The building therefore meets the 360 degree architecture requirements.

Primary Pedestrian Entry: A pedestrian entrance has been shown on the west side of the building facing Walnut Street and meets the pedestrian entry requirements through the incorporation of an awning, recessed entry, and prominent building address.

Windows on Primary Facades: All proposed windows on the building are shown to be transparent and therefore are in compliance.

Anti-monotony Standards: There is only one building proposed for this lot so these standards do not apply.

Landscape, Buffering, and Fences: A type 2 buffer yard is required along the east property line because the adjacent use is residential. This adds an additional 15' setback onto the base setbacks of the district and requires one deciduous tree every 25 linear feet and two evergreen trees every 25 linear feet within the buffer yard. These have been shown on the landscape plan. The UDO requires that all portions of a site not covered by structure, parking lot, access way, required buffer yard, or other pervious surface be landscaped. The UDO requires that parking lots with 12 or more parking spaces provide one landscape bumpout, island, or endcap per every 10 parking spaces. Landscape bumpouts, island, and endcaps are required to contain at least one large canopy tree. The proposed site plan appears to meet landscape requirements, including street trees, buffer yards, and interior landscaping. The details of the landscape plan will be verified at the grading permit stage.

Outdoor Lighting: A lighting and photometric plan will have to be submitted which shows that the site meets UDO requirements for maximum light trespass and fixture types during the grading permit review process. No deviations from the lighting code are expected.

SITE PLAN REVIEW: The Plan Commission shall review the major site plan petition and approve, approve with conditions, or deny the petition in accordance with Section 20.06.040(g) (Review and Decision), based on the general approval criteria in Section 20.06.040(d)(6)(B) (General Compliance Criteria).

20.06.040(d)(6)(B) General Compliance Criteria

- i. Compliance with this UDO
- ii. Compliance with Other Applicable Regulations
- iii. Compliance with Utility, Service, and Improvement Standards
- iv. Compliance with Prior Approvals

PROPOSED FINDING: The proposed site plan is compliant with all of the standards of the UDO. A minimum of 5 electric vehicle charging stations are required and must be added to the site plan as noted in the parking section of this report. This approval is consistent with the requirements of the previous primary plat approval. No problems have been identified with meeting all stormwater and utility connections.

CONCLUSION: The proposed site plan meets all of the requirements of the Unified Development Ordinance. The development of this property will allow the construction of an improved multi-use path along the property frontage as well as substantial improvements to the entire property to allow for a supportive behavioral health facility.

RECOMMENDATION: The Planning and Transportation Department recommends that the Plan Commission adopt the proposed findings and approve SP-37-21 with the following conditions:

1. Approved per terms and conditions of Plan Commission case #DP-33-21.
2. The existing asphalt sidepath along the Walnut Street frontage must be removed and a minimum 10' wide concrete sidewalk installed along the entire property frontage.
3. Redraw the location of the tree protection fence to be installed three feet outward from the trees' drip line.
4. A minimum of 5 electric vehicle charging stations are required and must be shown with the grading plan.

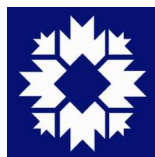

City of Bloomington
Bloomington Environmental Commission

MEMORANDUM

Date: December 13, 2021
To: Bloomington Plan Commission
From: Bloomington Environmental Commission
Subject: DP-33-21: Little Star ABA
3391 S. Walnut Street

The purpose of this memo is to convey the environmental concerns and subsequent recommendations for conditions of approval for this development petition. The Environmental Commission's (EC) objective is that the results of our review and suggestions will lead to enhancement of the ecosystem services provided, and the climate-change mitigation attributes of the site.

Comments

1.) The Tree Protection Fence shown in not in the correct place. The plan shows it at the tree drip line, but it is required to be three feet outward from the drip line per UDO 20.080 (3) Tree Protection.

Recommended Conditions of Approval

1.) Redraw the location of the tree protection fence to be installed three feet outward from the trees' drip line.

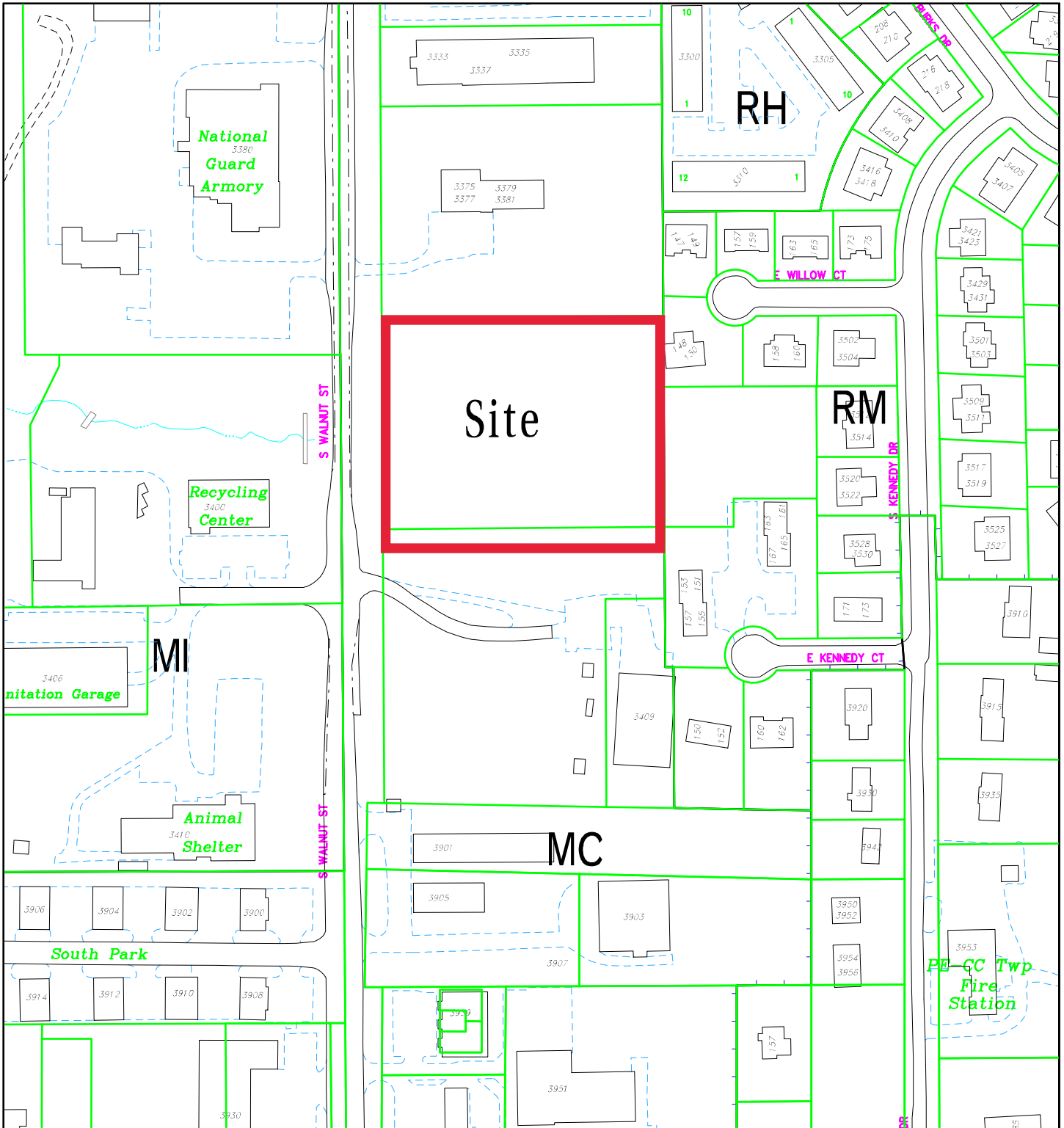

City of Bloomington
Planning

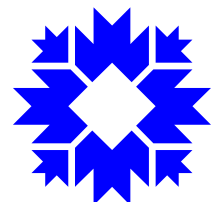

Scale: 1" = 200'

By: greulice
10 Dec 21

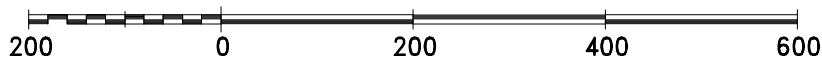

For reference only; map information NOT warranted.

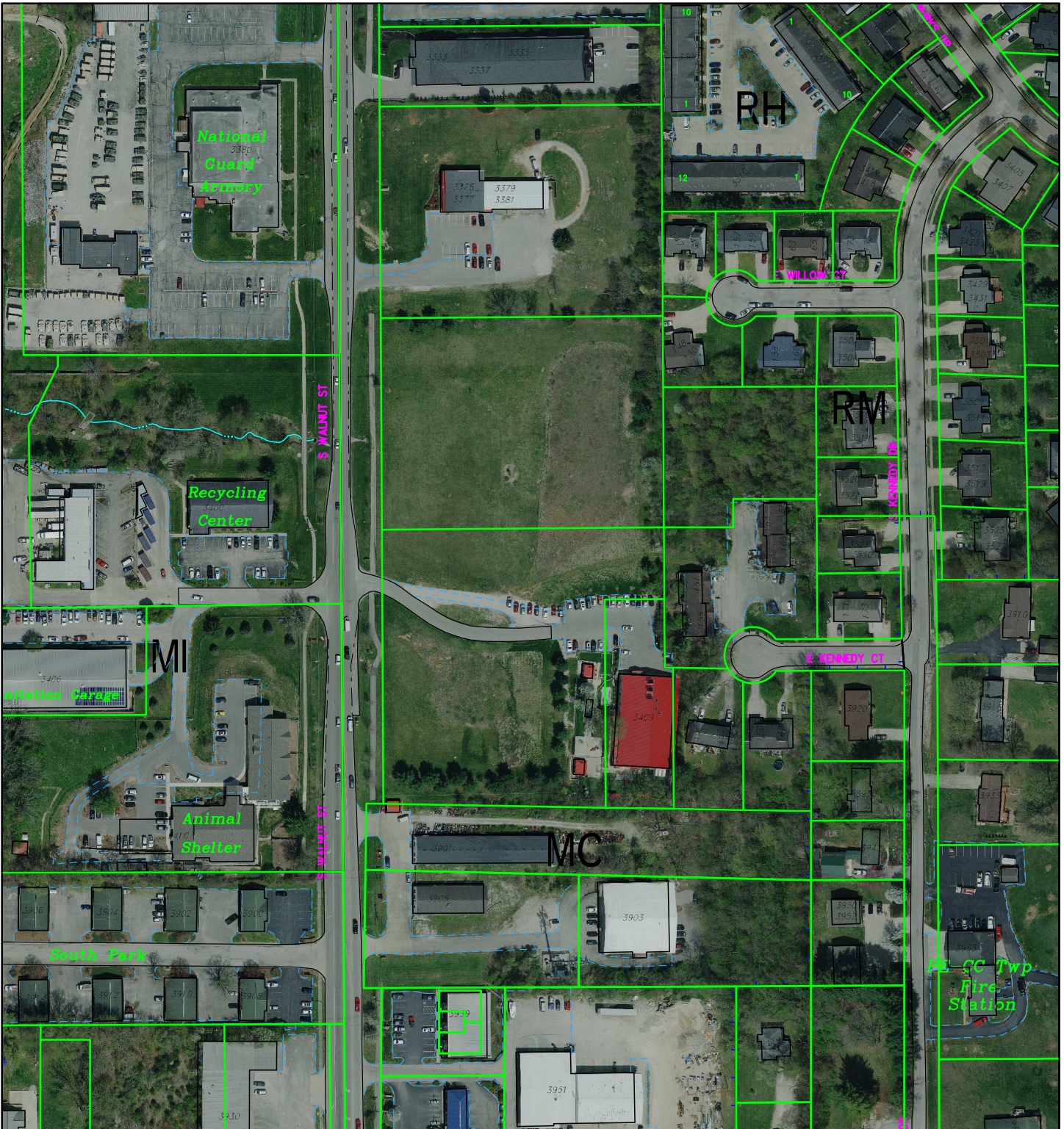

By: greulice
10 Dec 21

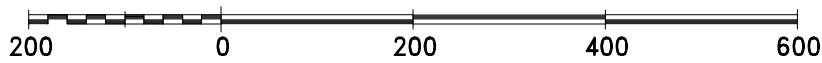

For reference only; map information NOT warranted.

City of Bloomington
Planning

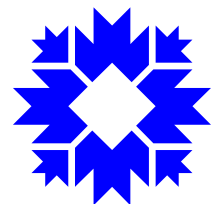

Scale: 1" = 200'



November 29th, 2021
Final Filing

City of Bloomington Planning Department
 P.O. Box 100
 Bloomington, IN 47402

Attn: Mr. Eric Greulich

RE: Little Star ABA

PETITIONERS STATEMENT

Dear Eric;

Studio 3 Design is pleased to submit the attached Behavioral Health Facility for children with Autism, “**Little Star ABA**”. On behalf of our client, **we respectfully request approval of a major development and preliminary plat approval for a (2) two lot subdivision.**

Lot 1 (**3.28 acres**) will be for Little Star ABA development. Lot 2 (**2.187 acres**) will not be developed or included as part of the Little Star project. Total site being divided into two lot subdivision is 5.467acres.

We are requesting that Secondary plat approval be delegated to staff.

The following document outlines the project scope. Please take time to review and contact us with any additional questions.

The attached petition is based on the current UDO.

Project Location

The project site is located on a **5.467**parcel of land that is currently undeveloped on the East side of South Walnut Street. The property is adjacent to 3404 South Walnut (Paws Dog Daycare), though that property is not included in the subdivision request.

Project Description

The project will consist of a single building, purpose built for a single tenant – Little Star ABA. Little Star provides one on one therapy for children and young adults with autism. The behavioral intervention they provide is divided into three age groups – each with their own distinct zone within the facility. The three zones are Early Behavioral Intervention (EBI), Childhood Behavioral Intervention (CBI) and Teen and Adult Behavioral Intervention (TABI). The patients arrive throughout the day and work with their therapist for varying timeframes. Most clients are on site for the majority of the day.

Project Site Access and Drive Functionality:

Access to the property will be through a new northern drive located 162' from the existing drive on the adjacent property.

The north drive provides access to both staff parking and a separate one-way drive zone for patient drop off and over-flow staff parking. Patients will arrive at varying times throughout the day. Unlike a school, there is not a set start time where all patients and staff arrive at the same time. Cars arriving at the North entrance will not be backed up on the drive waiting to drop off patients at the door, instead parents will park and walk their child into the facility. There are two primary entrances with patient only parking lining the sidewalk on the north and east sides of the building. Staff parking can serve as overflow parking (if) there is a large group arriving at the same time. Ample parking has been provided on site to prevent stacking of vehicles out to South Walnut Street. A turnaround is provided on the south end of the parking lot for fire trucks as well as parents who are dropping off teenagers or young adults at the East entrance.

Outdoor picnic and playground areas have been incorporated into the design. The playground/ picnic areas will be secured with fencing to keep patients safe on site in a controlled environment.

Building Entrances:

The building has (3) distinct points of entry and one exit only location on the South facade. One building entrance facing Walnut Street that serves access to outdoor space and the public sidewalk, one entrance facing to the north that serves as the primary entry for (EBI) and (CBI) patients as well as staff from the north parking lot. One entrance facing the East which serves TABI (teenager and young adult) patients as well as staff parking and one entrance facing South that serves primarily as a means of egress. Each primary entrance has a canopy cover at the door, lighting and is articulated to be viewed as a building entrance. Each entry point will be ADA accessible and served by an accessible route.

Parking Counts & request for added parking.

The UDO allows for 3.3 parking spaces per 1000 sf of building area for this facility.

The building gross square footage is **32,785 sf**, therefore **108 spaces allowed**.

As designed, the site provides for **118 spaces** for patient and staff needs (13 patient spaces, 105 staff spaces).

We are requesting a staff level approval to provide for **10 parking spaces over the maximum parking allowed**. We have reduced this request from the initial which was asking for 19 extra parking spaces. We base this request on the following unique situation:

1. This is a Behavioral Health Facility serving children with Autism. It is categorized as a business in lieu of a school (which has no maximum on parking).
2. The Behavioral Health model is to provide (1) therapist per child to work with the child on behavioral intervention and coping techniques.
3. There are 100 work stations/ patient cubicles provided on-site, requiring 100 therapists when fully occupied – we are assuming 10% will be out at any given time placing our need at 90 staff therapist and 15 additional management staff.
4. There are an additional 15 staff members, (12 program managers, 3 supervisors, and 1 receptionist. This leaves a **minimum of 13** empty spaces at peak load for parent drop off and pick-up as well as visitor spaces for new clients for a total of **118 spaces**.
5. We have based the number on the knowledge that in the mornings and evenings there should be an overlap where not all staff is in yet or some have left for the day- this will allow for roughly **20 -25 spaces to be used by parents for drop-off and pick-up**.

6. Drop off and pick-up is also unique in that children are either meet by their therapist at the car or a parent walks them in. Patients/ children are not left unattended- thus driving the need for available parking for patients.

Setbacks

All building and parking setbacks for the project meet or exceed the required setbacks outlined in the UDO.

Building Materials and Massing

The building is designed with 360 degree architecture. The building massing is a single story with a rhythm of building modules, 40' max in width, that step back or push out from the primary facade. The modules incorporate changes in vertical height, zones of glazing, canopies, awnings and changes in materials- all in line with the façade requirements contained in the UDO. There are two primary pop up zones that call out interior group gathering areas for exercise and dining. These raised zones are also articulated with a change in materials and larger expanses of glazing for natural light. Smaller activity and learning spaces are further defined in the massing as raised volumes pushing out of the main building mass. Entrance points are articulated and highlighted with pedestrian scaled canopies that reach out to the parking lots and provide shelter for patients as they approach the building.

Building materials are kept simplistic for a clean, defined appearance. Two colors of utility brick will wrap the façade on 4 sides. Cast stone profiles create a simple water table that aligns with glazing mullions and caps areas of rock-faced cast stone panels. Together these elements form a horizontal band that defines the buildings base. Cast stone, both smooth and rock-faced are used to highlight window sills and heads. The raised zones defining group gathering spaces will be clad in a metal panel system that provides a rich vibrant color in contrast to the more subdued brick and stone façade. Storefront glazing wraps the building and is organized based on the function of the space behind it. 12' storefront will be provided at the large group gathering areas, 8'-8" storefront will be located at common area activity and learning zones as well as points of entry, and punched openings starting at 5'-4" aff will be provided in patient areas to allow natural light while maintaining privacy and limiting distraction for the patients while they are working in their one on one settings.

Bike Storage/ Parking

Bike racks will be provided for staff to meet the Ordinance requirements for those that that may live close enough to commute. Patients will always be brought to site by a parent/ guardian in a vehicle and escorted into the facility to prevent a patient from wondering off or getting out to the street. A total of (6) spaces are provided per UDO requirements (5 percent of the provided 118 parking spaces). The bike parking is located at the East entrance.

Site Environmental Conditions

Impervious surface coverage permitted by zoning is 60%. As designed, impervious surface coverage will be **58.5%**. There are no karst features, steep slopes, water resources or floodway areas on site. The existing tree line areas along the east and north property lines will be preserved.

Building Signage

(2) tenant wall signs, one facing Walnut street near the West building entrance and one facing the North parking lot at the north building entrance are provided. Each will be an internally illuminated, surface applied wall signage falling within the size guidelines for the MC zoning district. Additional wall signage depicting the building address will be incorporated on the North and East building façade canopies. These signs will be raised applied numbers / letters. Additional directional signage and parking lot signage will be provided on site.

Building and Site Exterior Lighting:

Site lighting will be handled with pole lighting in the parking lot with light levels cut off to avoid intrusion into neighboring lots. Building entrances will be lit with downlighting

Environmental Building Considerations

The developer is interested in providing a building that is sensitive to the concerns of today's-built environment. The building will be designed to meet the requirements of the IECC and ASHRAE Standard 90.1, as well as several state-specific codes as required by the federal government. As such, we are reviewing the incorporation of the following into the project:

- "Green friendly" building materials – This includes both materials with recycled content as well as building materials that have been harvested and manufactured within a 500-mile radius. Examples of these materials include cementitious siding/panels, brick, CMU blocks, and cast concrete.
- High efficiency appliances and building systems.
- Energy efficient windows with low-E glazing
- White reflective roofing membrane for energy conservation and reduced heat island effect.
- Use of larger window openings for natural day lighting of interior spaces to cut down on the use of artificial lighting and promote healthy environments in group areas.
- Energy efficient lighting fixtures (LED) throughout the project
- Bike parking for staff (6) spaces
- Recycling is provided on site.
- The incorporation of native vegetation in landscape zones
- Maintained existing tree line around North and West perimeter of site.
- (4) Car charging stations are provided in the East parking lot near the staff entrance.

Encroachments:

- Non- Required

Trash Removal

Trash removal has been provided off of the drive on the South side of the building. The grade will be leveled at this location to assist in the roll-out of trash containers on pick-up days. The location is easily accessible to staff as well as the trash collection and recycling collection companies.

A dumpster enclosure matching the building materials will be provided on site for trash and recycle material.

Site Utilities

There are existing sanitary sewer, water and storm water facilities on the site from a previously proposed development. Some lines are within easement and others are not. The project will remove and or relocate utility lines not necessary for this development and place permanent easement along lines to remain and lines that cross through this site to serve adjacent properties.

The existing sanitary sewer, water and storm water facilities can meet the project needs for service. Water service for domestic and fire suppression will be brought in at the south side of the building. A riser room will be located near the South entrance.

Sanitary will exit the building to the North tying into existing lines on site.

Electrical will be feed from Walnut Street to a new transformer located at the Southeast corner of the building/ site with access from the driveway. Primary electrical room will be in core of the building along with the telecommunications room.

Storm Water Management

Water quantity and water quality requirements will be addressed through the construction of rain gardens and storm water detention basins within and adjacent to the parking lot. All surface runoff will be directed through a rain garden to enhance water quality prior to discharge to the municipal collection system. Rain garden areas will be planted with the appropriate native seed mixture. The larger storm water detention basin on site may need to be fenced to prevent clients/ children from potentially gaining access to the area following a rain when there may be water standing in the pond.

Site Landscape

The existing tree lines along the north and east property lines will be preserved. A Type 3 Buffer yard is required along the east property line. Existing trees within the tree line can meet the deciduous tree requirement. A 6' opaque screen fence will be installed in lieu of a row of evergreen trees to complete the buffer yard requirement. Parking lot perimeter, street tree and interior landscaping will meet code requirements.

Public Improvements for Subdivision

The Thorofare Plan prescribes a right-of-way width of 90' (45' half) from centerline for South Walnut Street. The existing right-of-way along this property is 50' from centerline. As such, no additional right-of-way dedication will be required. The Thorofare Plan also calls for a 10' concrete sidewalk along the property's frontage. The existing 7'-8' wide asphalt path will be removed and replaced with a 10' wide sidewalk. Street trees will also be installed at 40' spacing along the property's frontage. No other public improvements are required.

Variances

We do not anticipate the need for any variances to the UDO with this submittal.

Respectfully submitted,

STUDIO 3 DESIGN, INC



Tim Cover, Architect

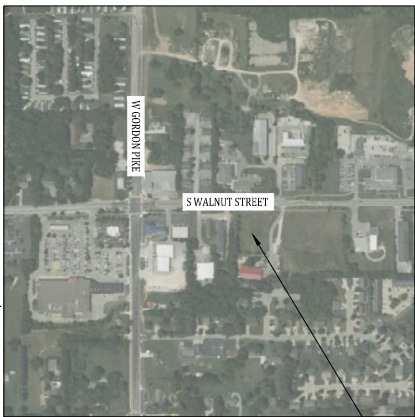

PROJECT LOCATION

VICINITY MAP
NO SCALE

**LITTLE STAR
ABA THERAPY
BLOOMINGTON, INDIANA**
3400 S. WALNUT STREET

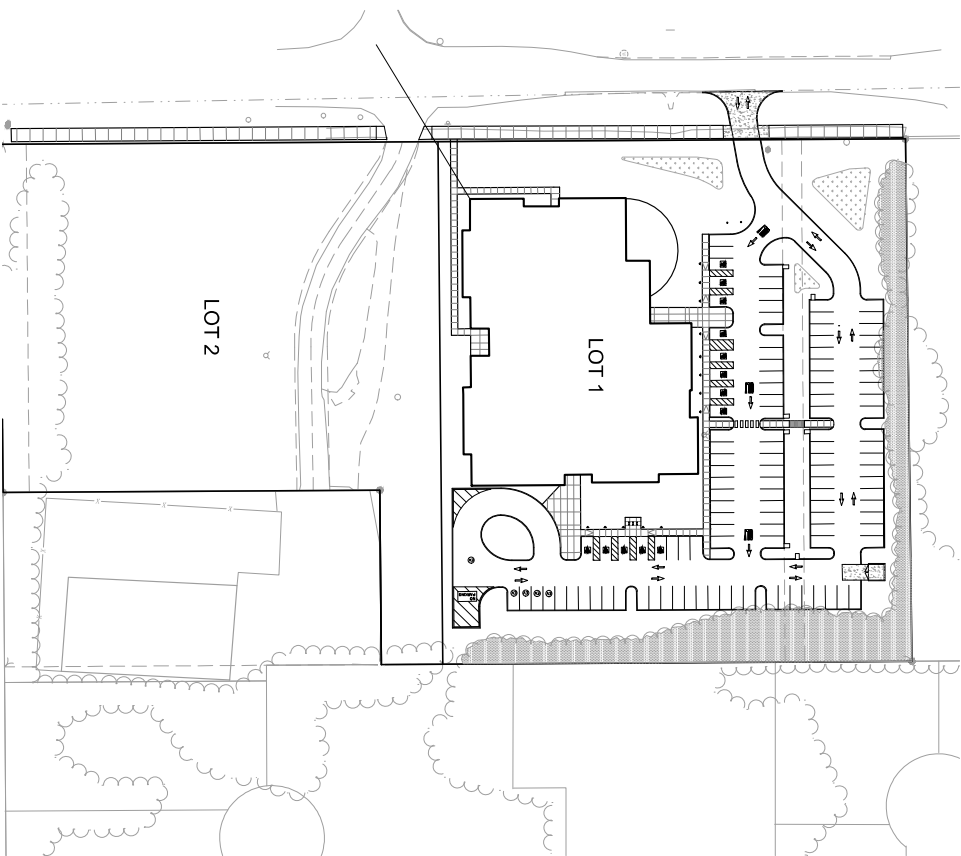

SITE MAP
NO SCALE

LOCATION
BLOOMINGTON, INDIANA
NO SCALE

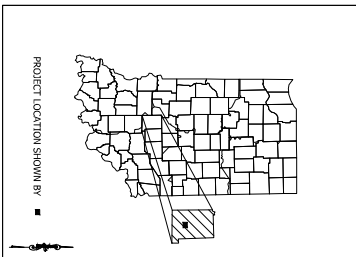

PLANS PREPARED BY:

BANNING ENGINEERING
855 COLUMBIAN ROAD SUITE #101
BLOOMINGTON, IN 47403
BUS (317) 207-3700
FAX (317) 207-3700
EMAIL: Banning@banning-engineering.com
WWW: www.banning-engineering.com
CONTACT: PROJECT MANAGER
1
EMAIL: Steve@banning-eng.com

CONSTRUCTION DOCUMENTS	
PROJECT MANAGER:	DATE:
<small>THESE PLANS ARE NOT TO BE CONSIDERED FINAL OR TO BE UTILIZED FOR CONSTRUCTION UNLESS SIGNED AND DATED BY THE APPROPRIATE BANNING REPRESENTATIVE. THESE PLANS ARE NOT INTENDED TO BE SUPERSEDED AS A RECTIFICATION OR ORIGINAL BOUNDARY SURVEY. A ROUTE SURVEY OR A SURVEYOR'S LOCATION REPORT...</small>	

**NOT FOR
CONSTRUCTION**

CERTIFIED BY: _____

SHEET NO	DESCRIPTION
C100	TITLE SHEET
C101	PROLOG
C102	REVISION PLAN
C103	GRADING PLAN
C104	SITE PLAN
C105	UTILITY PLAN
C106	UTILITY PROFILES
C107	DETAILS
C108	CONSTRUCTION PLAN
C109	PRELIMINARY PLAT

REVISIONS		
NUMBER	DESCRIPTION	DATE

THE LATEST EDITION OF BANNING ENGINEERING'S STANDARD SET TO THE EXTENT INDICATED THEREIN. PART OF THIS PLAN



Date: 10/31/2021
Project No: 21567
Sheet No: C100

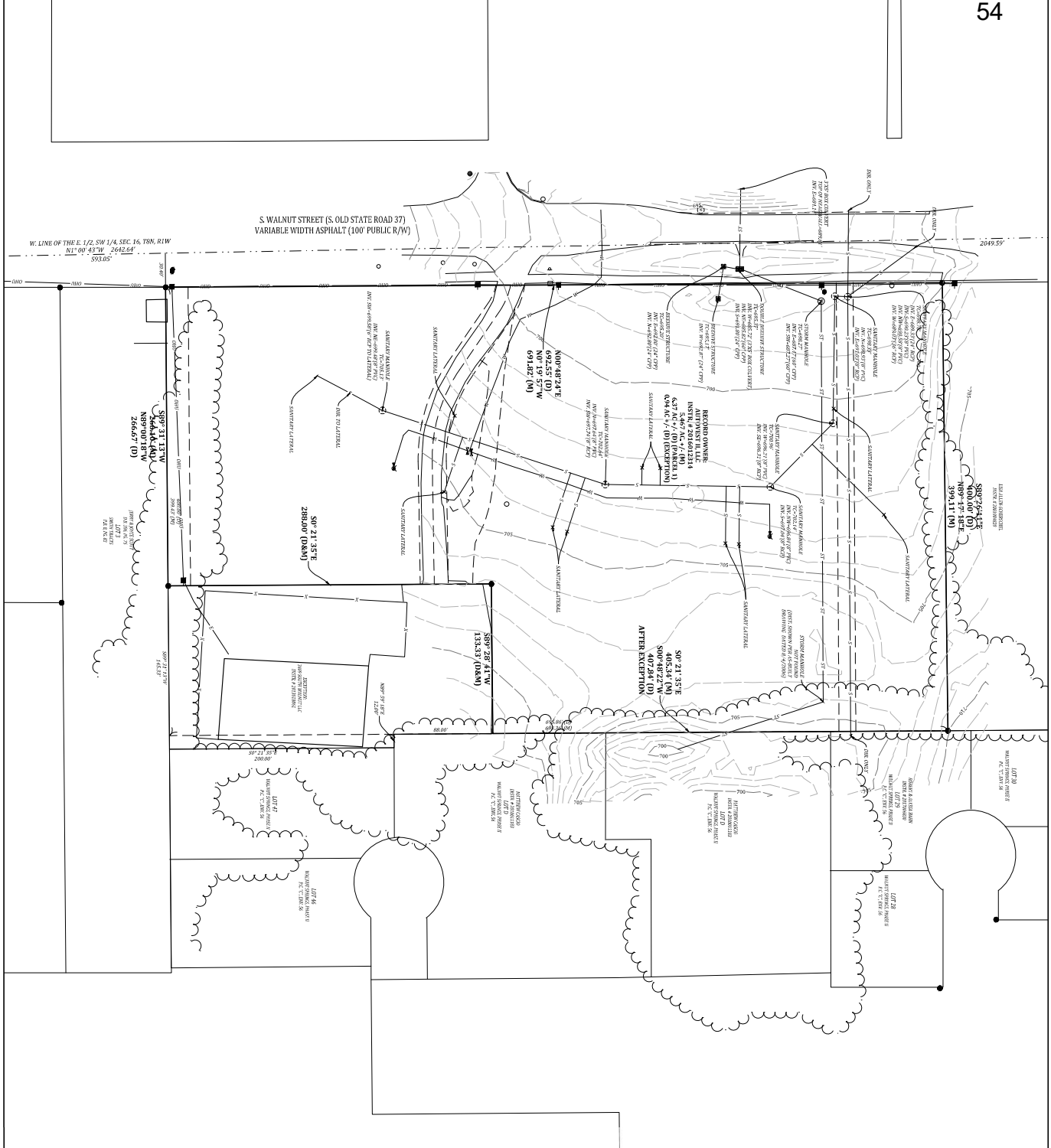

Map Unit Legend

Map Unit Symbol	Name	Notes	Color
---	Property Line	As Shown in CAD	Red
---	Survey Boundary	As Shown in CAD	Black
---	Topographic Contour	As Shown in CAD	Grey
---	Utility Line	As Shown in CAD	Blue
---	Sanitary Sewer	As Shown in CAD	Orange
---	Water Main	As Shown in CAD	Green
---	Telephone Main	As Shown in CAD	Purple
---	Gas Main	As Shown in CAD	Yellow

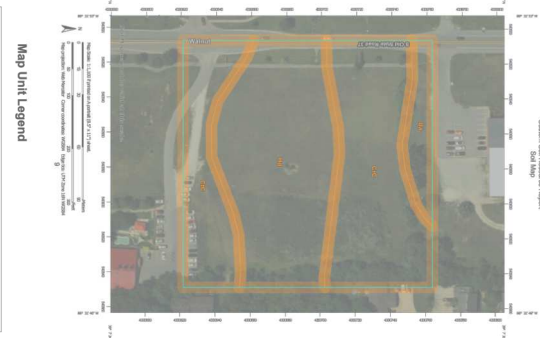

Legend

- L-1 (GROUND)
- C-1 (REAR BEARING POINT)
- C-2 (FRONT BEARING POINT)
- C-3 (REAR BEARING POINT)
- C-4 (FRONT BEARING POINT)
- C-5 (REAR BEARING POINT)
- C-6 (FRONT BEARING POINT)
- C-7 (REAR BEARING POINT)
- C-8 (FRONT BEARING POINT)
- C-9 (REAR BEARING POINT)
- C-10 (FRONT BEARING POINT)
- C-11 (REAR BEARING POINT)
- C-12 (FRONT BEARING POINT)
- C-13 (REAR BEARING POINT)
- C-14 (FRONT BEARING POINT)
- C-15 (REAR BEARING POINT)
- C-16 (FRONT BEARING POINT)
- C-17 (REAR BEARING POINT)
- C-18 (FRONT BEARING POINT)
- C-19 (REAR BEARING POINT)
- C-20 (FRONT BEARING POINT)
- C-21 (REAR BEARING POINT)
- C-22 (FRONT BEARING POINT)
- C-23 (REAR BEARING POINT)
- C-24 (FRONT BEARING POINT)
- C-25 (REAR BEARING POINT)
- C-26 (FRONT BEARING POINT)
- C-27 (REAR BEARING POINT)
- C-28 (FRONT BEARING POINT)
- C-29 (REAR BEARING POINT)
- C-30 (FRONT BEARING POINT)
- C-31 (REAR BEARING POINT)
- C-32 (FRONT BEARING POINT)
- C-33 (REAR BEARING POINT)
- C-34 (FRONT BEARING POINT)
- C-35 (REAR BEARING POINT)
- C-36 (FRONT BEARING POINT)
- C-37 (REAR BEARING POINT)
- C-38 (FRONT BEARING POINT)
- C-39 (REAR BEARING POINT)
- C-40 (FRONT BEARING POINT)
- C-41 (REAR BEARING POINT)
- C-42 (FRONT BEARING POINT)
- C-43 (REAR BEARING POINT)
- C-44 (FRONT BEARING POINT)
- C-45 (REAR BEARING POINT)
- C-46 (FRONT BEARING POINT)
- C-47 (REAR BEARING POINT)
- C-48 (FRONT BEARING POINT)
- C-49 (REAR BEARING POINT)
- C-50 (FRONT BEARING POINT)

BANNING ENGINEERING
 853 COLUMBIA ROAD, SUITE #101
 ELAMINFIELD, IN 46106
 BUS: (317) 707-3700, FAX: (317) 707-3800
 E-MAIL: Banning@BanningEngineering.com
 WEB: www.BanningEngineering.com

S100

Project No: 21287
 Sheet No:

NOT FOR CONSTRUCTION

EXISTING TOPOGRAPHY
LITTLE STAR ABA THERAPY
3400 S. WALNUT STREET
BLOOMINGTON, INDIANA

Designed	Drawn	Checked	Scale	Date
AGL	AGL		1" = 40'	11/21/21

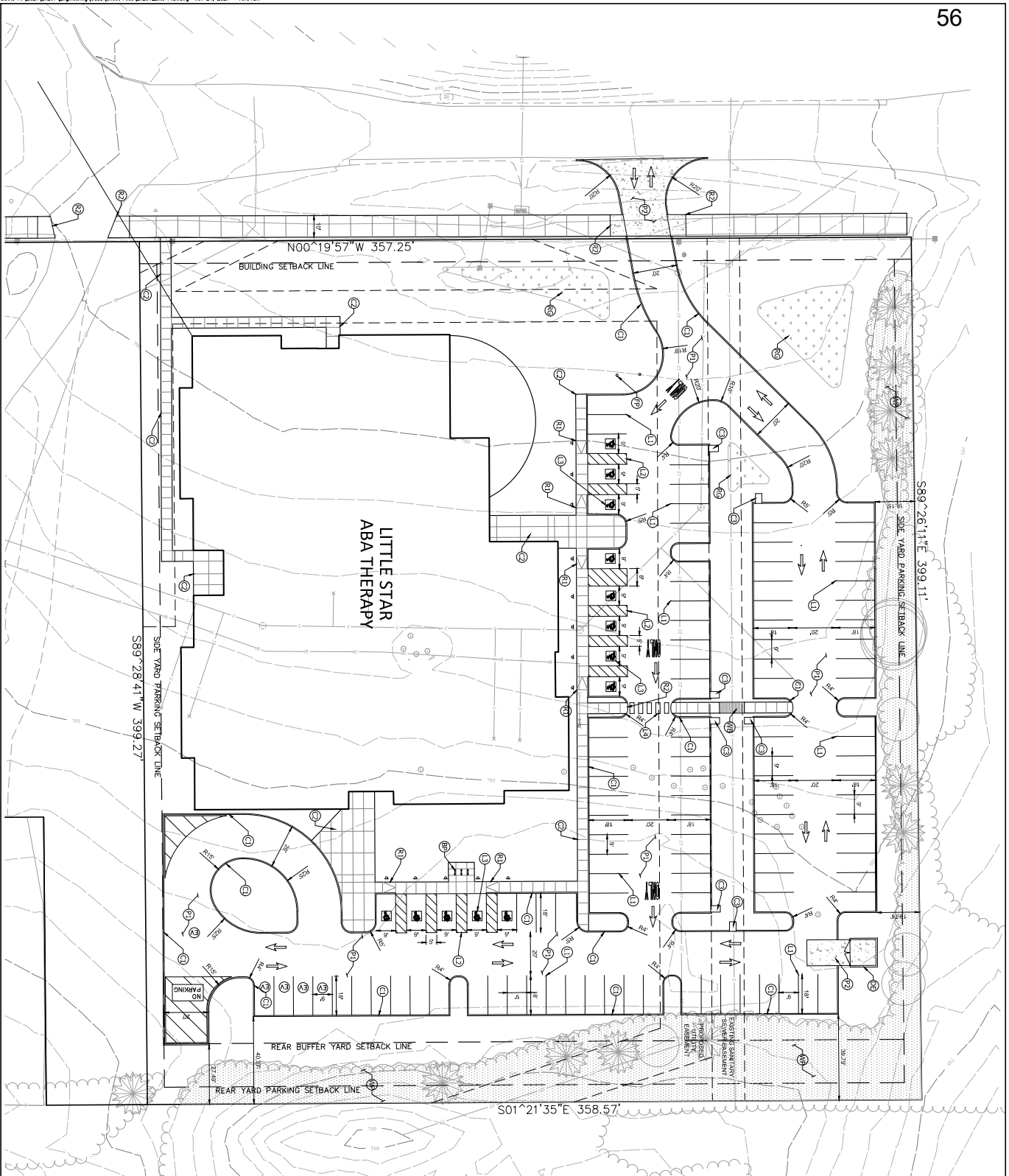

EXISTING STANDARDS
 ALL DIMENSIONS ARE IN FEET AND INCHES UNLESS OTHERWISE NOTED.
 DIMENSIONS TO FACE UNLESS OTHERWISE NOTED.
 DIMENSIONS TO CENTERLINE UNLESS OTHERWISE NOTED.
 DIMENSIONS TO SURFACE UNLESS OTHERWISE NOTED.
 DIMENSIONS TO CENTERLINE UNLESS OTHERWISE NOTED.
 DIMENSIONS TO SURFACE UNLESS OTHERWISE NOTED.
 DIMENSIONS TO CENTERLINE UNLESS OTHERWISE NOTED.

- MATERIALS LEGEND**
- ① HMA PAVEMENT
 - ② 3" HMA BASE ON CONCRETE BASE
 - ③ CEMENT CONCRETE CURB
 - ④ 4" POLYMER CONCRETE ON 4" HMA
 - ⑤ CURB, 4" FINISHING
 - ⑥ CONCRETE SIDEWALK, WIDTH VARIES
 - ⑦ 4" CONCRETE ACCESSIBLE RISE
 - ⑧ CURB TYPED
 - ⑨ CONCRETE CUTTERS
 - ⑩ ACCESSIBLE RAMP, PERPENDICULAR
 - ⑪ ACCESSIBLE RAMP, PARALLEL
 - ⑫ LINE, PAINT, SOLID WHITE, 4" CROSSWALK
 - ⑬ ACCESSIBLY SYMBOL, PAINT, BLUE
 - ⑭ LINE, PAINT, SOLID WHITE, 4" CROSSWALK
 - ⑮ SHAN GARDEN
 - ⑯ STRUCT. PARKING, W/PROP WALK
 - ⑰ UNPAVED DRIVEWAY
 - ⑱ UNPAVED DRIVEWAY
 - ⑳ WALK BIPODE
 - ㉑ FLAME POLE

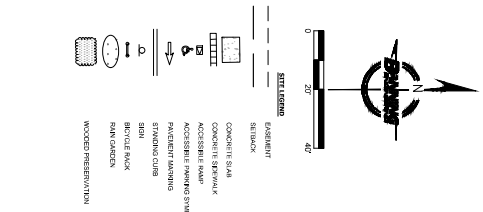

BANNING ENGINEERING
 853 COLUMBIA ROAD, SUITE #101
 PLAINFIELD, IN 46166
 BUS: (317) 707-3700, FAX: (317) 707-3800
 E-MAIL: Banning@BanningEngineering.com
 WEB: www.BanningEngineering.com

NOT FOR CONSTRUCTION

SITE PLAN
 LITTLE STAR ABA THERAPY
 3400 S. WALNUT STREET
 BLOOMINGTON, INDIANA

Designed:	Surf:	Rev. Notes	Date
Drawn:	AGL	XXXXXXXXXXXXXXXXXXXXXXXXXXXX	XXXXXX
Checked:			
Scale:	1" = 40'		
Date:	10/12/21		

Project No: 21287
 Sheet No: C102

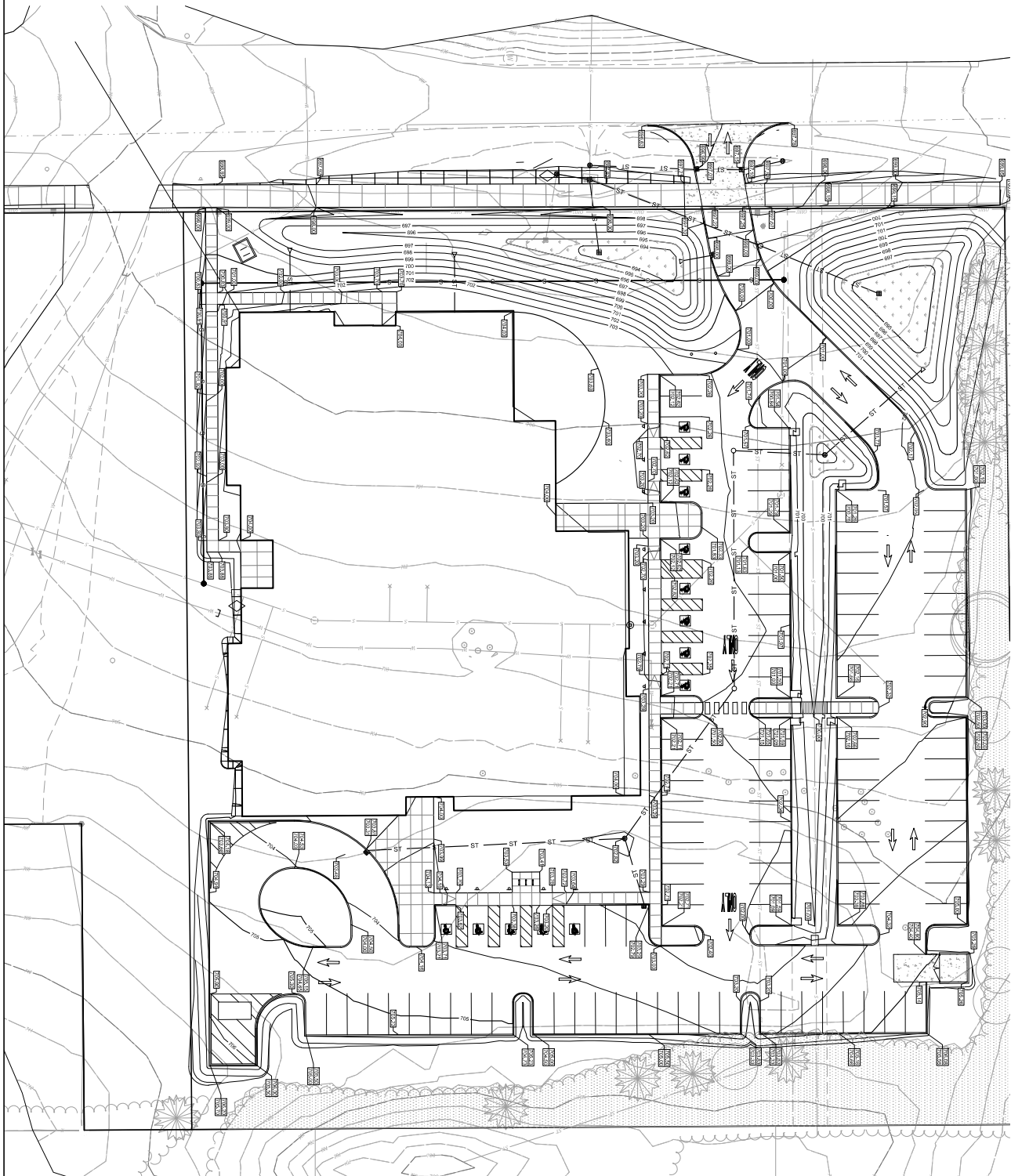

- GRADING PLAN NOTES**
1. ELECTION POINTS SHOWN ARE AT HIGHEST SPOTS.
 2. ELECTION POINTS SHOWN ARE AT HIGHEST SPOTS.
 3. THE EXISTING GRADE IS INDICATED BY DASHED LINES AND THE PROPOSED GRADE IS INDICATED BY SOLID LINES.
 4. THE PROPOSED GRADE IS TO BE MAINTAINED AT ALL TIMES UNLESS OTHERWISE NOTED.
 5. THE PROPOSED GRADE IS TO BE MAINTAINED AT ALL TIMES UNLESS OTHERWISE NOTED.
 6. THE PROPOSED GRADE IS TO BE MAINTAINED AT ALL TIMES UNLESS OTHERWISE NOTED.
 7. THE PROPOSED GRADE IS TO BE MAINTAINED AT ALL TIMES UNLESS OTHERWISE NOTED.
 8. THE PROPOSED GRADE IS TO BE MAINTAINED AT ALL TIMES UNLESS OTHERWISE NOTED.
 9. THE PROPOSED GRADE IS TO BE MAINTAINED AT ALL TIMES UNLESS OTHERWISE NOTED.
 10. THE PROPOSED GRADE IS TO BE MAINTAINED AT ALL TIMES UNLESS OTHERWISE NOTED.

PLAN
 SHOWN THE SET IN A FORM OF PRELIMINARY APPROXIMATION. IT IS NOT A CONTRACT DOCUMENT AND IS NOT TO BE USED FOR CONSTRUCTION. ANY CHANGES TO THIS PLAN SHALL BE MADE BY A REVISION SHEET.
 EXISTING = DASHED LINES
 PROPOSED = SOLID LINES
 FINISH GRADE = DOTTED LINES
 ELEVATIONS = FEET ABOVE SEA LEVEL

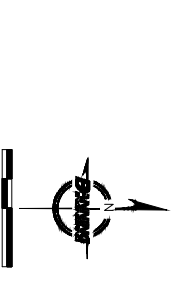
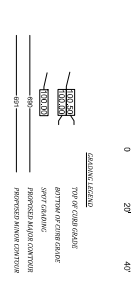
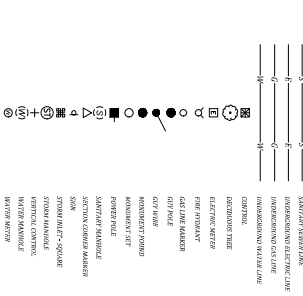

BANNING ENGINEERING
 853 COLUMBIA ROAD, SUITE #101
 PLAINFIELD, IN 46166
 BUS: (317) 707-3700, FAX: (317) 707-3800
 E-MAIL: Banning@BanningEngineering.com
 WEB: www.BanningEngineering.com

NOT FOR CONSTRUCTION

GRADING PLAN
 LITTLE STAR ABA THERAPY
 3400 S. WALNUT STREET
 BLOOMINGTON, INDIANA

Designed	Drawn	Checked	Scale	Date
Sum	X	AG	1" = 20'	10/12/21
Rev. 0001	XXXXXXXXXXXXXXXXXXXXXXXXXXXXXXXXXXXX			
Date				XXXXXX

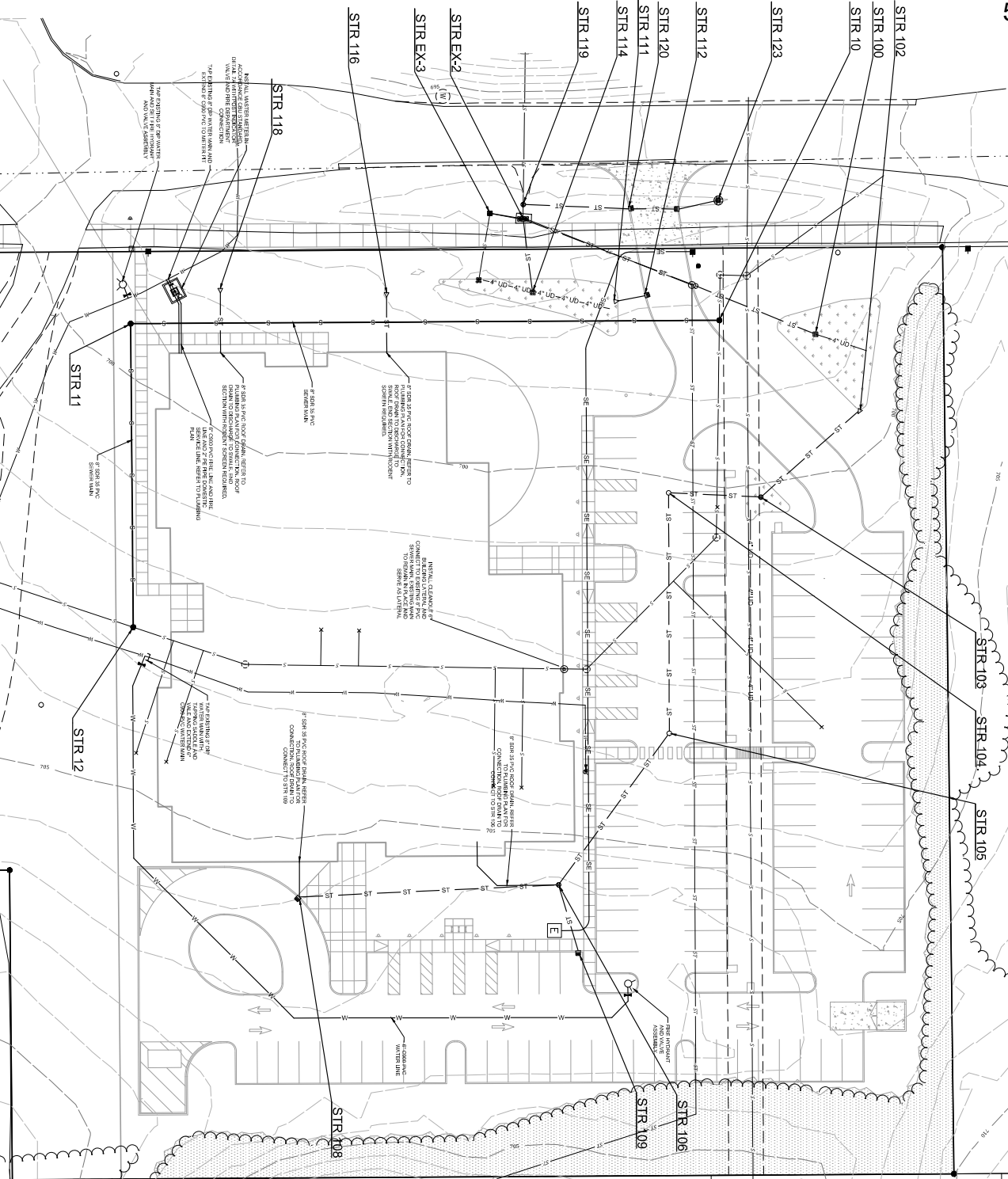

UTILITY NOTES

1. ALL PROJECTS WILL REQUIRE A PRECONSTRUCTION MEETING WITH THE CITY OF BLOOMINGTON. CONTACT THE CITY ENGINEER AT (317) 846-0100 TO SCHEDULE THE MEETING.
2. ALL UTILITY LOCATIONS SHOWN ON THIS PLAN ARE BASED ON RECORD DRAWINGS AND FIELD SURVEY. THE CITY ENGINEER SHALL VERIFY THE LOCATION AND DEPTH OF ALL UTILITIES PRIOR TO CONSTRUCTION OF ANY WATER SERVICE OR SANITARY SERVICE CONNECTIONS. THE CITY ENGINEER SHALL VERIFY THE LOCATION AND DEPTH OF ALL UTILITIES PRIOR TO CONSTRUCTION OF ANY WATER SERVICE OR SANITARY SERVICE CONNECTIONS.
3. THE PROJECTING ENGINEER HAS CONDUCTED VISUAL INSPECTIONS AND SURVEYS OF THE EXISTING UTILITIES AND HAS FOUND NO OBVIOUS CONFLICTS WITH THE PROPOSED UTILITY LAYOUT. HOWEVER, THE PROJECTING ENGINEER HAS NOT CONDUCTED ANY TESTS TO VERIFY THE LOCATION AND DEPTH OF THE UTILITIES. THE CONTRACTOR SHALL VERIFY THE LOCATION AND DEPTH OF ALL UTILITIES PRIOR TO CONSTRUCTION.
4. ALL UTILITIES SHOWN ON THIS PLAN SHALL BE INSTALLED AND TESTED IN ACCORDANCE WITH THE CITY OF BLOOMINGTON'S UTILITY STANDARDS AND SPECIFICATIONS. THE CONTRACTOR SHALL BE RESPONSIBLE FOR OBTAINING ALL NECESSARY PERMITS AND APPROVALS FROM THE CITY OF BLOOMINGTON.
5. ALL UTILITIES SHALL BE INSTALLED IN ACCORDANCE WITH THE CITY OF BLOOMINGTON'S UTILITY STANDARDS AND SPECIFICATIONS. THE CONTRACTOR SHALL BE RESPONSIBLE FOR OBTAINING ALL NECESSARY PERMITS AND APPROVALS FROM THE CITY OF BLOOMINGTON.
6. IN ACCORDANCE WITH SECTION 15.5.1.1 OF THE CITY OF BLOOMINGTON'S UTILITY STANDARDS AND SPECIFICATIONS, THE CONTRACTOR SHALL BE RESPONSIBLE FOR OBTAINING ALL NECESSARY PERMITS AND APPROVALS FROM THE CITY OF BLOOMINGTON.
7. THE CONTRACTOR SHALL BE RESPONSIBLE FOR OBTAINING ALL NECESSARY PERMITS AND APPROVALS FROM THE CITY OF BLOOMINGTON.
8. THE CONTRACTOR SHALL BE RESPONSIBLE FOR OBTAINING ALL NECESSARY PERMITS AND APPROVALS FROM THE CITY OF BLOOMINGTON.
9. THE CONTRACTOR SHALL BE RESPONSIBLE FOR OBTAINING ALL NECESSARY PERMITS AND APPROVALS FROM THE CITY OF BLOOMINGTON.
10. THE CONTRACTOR SHALL BE RESPONSIBLE FOR OBTAINING ALL NECESSARY PERMITS AND APPROVALS FROM THE CITY OF BLOOMINGTON.

BANNING ENGINEERING
 853 COLUMBIA ROAD, SUITE #101
 PLAINFIELD, IN 46166
 BUS: (317) 707-3700, FAX: (317) 707-3800
 E-MAIL: Banning@BanningEngineering.com
 WEB: www.BanningEngineering.com

UTILITY PLAN
LITTLE STAR ABA THERAPY
3400 S. WALNUT STREET
BLOOMINGTON, INDIANA

Designed: []
 Drawn: []
 Checked: []
 Scale: 1" = 30'
 Date: 10/21/21

Project No: 21227
 Sheet No: C104



NOT FOR CONSTRUCTION

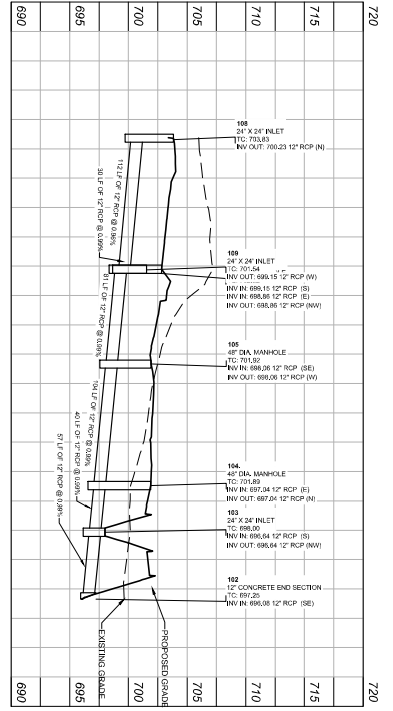

STORM PROFILE STR 108 - STR 102

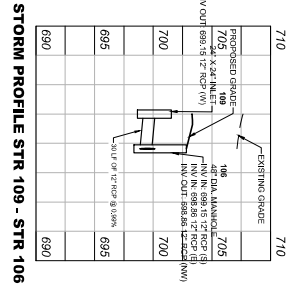

STORM PROFILE STR 109 - STR 106

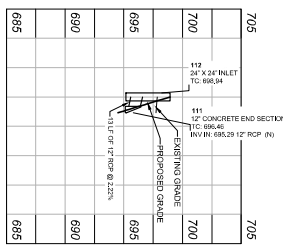

STORM PROFILE STR 112 to STR 111

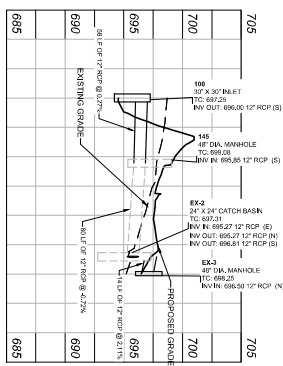

STORM PROFILE STR 100 - STR 114

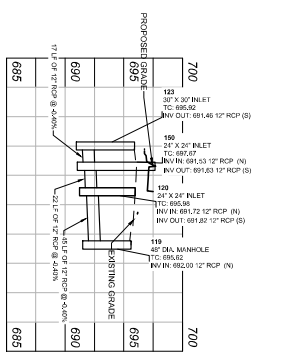

STORM PROFILE STR 123 - STR 119

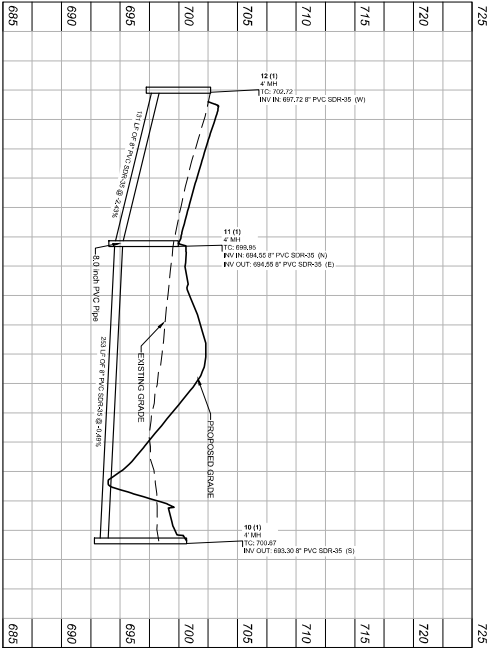

SANITARY SEWER PROFILE STR 10 - STR 12

Designed	Syn.	Revisions	Date
Drawn:	AG		
Checked:			
Scale:			
Date:	10/01/12		

UTILITY PROFILES
 LITTLE STAR ABA THERAPY
 3400 S. WALNUT STREET
 BLOOMINGTON, INDIANA



Project No: 21221
 Sheet No: C105

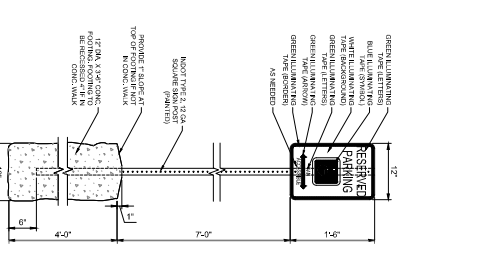
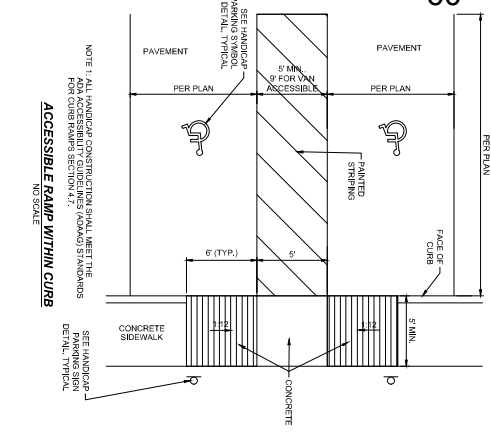

ACCESSIBLE PARKING SIGN
PER PLAN

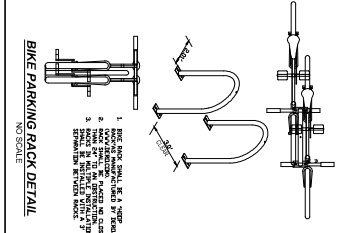

BIKE PARKING RACK DETAIL
NO SCALE

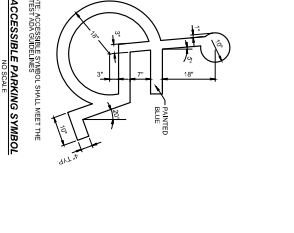

ACCESSIBLE PARKING SYMBOL
NO SCALE

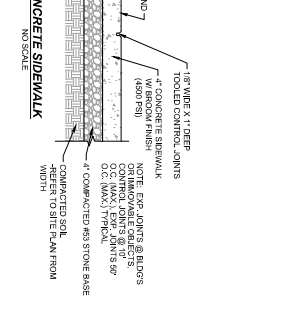

CONCRETE SIDEWALK
NO SCALE

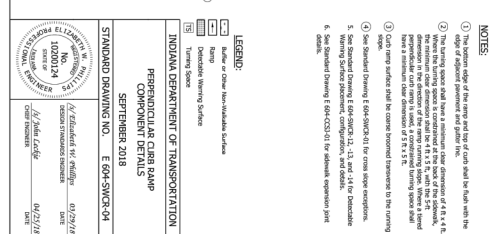
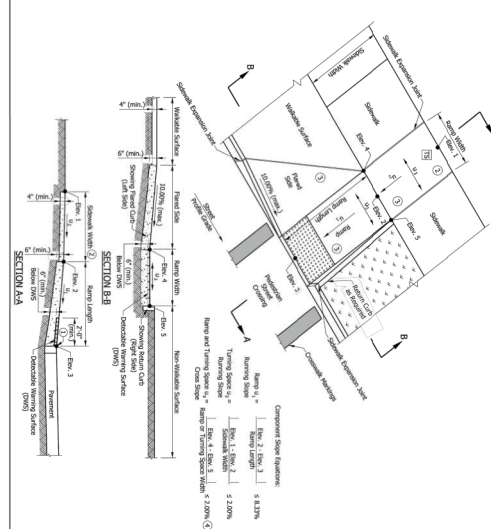

NOTES:

- The bottom edge of new ramp and top of curb shall be flush with the edge of adjacent pavement and gutter line.
- When the curb ramp is to be installed in the center of a block, the curb ramp shall be 8'-0" wide, unless otherwise noted. When a curb ramp is installed at the edge of a block, the curb ramp shall be 5'-0" wide, unless otherwise noted. When a curb ramp is installed at the end of a block, the curb ramp shall be 5'-0" wide, unless otherwise noted.
- Curb ramp surface shall be concrete finished to the wearing surface.
- See Standard Drawing E-604-SWCR-08 for curb ramp construction.
- When the curb ramp is to be installed in the center of a block, the curb ramp shall be 8'-0" wide, unless otherwise noted. When a curb ramp is installed at the edge of a block, the curb ramp shall be 5'-0" wide, unless otherwise noted. When a curb ramp is installed at the end of a block, the curb ramp shall be 5'-0" wide, unless otherwise noted.
- See Standard Drawing E-604-SWCR-08 for sidewalk expansion joint construction.

LEGEND:

**INDIANA DEPARTMENT OF TRANSPORTATION
PERPENDICULAR CURB RAMP
COMPONENT DETAILS
SEPTEMBER 2018**

STANDARD DRAWING NO. E-604-SWCR-08

Author: H. W. Eastman
Checked: H. W. Eastman
Date: 03/29/18

Author: A. J. Allen
Checked: A. J. Allen
Date: 04/25/18

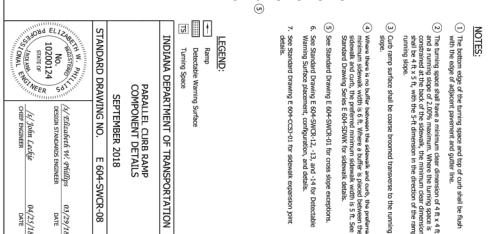
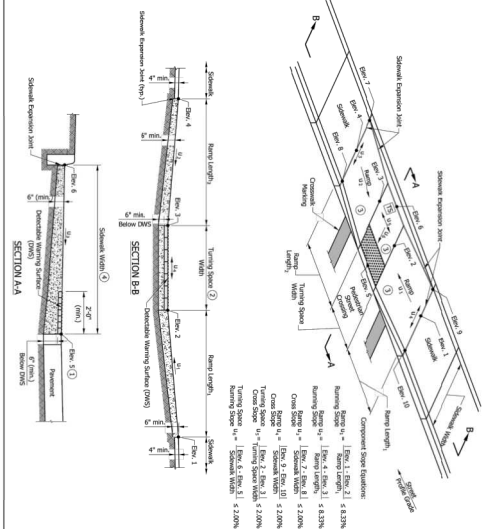

NOTES:

- The bottom edge of new ramp and top of curb shall be flush with the edge of adjacent pavement and gutter line.
- When the curb ramp is to be installed in the center of a block, the curb ramp shall be 8'-0" wide, unless otherwise noted. When a curb ramp is installed at the edge of a block, the curb ramp shall be 5'-0" wide, unless otherwise noted. When a curb ramp is installed at the end of a block, the curb ramp shall be 5'-0" wide, unless otherwise noted.
- Curb ramp surface shall be concrete finished to the wearing surface.
- See Standard Drawing E-604-SWCR-08 for curb ramp construction.
- When the curb ramp is to be installed in the center of a block, the curb ramp shall be 8'-0" wide, unless otherwise noted. When a curb ramp is installed at the edge of a block, the curb ramp shall be 5'-0" wide, unless otherwise noted. When a curb ramp is installed at the end of a block, the curb ramp shall be 5'-0" wide, unless otherwise noted.
- See Standard Drawing E-604-SWCR-08 for sidewalk expansion joint construction.

LEGEND:

**INDIANA DEPARTMENT OF TRANSPORTATION
PARALLEL CURB RAMP
COMPONENT DETAILS
SEPTEMBER 2018**

STANDARD DRAWING NO. E-604-SWCR-08

Author: H. W. Eastman
Checked: H. W. Eastman
Date: 03/29/18

Author: A. J. Allen
Checked: A. J. Allen
Date: 04/25/18

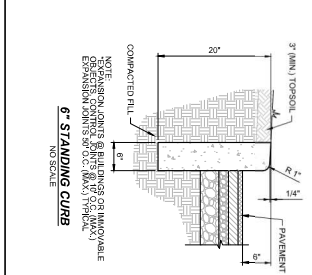

6" STANDING CURB
NO SCALE

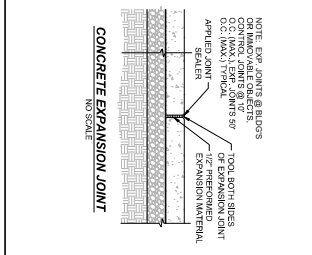

CONCRETE EXPANSION JOINT
NO SCALE

NOT FOR CONSTRUCTION

DETAILS
LITTLE STAR ABA THERAPY
3400 S. WALNUT STREET
BLOOMINGTON, INDIANA

BANNING ENGINEERING
853 COLUMBIA ROAD, SUITE #101
PLAINFIELD, IN 46166
BUS: (317) 707-3700, FAX: (317) 707-3800
E-MAIL: Banning@BanningEngineering.com
WEB: www.BanningEngineering.com

Designed By:	Surf: X	Revisions:	Date:
Drawn:	AGL	XXXXXXXXXXXXXXXXXXXXXXXXXXXX	XXXXXX
Checked:			
Scale:	1"=XX'		
Date:	10/11/21		

Sheet No: 21287
C109

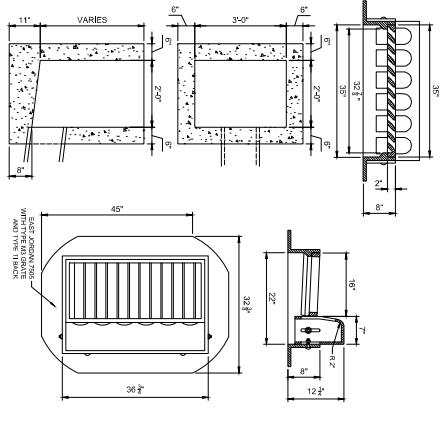
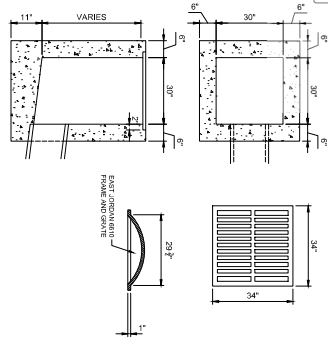
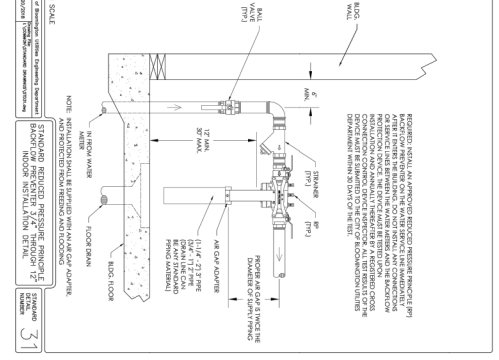
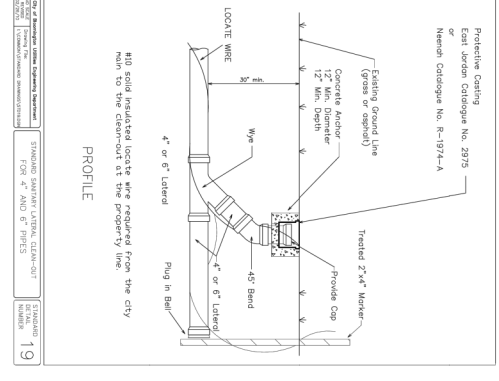
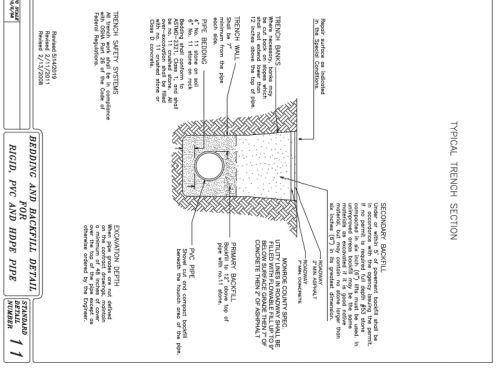
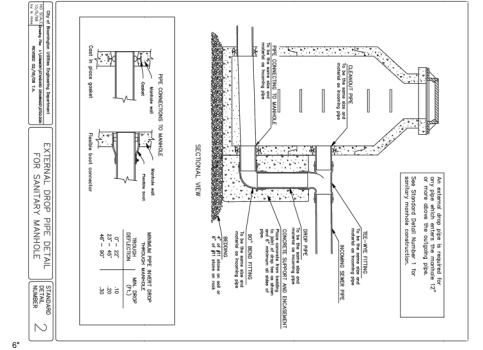
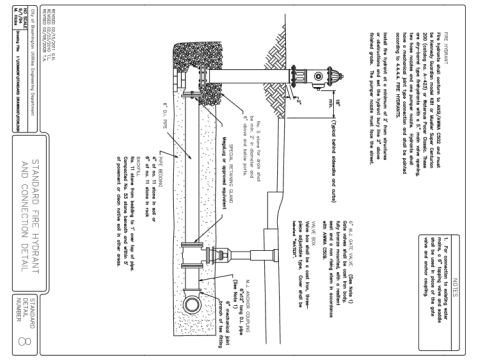
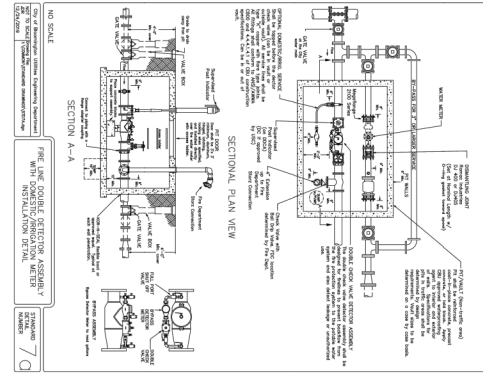
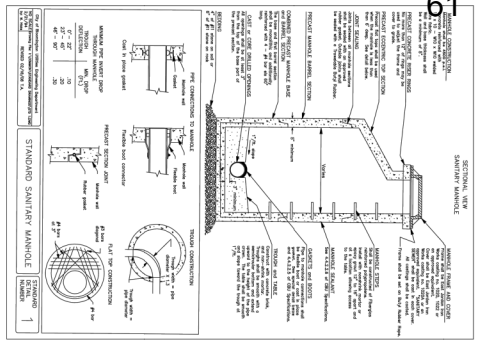

Designed:	Sum.	Revisions:	Date:
Drawn:	X	XXXXXXXXXXXXXXXXXXXXXXXXXXXX	XXXXXX
Checked:	AG		
Scale:	1" = 4'		
Date:	10/01/21		

NOT FOR CONSTRUCTION
 DETAILS
 LITTLE STAR ABA THERAPY
 3400 S. WALNUT STREET
 BLOOMINGTON, INDIANA

BANNING ENGINEERING
 853 COLUMBIA ROAD, SUITE #101
 FARMERSVILLE, IN 46130
 BUS: (317) 707-3700, FAX: (317) 707-3800
 E-MAIL: Banning@BanningEngineering.com
 WEB: www.BanningEngineering.com

Sheet No: 21267
 Project No: C110

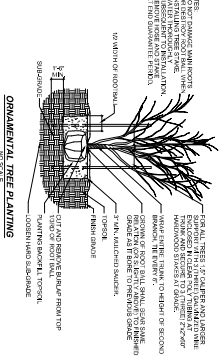
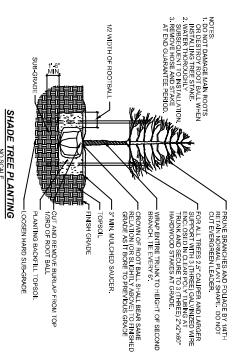
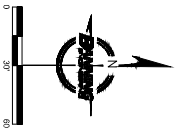
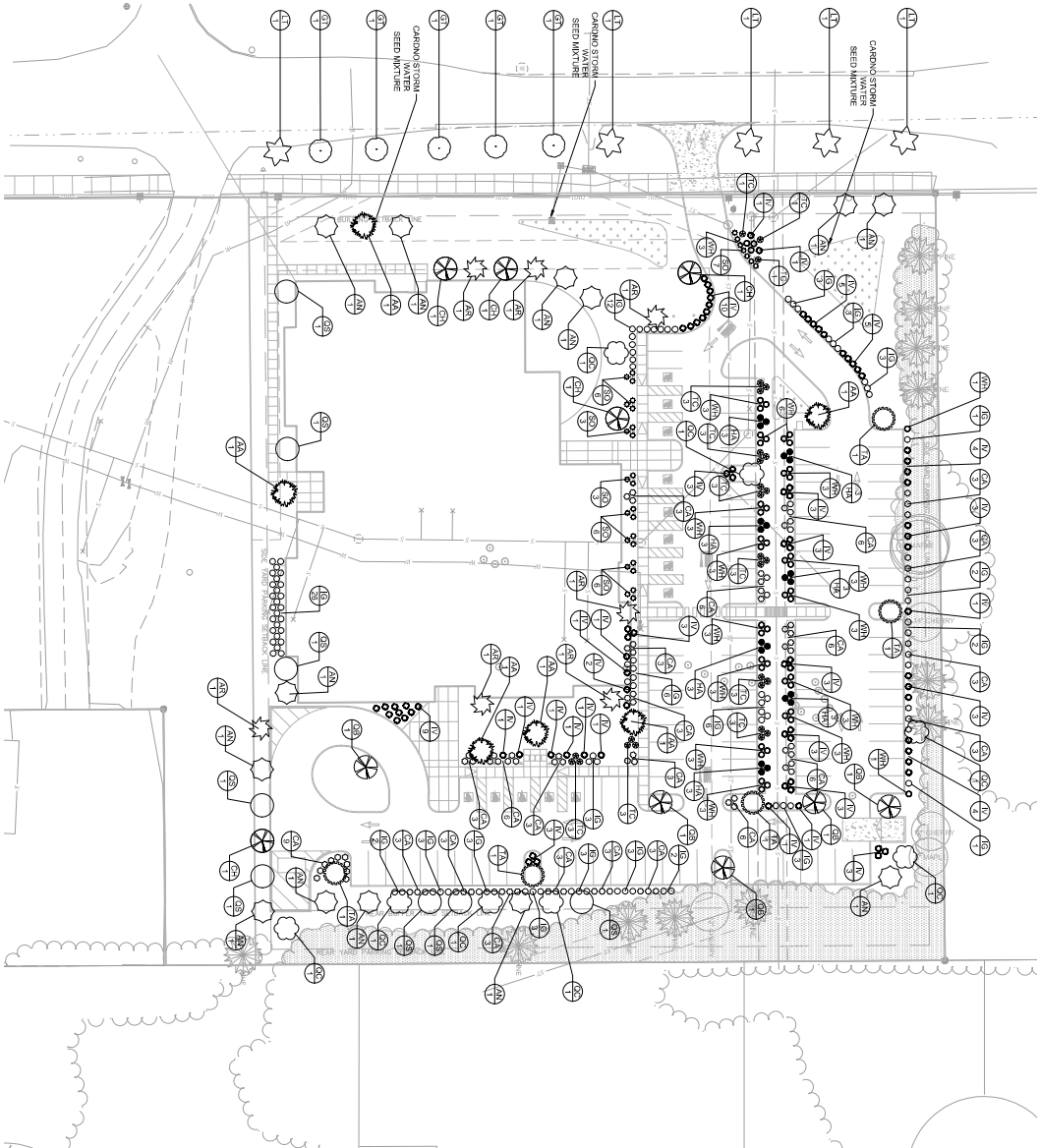

Quantity	Symbol	Scientific Name	Common Name	Size
1	10A	Quercus prinus	White Oak	2" Caliber
1	10B	Quercus alba	White Oak	2" Caliber
1	10C	Quercus macrocarpa	White Oak	2" Caliber
1	10D	Quercus falcata	White Oak	2" Caliber
1	10E	Quercus prinus	White Oak	2" Caliber
1	10F	Quercus alba	White Oak	2" Caliber
1	10G	Quercus macrocarpa	White Oak	2" Caliber
1	10H	Quercus falcata	White Oak	2" Caliber
1	10I	Quercus prinus	White Oak	2" Caliber
1	10J	Quercus alba	White Oak	2" Caliber
1	10K	Quercus macrocarpa	White Oak	2" Caliber
1	10L	Quercus falcata	White Oak	2" Caliber
1	10M	Quercus prinus	White Oak	2" Caliber
1	10N	Quercus alba	White Oak	2" Caliber
1	10O	Quercus macrocarpa	White Oak	2" Caliber
1	10P	Quercus falcata	White Oak	2" Caliber
1	10Q	Quercus prinus	White Oak	2" Caliber
1	10R	Quercus alba	White Oak	2" Caliber
1	10S	Quercus macrocarpa	White Oak	2" Caliber
1	10T	Quercus falcata	White Oak	2" Caliber
1	10U	Quercus prinus	White Oak	2" Caliber
1	10V	Quercus alba	White Oak	2" Caliber
1	10W	Quercus macrocarpa	White Oak	2" Caliber
1	10X	Quercus falcata	White Oak	2" Caliber
1	10Y	Quercus prinus	White Oak	2" Caliber
1	10Z	Quercus alba	White Oak	2" Caliber



FLOOR PLAN

LITTLE STAR ABA THERAPY

3/64" = 1'-0"

11/29/2021

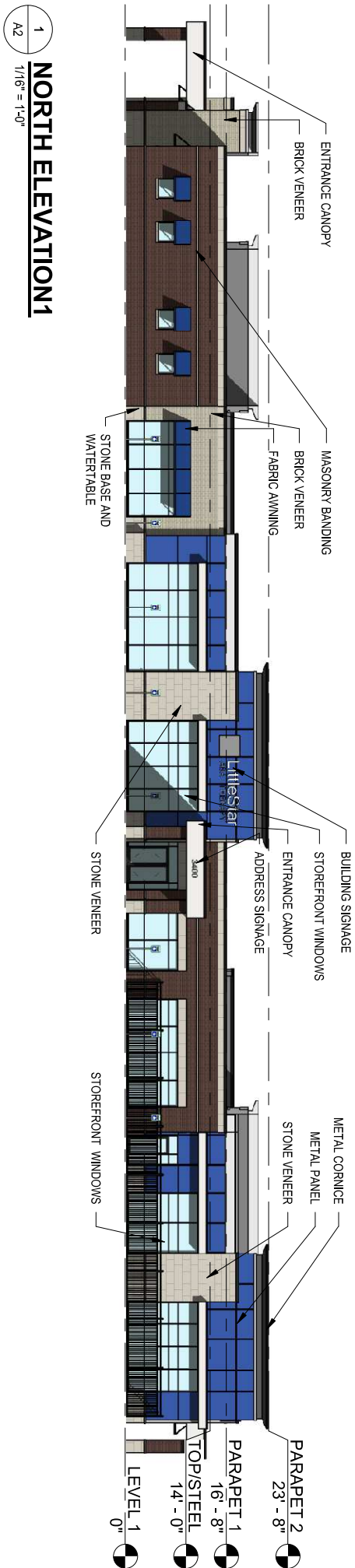

1
NORTH ELEVATION1
1/16" = 1'-0"

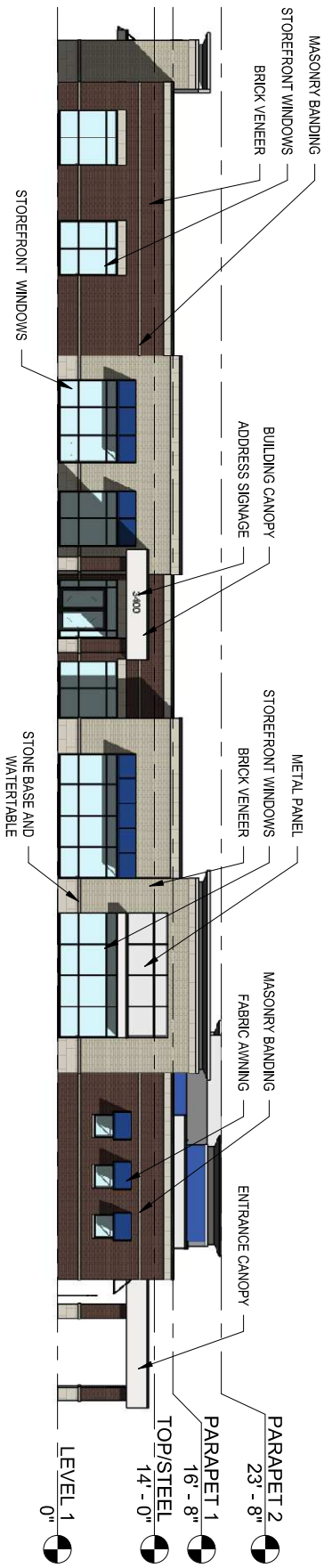

2
EAST ELEVATION
1/16" = 1'-0"

ELEVATIONS

LITTLE STAR ABA THERAPY

11/29/2021

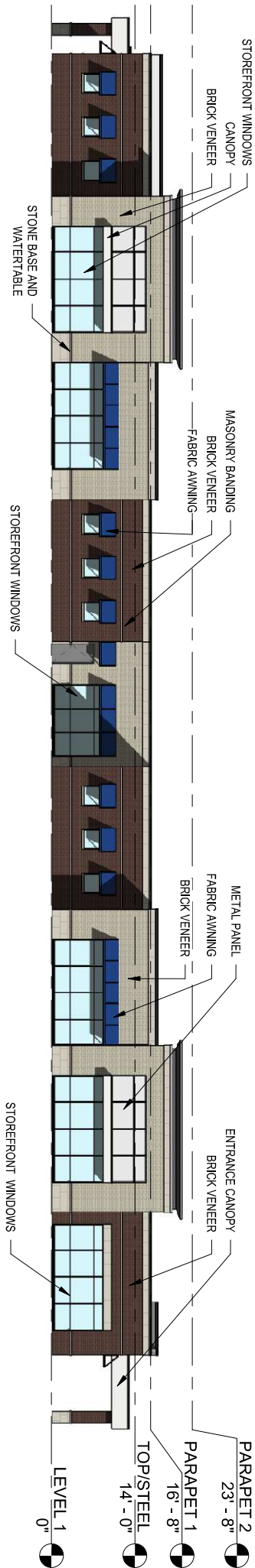

1 SOUTH ELEVATION
1/16" = 1'-0"

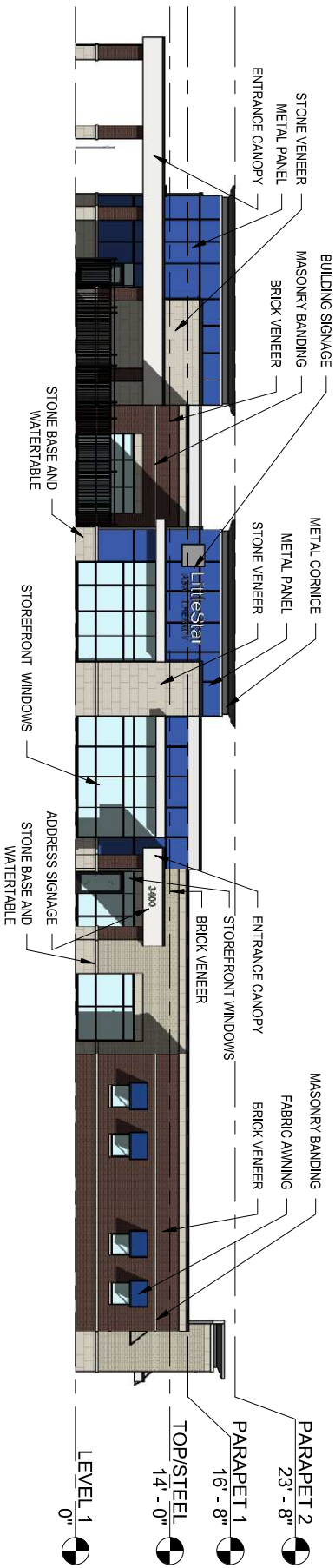

2 WEST ELEVATION
1/16" = 1'-0"

ELEVATIONS

LITTLE STAR ABA THERAPY

11/29/2021



NORTHWEST RENDERING

LITTLE STAR ABA THERAPY

11/29/2021

STUDIO THREE DESIGN
Architecture • Interior Design
8604 Allisonville Road
Suite 330
Indianapolis, IN 46250
Phone: (317) 595.1000
Fax: (317) 572.1236



NORTHEAST RENDERING

LITTLE STAR ABA THERAPY

11/29/2021

STUDIO THREE DESIGN
Architecture • Interior Design
8604 Allisonville Road
Suite 330
Indianapolis, IN 46250
Phone: (317) 595.1000
Fax: (317) 572.1236



SOUTHWEST RENDERING

LITTLE STAR ABA THERAPY

11/29/2021

STUDIO THREE DESIGN
Architecture • Interior Design
8604 Allisonville Road
Suite 330
Indianapolis, IN 46250
Phone: (317) 595.1000
Fax: (317) 572.1236



SOUTHEAST RENDERING

LITTLE STAR ABA THERAPY

11/29/2021

**STUDIO
THREE
DESIGN**
Architecture • Interior Design
8604 Allisonville Road
Suite 330
Indianapolis, IN 46250
Phone: (317) 595.1000
Fax: (317) 572.1236



AERIAL RENDERING

LITTLE STAR ABA THERAPY

11/29/2021

STUDIO THREE DESIGN
Architecture • Interior Design
8604 Allisonville Road
Suite 330
Indianapolis, IN 46250
Phone: (317) 595.1000
Fax: (317) 572.1236

**BLOOMINGTON PLAN COMMISSION
STAFF REPORT**

Location: 4500 E Third Street

CASE #: SP-40-21

DATE: December 13, 2021

PETITIONER: Strauser Construction Co
453 S Clarizz Blvd.
Bloomington, IN 47401

CONSULTANT: Smith Design Group, Inc.
2755 E Canada Dr., Suite 101
Bloomington, IN 47401

REQUEST: The petitioner is requesting major site plan review for a new 105-unit mixed-use development in the Mixed-Use Student Housing (MS) zoning district.

BACKGROUND:

Area:	1.42 acres
Current Zoning:	Mixed-Use Student Housing (MS)
Comprehensive Plan Designation:	Neighborhood Residential
Existing Land Use:	Dwelling, Multifamily
Proposed Land Use:	Student Housing or Dormitory
Surrounding Uses:	North – Dwelling, Multifamily
	South – Dwelling, Multifamily
	East – Memorial Stadium/Indiana University
	West – Dwelling, Multifamily

REPORT: The property is currently zoned Mixed-Use Student Housing (MS) and located at the northwest corner of E 19th Street and N Dunn Street. The properties to the north, south, and west are also zoned MS. The property to the east is zoned Mixed-Use Institutional (MI). The property fronts along E. 19th Street and N Dunn Street. The site spans several parcels and is currently developed with a mix of single-family, fourplex, and multifamily structures for a total of 33 dwelling units currently existing.

The petitioner is requesting major site plan approval for a new 105-unit mixed-use development with ground floor commercial space. The residential portion of this development will consist of one-, two-, three, and four-bedroom apartments for a total of 255 beds. The commercial component will consist of 2,865 square feet of commercial space. The presence of four-bedroom units classifies this use as “student housing or dormitory.” The proposed development is 6 stories, or approximately 55’-7” measured from the average finished grade, with a maximum spot height of 66’-8” and contains 195,083 square feet of gross floor area.

In the MS zoning district, student housing or dormitory uses have a maximum building floor plate size of 20,000 square feet. However, if either affordable housing or sustainable development incentives are utilized, then there shall be no maximum building floor plate. The petitioners are proposing to utilize the sustainable development incentives so the maximum building floorplate does not apply. They are proposing to incorporate light colored hardscaping, solar power, cool roof, and covered parking to achieve at least four of the six qualifying criteria.

MAJOR SITE PLAN REVIEW 20.06.050(a)(2)(C)(ii): Major site plan approval is required for developments that contain more than 50 dwelling units and developments that contain more than 15,000 square feet of gross floor area. This proposed site plan will create 105 dwelling units with roughly 195,083 square feet of gross floor area.

DEVELOPMENT STANDARDS & INCENTIVES 20.04: The following UDO standards are required to be reviewed for all activities that require New Development approval.

Dimensional Standards:

- **Setbacks:** The MS zoning district requires a 15' front, side, and rear setback. The proposed site plan demonstrates compliance with setbacks.
- **Height:** The maximum height in the MS zoning district is 6 stories not to exceed 75' at average finished grade. Each proposed building in this development is 6 stories and 55'-7" from average finished grade with a maximum spot height of 66'-8".
- **Impervious Surface Coverage:** The maximum impervious surface coverage in the MS zoning district is 70%. The impervious surface coverage for this development is approximately, but does not exceed 70%.

Environmental: There are no known environmental constraints on the site. The petitioner is proposing to use sustainable building incentives. A copy of the Environmental Commission's memo is included in the packet.

Bicycle Parking/Alternative Transportation: Residential uses in the MS zoning district are required to provide bicycle parking spaces at 10% of the provided vehicle parking or 1 space per 5 bedrooms, whichever is more. Developments with both nonresidential and residential uses shall provide the cumulative required number of bicycle parking spaces as calculated for the respective nonresidential and residential requirements. A total of 63 bicycle parking spaces will be required. They are proposing 77 bicycle parking spaces throughout the site.

This development will also improve the pedestrian facilities along N Dunn Street and E 19th Street. Per the Transportation Plan's requirements, a 6' wide sidewalk and tree plot is required along E 19th Street and a 5' tree plot and 10' multiuse path is required along N Dunn Street. The site plan shows both of these requirements.

Landscaping: A minimum of one canopy tree shall be planted per 40 feet of property that abuts a public right-of-way. The proposed site plan meets this requirement of 3 street trees along Dunn Street and 13 street trees along 19th Street. The City's Urban Forester will need to be consulted about the species of street trees which can be utilized with this development. A compliant landscape plan for the interior of the site including parking areas, as well as the street trees, is required before a grading permit will be issued. A condition has been added.

Access: This proposed development will derive access from two driveway access points along 19th Street. Both driveways will lead to the 2-story parking garage. Both driveways meet the required separation requirements from the adjacent driveway and intersection.

Parking: The minimum vehicle parking requirement for a student housing or dormitory use is .5 spaces per bedroom. This would give them a minimum parking requirement of 127.5 parking spaces. The maximum vehicle parking allowance for student housing or dormitory uses is .75

parking spaces per bedroom, giving them a maximum parking allowance of 191.25 parking spaces. They are proposing 140 vehicle parking spaces.

Architecture: The structure will be finished with a mix of masonry veneer, fiber cement siding, and metal panel cladding which are permitted materials in this district. The exterior façade of the building incorporates wall elevation projections, a regular pattern of glass on the first floor, and changes in façade height to comply with the patterns requirements of the UDO. The flat roof features parapets on the supporting walls to meet the roof design requirements.

Sustainable Development Incentives: The petitioner is proposing to utilize the following sustainable development incentives:

1. Solar power
2. Light colored hardscape
3. Cool roof
4. Covered vehicle parking

In order to be eligible for the sustainable development incentives, the UDO requires that the petitioner meet one of two options under section 20.04.110(d)(2). The petitioners have chosen option one by incorporating four of the six qualifying criteria into their development. The petitioner will be required to provide more details on their sustainable development practices prior to the issuance of a grading permit. A condition of approval has been added.

SITE PLAN REVIEW: The Plan Commission shall review the major site plan petition and approve, approve with conditions, or deny the petition in accordance with Section 20.06.040(g) (Review and Decision), based on the general approval criteria in Section 20.06.040(d)(6)(B) (General Compliance Criteria).

20.06.040(d)(6)(B) General Compliance Criteria

- i. Compliance with this UDO
- ii. Compliance with Other Applicable Regulations
- iii. Compliance with Utility, Service, and Improvement Standards
- iv. Compliance with Prior Approvals

PROPOSED FINDINGS:

This development will meet all applicable standards in the UDO. The proposed development will utilize sustainable development incentives to be exempt from the maximum building floor plate requirement. This development is in compliance with city regulations including utility, service, and improvement standards. This development is in compliance with other applicable regulations. No relevant prior approvals are found with this petition.

CONCLUSION: This petition meets all requirements of the UDO and will add 105 new dwelling units near other high-density uses and amenities. The development will provide student housing in an area where student housing is common and is immediately adjacent to the Indiana University campus. The scale of this development is appropriate for the neighborhood. Given other recent developments and proximity to Indiana University, this is an ideal location for this type of land use.

RECOMMENDATION: The Planning and Transportation Department recommends that the Plan Commission adopt the proposed findings and approve SP-40-21 with the following conditions:

1. The petitioner must receive a grading permit before earth moving.
2. The petitioner will provide specific details of their sustainable development incentives prior to the issuance of a grading permit. Planning and Transportation will verify installation prior to the issuance of occupancy.
3. A landscape plan that meets all UDO requirements, including required street trees, must be submitted and approved prior to issuance of a grading permit.



City of Bloomington
Bloomington Environmental Commission

MEMORANDUM

Date: December 13, 2021
To: Bloomington Plan Commission
From: Bloomington Environmental Commission
Subject: SP-40-21: University Properties IX, LLC
19th and Dunn Streets

The purpose of this memo and all Environmental Commission (EC) memos involving the Plan Commission and new development in Bloomington, is to convey the environmental concerns and subsequent recommendations for conditions of approval. The Environmental Commission's objective is that the results of our review and suggestions will lead to enhancement of the ecosystem services provided, and the climate-change mitigation attributes of the site.

Comments

1.) The Petitioner's Statement shows there will be green building features used for this project. The Environmental Commission would like to know the specifications ---values and quantities--- for these features. For example, what reflectance value will the "light-colored" hardscaping be? Is it simply concrete compared to asphalt; or is it something better? What type of cool roof is being designed?

Recommended Conditions of Approval

1.) Provide specifications for the green building features.

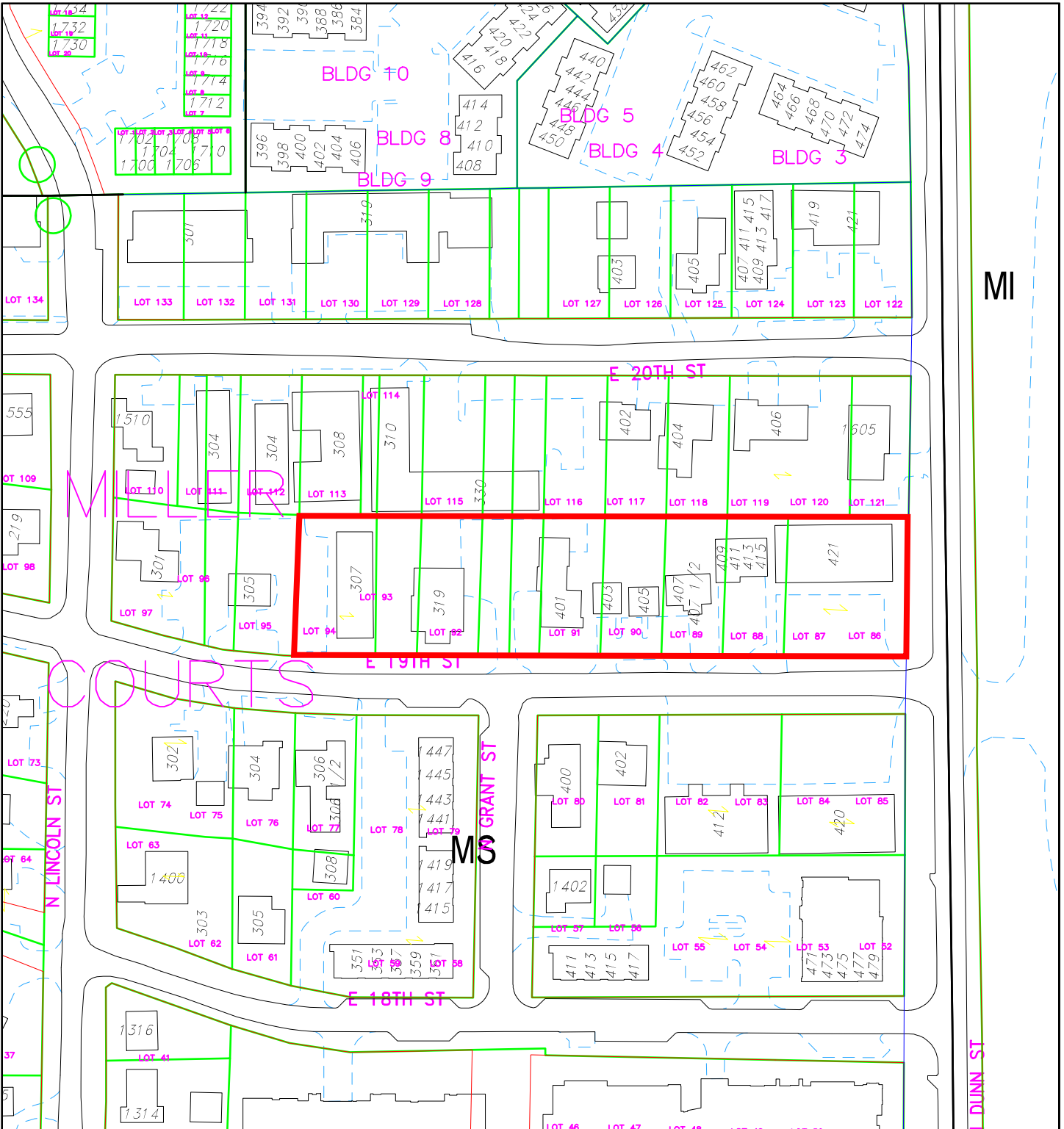

MI

City of Bloomington
Planning

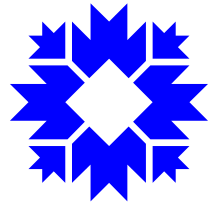

By: keegan.gulick
1 Nov 21

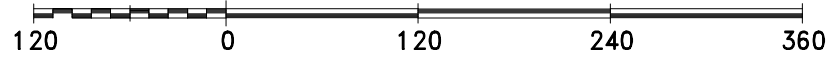

Scale: 1" = 120'

For reference only; map information NOT warranted.

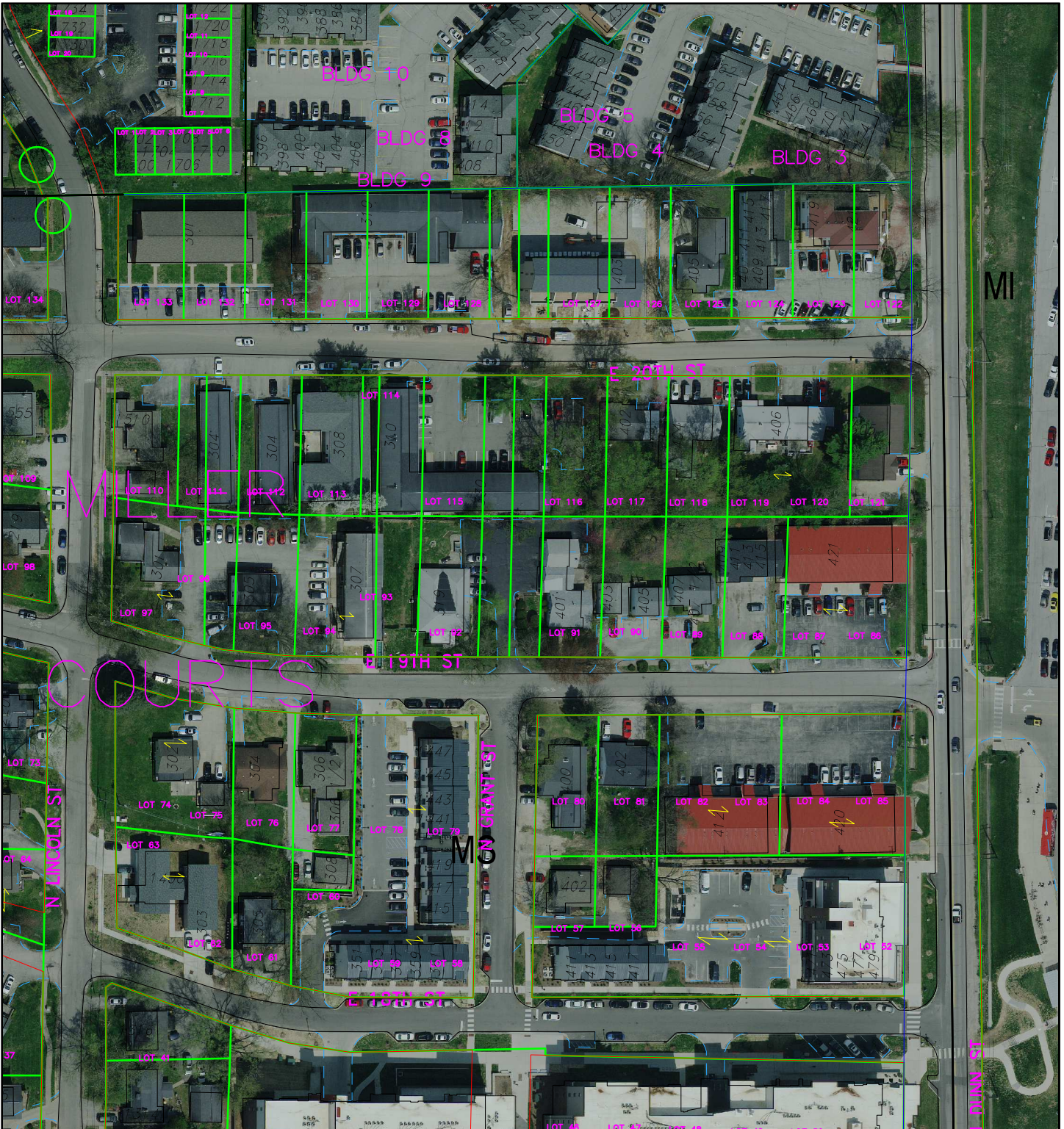

City of Bloomington
Planning

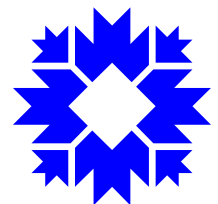

Scale: 1" = 120'

By: keegan.gulick

1 Nov 21

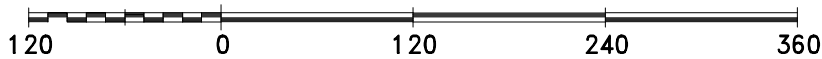

For reference only; map information NOT warranted.



Todd M. Borgman, P.L.S.

Katherine E. Stein, P.E.

Don J. Kocarek, R.L.A.

Stephen L. Smith, Founder

November 8, 2021

City of Bloomington Plan Commission
City of Bloomington Planning & Transportation Department
Showers Building Suite 130
401 N Morton St
Bloomington, Indiana 47404

Dear Keegan and Members of the Plan Commission,

For your consideration, University Properties IX, LLC is submitting to you this petition for Major Site Plan Approval for a 1.42 acre property located at 307, 319, 401, 403, 405, 407, 409, and 421 E 19th St. The site is zoned Mixed-Use Student Housing (MS).

The surrounding properties consist of a mix of single-family residential and multi-family residential uses. Directly east of the property is an institutional use – IU Memorial Stadium. The site is currently fully developed and there are no known environmental issues on site. There are eight existing buildings on site: an eight-unit multifamily residential building currently known as “Hoosier Station”, five single-family residences, a four-unit multifamily residential building, and a sixteen-unit multifamily residential building. Altogether there are a total of 33 residential dwelling units currently on site. There are currently six driveways off of E 19th St and approximately 45 off-street parking spaces serving the various properties.

The proposed project consists of the demolition of the eight existing buildings on site and the associated surface parking areas. A five-to-six-story mixed-use multifamily residential and commercial building is proposed. The residential component will consist of a mix of one-, two-, three-, and four-bedroom apartments totaling 105 units and 255 beds. There will also be residential amenity areas for residents including an indoor pool, sauna, community room, movie theatre, and study spaces. Ground-level residential units will be accessed directly from the street to help provide a more residential streetscape feel. The commercial component will consist of two retail spaces totaling 2,865 SF of leasable space. A two-story parking garage with 140 vehicle parking spaces and 39 bicycle parking spaces will also be provided.

Per the city’s 2019 Transportation Plan guidance the street frontage along E 19th St will be improved to have a 6 foot wide street tree plot and a 6 foot wide sidewalk. The street frontage along N Dunn St will be improved to have a 5 foot wide street tree plot and a 10 foot wide multi-use path. The existing six driveways will be reduced to two driveways: a shared driveway with the 19th and Lincoln Apartments project and a lower level parking garage access drive. The existing



Todd M. Borgman, P.L.S.

Katherine E. Stein, P.E.

Don J. Kocarek, R.L.A.

Stephen L. Smith, Founder

perpendicular parking off of E 19th St will be eliminated. 39 bicycle parking spaces will be provided inside the building's parking garage and 38 bicycle parking spaces are provided near the building's entrances. The project will provide a minimum of 30% landscape area and a maximum of 70% impervious surface area as required by the UDO. Drainage from the site will be managed as required by city utilities.

The architectural design responds to the scale and character of recent development in the area, particularly the neighboring complex directly to the south, by incorporating a unique mix of materials, roof forms, and façade projections. The exterior will consist of a mixture of brick veneer, metal panel, fiber cement siding, metal railings, and canopies to help bring down the scale of the facades. Many units will contain a balcony that adds visual interest and activity along 19th & Dunn Streets. The main pedestrian entry at the SE corner of the building is highlighted by a large canopy and folding glass wall that opens to an entertainment plaza that overlooks Memorial Stadium. The basement level parking will be wrapped with a combination of brick colors and broken up with ample patios and stoops that provide direct access to the new pedestrian pathway along 19th Street. The upper level apartments contain a mix of one, two, three, and four-bedroom units with unique informal gathering spaces on each level. The development intends to incorporate several sustainable initiatives including light colored hardscaping, solar power, and cool roofs.

The desire is to begin demolition in February of 2022, construction to begin in March of 2022, and to be complete by August 2023.

Thank you for your consideration of this petition. Please feel free to reach out to me with any questions.

Regards,

A handwritten signature in blue ink, appearing to read 'Kendall Knoke', is written over a light blue horizontal line.

Kendall Knoke
Smith Design Group, Inc.
812-336-6536 Ext. 3
kknoke@smithdginc.com

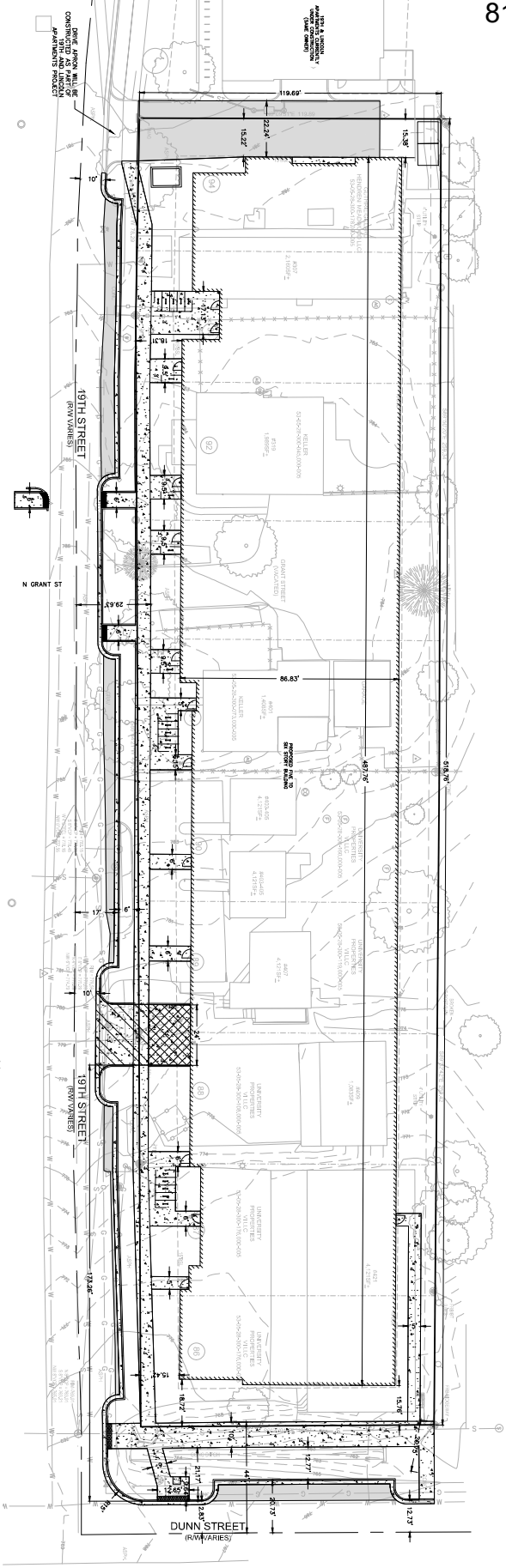

SITE PLAN LEGEND

- CONCRETE
- CONCRETE DRIVE PAVEMENT
- CONCRETE PAVEMENT
- ASPHALT PAVEMENT

SITE PLAN NOTES

1. RESIDENTIAL UNIT REVISIONS TO BE MADE TO THE EXISTING PLAN TO ACCOMMODATE THE NEW UNIT LAYOUT AND TO BE SUBMITTED TO THE CITY OF BLOOMINGTON FOR REVIEW AND APPROVAL.
2. ALL OTHER NOTES ON THE EXISTING PLAN SHALL REMAIN IN FULL FORCE AND EFFECT UNLESS OTHERWISE NOTED.

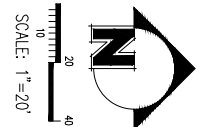

Copyright © Smith Design Group, Inc. 2020/2021. All Rights Reserved.

DATE	11/29/2021
SHEET	C200
NO. DRAWINGS	6380

REVISIONS	BY	DATE

**19TH & DUNN ST
MIXED USE BUILDING
BLOOMINGTON, INDIANA**

NOT FOR
CONSTRUCTION
XX/XX/20XX



SMITH DESIGN GROUP
CIVIL ENGINEERING LAND SURVEYING
2755 E Canada Dr Suite 101 Bloomington, IN 47401
(812) 338-6359 - smithdng.com

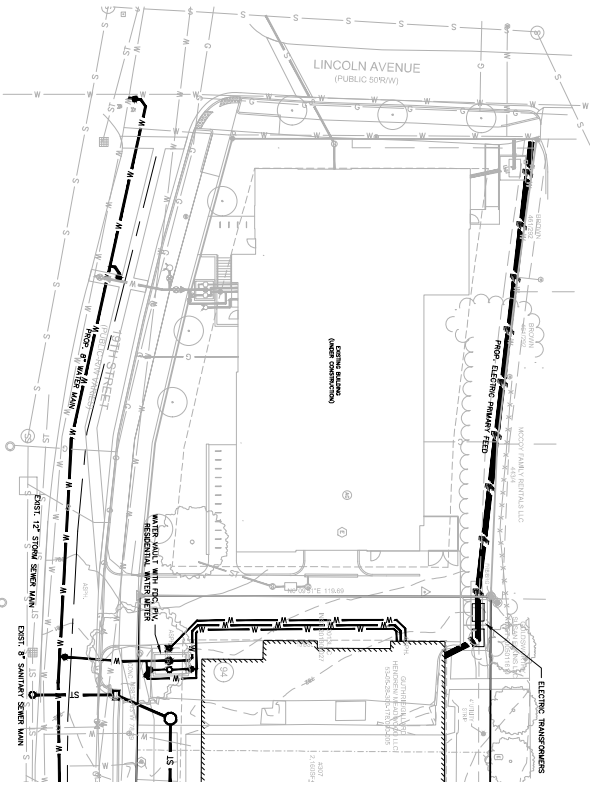
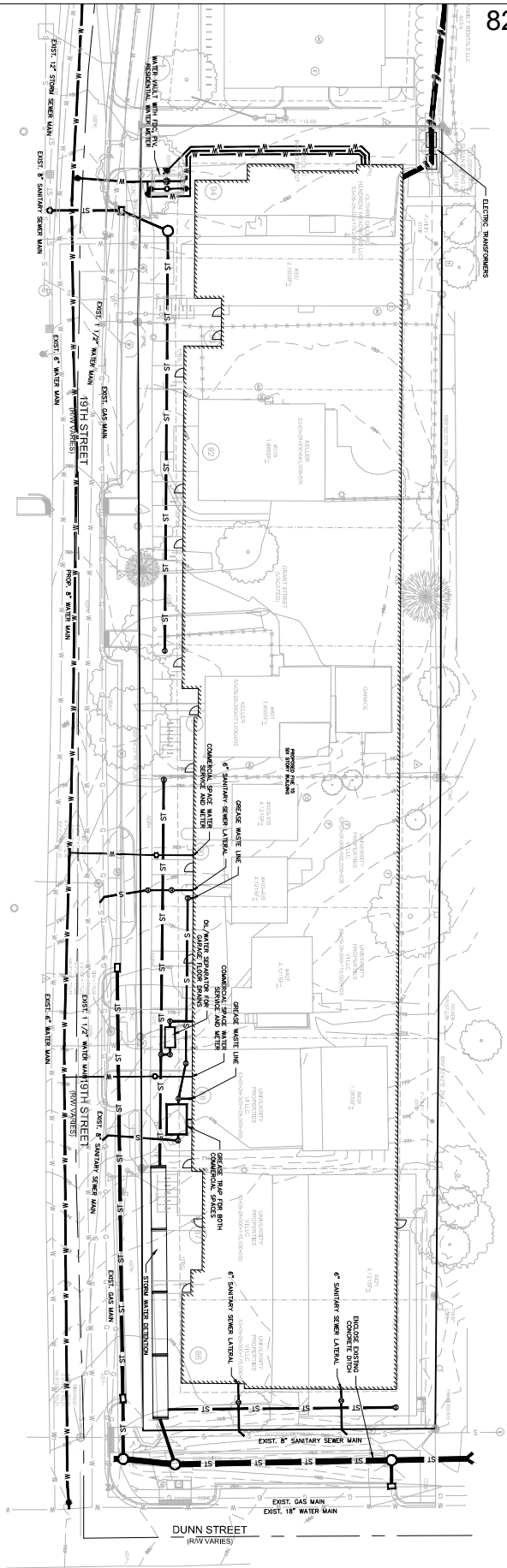

OFF SITE UTILITY PLAN

Copyright © 2021 Smith Design Group, Inc. All rights reserved.

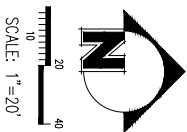

PROJECT NO.	6380
SHEET NO.	C300
DATE	11/29/2021
UTILITY PLAN	

NO.	REVISIONS	BY	DATE

**19TH & DUNN ST
MIXED USE BUILDING
BLOOMINGTON, INDIANA**

NOT FOR
CONSTRUCTION

XX/XX/20XX



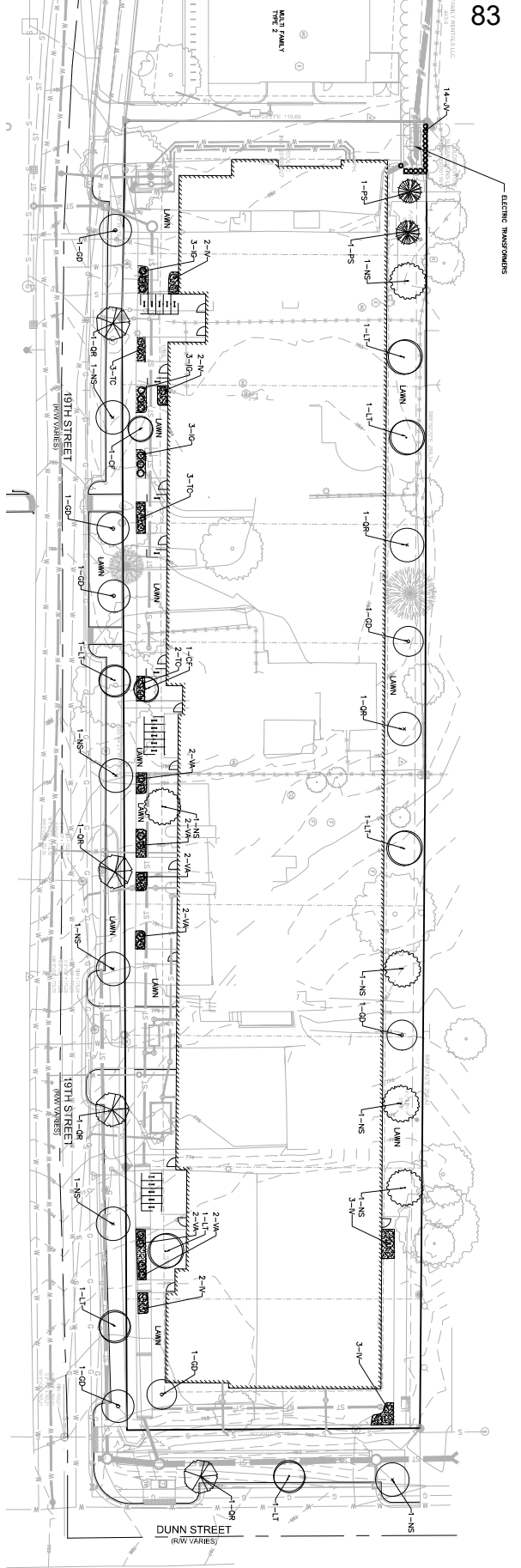

LANDSCAPE NOTES

- 1) PLANT MATERIAL SPECIFICATIONS MUST BE APPROVED IN WRITING.
- 2) ALL LANDSCAPING AND PLANTING SHALL OCCUR WITHIN A MINIMUM OF 10' OF FINISH GRADE.
- 3) SPECIFIC NOTES FOR PLANTING SHALL BE PROVIDED FOR EACH PLANTING ITEM.
- 4) LANDSCAPING SHALL BE INSTALLED AS SHOWN ON THE APPROVED PLAN.

FINISH LAWN TYPE

- 1) FINISH LAWN SHALL BE 50% OF Annual Precipitation, 50% of 1/2" of settled soil.
- 2) FINISH LAWN SHALL BE 50% OF Annual Precipitation, 50% of 1/2" of settled soil.
- 3) FINISH LAWN SHALL BE 50% OF Annual Precipitation, 50% of 1/2" of settled soil.
- 4) FINISH LAWN SHALL BE 50% OF Annual Precipitation, 50% of 1/2" of settled soil.

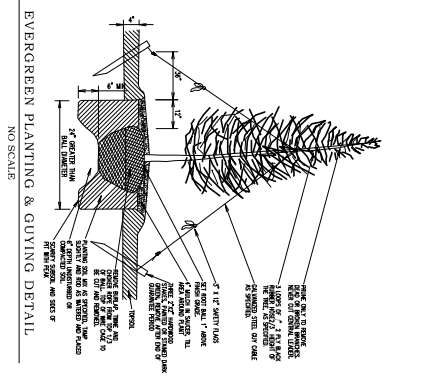
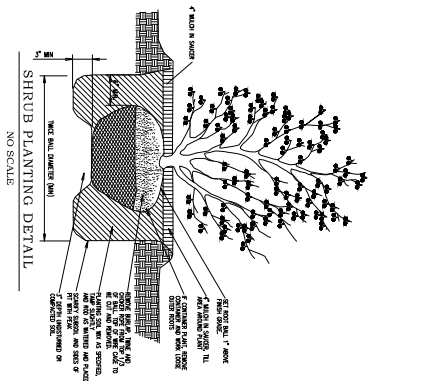
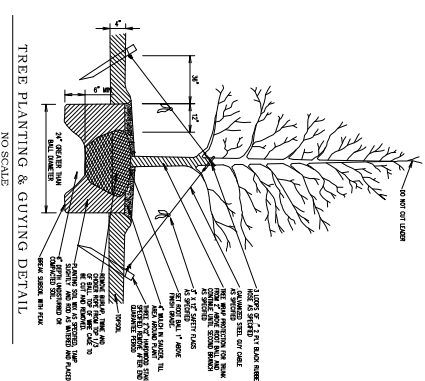

STREET TREES PLANT TABLE

ID	BOTANICAL NAME	COMMON NAME	SIZE
01	FRAXINUS	White Oak	2" Caliper
02	QUERCUS	Red Oak	2" Caliper
03	QUERCUS	White Oak	2" Caliper
04	QUERCUS	Red Oak	2" Caliper
05	QUERCUS	White Oak	2" Caliper
06	QUERCUS	Red Oak	2" Caliper

INTERIOR LANDSCAPING PLANT TABLE

ID	BOTANICAL NAME	COMMON NAME	SIZE
01	FRAXINUS	White Oak	2" Caliper
02	QUERCUS	Red Oak	2" Caliper
03	QUERCUS	White Oak	2" Caliper
04	QUERCUS	Red Oak	2" Caliper
05	QUERCUS	White Oak	2" Caliper
06	QUERCUS	Red Oak	2" Caliper

SCALE: 1"=20'

6380
SHEET
L101
DATE: 11/29/2021
LANDSCAPE PLAN

NO.	REVISIONS	BY	DATE

19TH & DUNN ST
MIXED USE BUILDING
BLOOMINGTON, INDIANA

XX/XX/20XX
NOT FOR
CONSTRUCTION

SMITH DESIGN GROUP
CIVIL ENGINEERING LAND SURVEYING
2705 E Canada Dr Suite 101 Bloomington, IN 47401
(812) 338-6359 - smithdesign.com

19TH & DUNN ST. MIXED USE BUILDING

UNIVERSITY PROPERTIES VI, LLC

NOVEMBER 20 2021
 E 19TH STREET
 ELCOMINGTON, INDIANA

PROJECT LOCATION MAP



NOT FOR CONSTRUCTION
DRC SUBMISSION - NOVEMBER 2021

OWNER

UNIVERSITY PROPERTIES VI, LLC
 2075 N. DUNN STREET
 BLOOMINGTON, INDIANA 47409

ARCHITECT

LAAR ARCHITECTURE & DESIGN
 10400 SR 662 W.
 NEWBURGH, INDIANA 47630
 812-890-2237

CIVIL ENGINEER

SMITH DESIGN GROUP
 2000 W. WASHINGTON
 BLOOMINGTON, INDIANA 47401
 812-396-8596

STRUCTURAL ENGINEER

LYNCH, HARRISON, BRUMLEVE
 550 VIRGINIA AVE.
 INDIANAPOLIS, INDIANA 46203
 317-453-1590

MEP ENGINEER

GENESIS ENGINEERING GROUP
 91 S. MAIN STREET, SUITE 200
 ZIONSVILLE, INDIANA 46077
 317-927-4307

CODE CONSULTANT

RTM CONSULTANTS, INC.
 6000 W. WASHINGTON
 INDIANAPOLIS, INDIANA 46254
 317-228-7700

CONSTRUCTION MANAGER

STRAUSSER CONSTRUCTION CO. INC.
 453 S. CLARKE BLVD.
 BLOOMINGTON, INDIANA 47401
 812-396-3995

Sheet Number	Sheet Name
GI1	CONCEPT RENDERINGS
GI2	CONCEPT RENDERINGS
GI3	CONCEPT RENDERINGS
GI4	CONCEPT RENDERINGS
GI5	CONCEPT RENDERINGS
GI6	CONCEPT RENDERINGS
GI7	CONCEPT RENDERINGS
GI8	CONCEPT RENDERINGS
GI9	CONCEPT RENDERINGS
GI10	CONCEPT RENDERINGS
GI11	CONCEPT RENDERINGS
GI12	CONCEPT RENDERINGS
GI13	CONCEPT RENDERINGS
GI14	CONCEPT RENDERINGS
GI15	CONCEPT RENDERINGS
GI16	CONCEPT RENDERINGS
GI17	CONCEPT RENDERINGS
GI18	CONCEPT RENDERINGS
GI19	CONCEPT RENDERINGS
GI20	CONCEPT RENDERINGS
GI21	CONCEPT RENDERINGS
GI22	CONCEPT RENDERINGS
GI23	CONCEPT RENDERINGS
GI24	CONCEPT RENDERINGS
GI25	CONCEPT RENDERINGS
GI26	CONCEPT RENDERINGS
GI27	CONCEPT RENDERINGS
GI28	CONCEPT RENDERINGS
GI29	CONCEPT RENDERINGS
GI30	CONCEPT RENDERINGS
GI31	CONCEPT RENDERINGS
GI32	CONCEPT RENDERINGS
GI33	CONCEPT RENDERINGS
GI34	CONCEPT RENDERINGS
GI35	CONCEPT RENDERINGS
GI36	CONCEPT RENDERINGS
GI37	CONCEPT RENDERINGS
GI38	CONCEPT RENDERINGS
GI39	CONCEPT RENDERINGS
GI40	CONCEPT RENDERINGS
GI41	CONCEPT RENDERINGS
GI42	CONCEPT RENDERINGS
GI43	CONCEPT RENDERINGS
GI44	CONCEPT RENDERINGS
GI45	CONCEPT RENDERINGS
GI46	CONCEPT RENDERINGS
GI47	CONCEPT RENDERINGS
GI48	CONCEPT RENDERINGS
GI49	CONCEPT RENDERINGS
GI50	CONCEPT RENDERINGS
GI51	CONCEPT RENDERINGS
GI52	CONCEPT RENDERINGS
GI53	CONCEPT RENDERINGS
GI54	CONCEPT RENDERINGS
GI55	CONCEPT RENDERINGS
GI56	CONCEPT RENDERINGS
GI57	CONCEPT RENDERINGS
GI58	CONCEPT RENDERINGS
GI59	CONCEPT RENDERINGS
GI60	CONCEPT RENDERINGS
GI61	CONCEPT RENDERINGS
GI62	CONCEPT RENDERINGS
GI63	CONCEPT RENDERINGS
GI64	CONCEPT RENDERINGS
GI65	CONCEPT RENDERINGS
GI66	CONCEPT RENDERINGS
GI67	CONCEPT RENDERINGS
GI68	CONCEPT RENDERINGS
GI69	CONCEPT RENDERINGS
GI70	CONCEPT RENDERINGS
GI71	CONCEPT RENDERINGS
GI72	CONCEPT RENDERINGS
GI73	CONCEPT RENDERINGS
GI74	CONCEPT RENDERINGS
GI75	CONCEPT RENDERINGS
GI76	CONCEPT RENDERINGS
GI77	CONCEPT RENDERINGS
GI78	CONCEPT RENDERINGS
GI79	CONCEPT RENDERINGS
GI80	CONCEPT RENDERINGS
GI81	CONCEPT RENDERINGS
GI82	CONCEPT RENDERINGS
GI83	CONCEPT RENDERINGS
GI84	CONCEPT RENDERINGS
GI85	CONCEPT RENDERINGS
GI86	CONCEPT RENDERINGS
GI87	CONCEPT RENDERINGS
GI88	CONCEPT RENDERINGS
GI89	CONCEPT RENDERINGS
GI90	CONCEPT RENDERINGS
GI91	CONCEPT RENDERINGS
GI92	CONCEPT RENDERINGS
GI93	CONCEPT RENDERINGS
GI94	CONCEPT RENDERINGS
GI95	CONCEPT RENDERINGS
GI96	CONCEPT RENDERINGS
GI97	CONCEPT RENDERINGS
GI98	CONCEPT RENDERINGS
GI99	CONCEPT RENDERINGS
GI100	CONCEPT RENDERINGS

Sheet Number	Sheet Name
GI1	CONCEPT RENDERINGS
GI2	CONCEPT RENDERINGS
GI3	CONCEPT RENDERINGS
GI4	CONCEPT RENDERINGS
GI5	CONCEPT RENDERINGS
GI6	CONCEPT RENDERINGS
GI7	CONCEPT RENDERINGS
GI8	CONCEPT RENDERINGS
GI9	CONCEPT RENDERINGS
GI10	CONCEPT PLANS
GI11	ELEVATIONS

PROJECT B
UNIVERSITY
PROPERTIES,
LLC

STRAUSER
DESIGN + BUILD, LLC
305 S CHASE DRIVE
ANN ARBOR, MI 48106

**HARRIS ARCHITECTURE &
LAND**
DESIGN + BUILD, LLC
1000 W LEE ST
ANN ARBOR, MI 48106

THIS CONCEPT RENDERING OF PROPOSED BLDG. IS FOR INFORMATIONAL PURPOSES ONLY. THIS CONCEPT RENDERING IS NOT TO BE USED FOR ANY OTHER PURPOSES. THE DESIGN AND CONSTRUCTION OF THIS BLDG. IS SUBJECT TO THE FINAL DESIGN AND CONSTRUCTION DOCUMENTS. THE DESIGN AND CONSTRUCTION OF THIS BLDG. IS SUBJECT TO THE FINAL DESIGN AND CONSTRUCTION DOCUMENTS. THE DESIGN AND CONSTRUCTION OF THIS BLDG. IS SUBJECT TO THE FINAL DESIGN AND CONSTRUCTION DOCUMENTS.

DATE: 2021.11.29
REVISIONS:

NOT FOR CONSTRUCTION

CONCEPT
RENDERINGS

G1.1

ON 18TH LOOKING EAST



ON 18TH LOOKING WEST



SE CORNER OF SITE



NE CORNER OF SITE



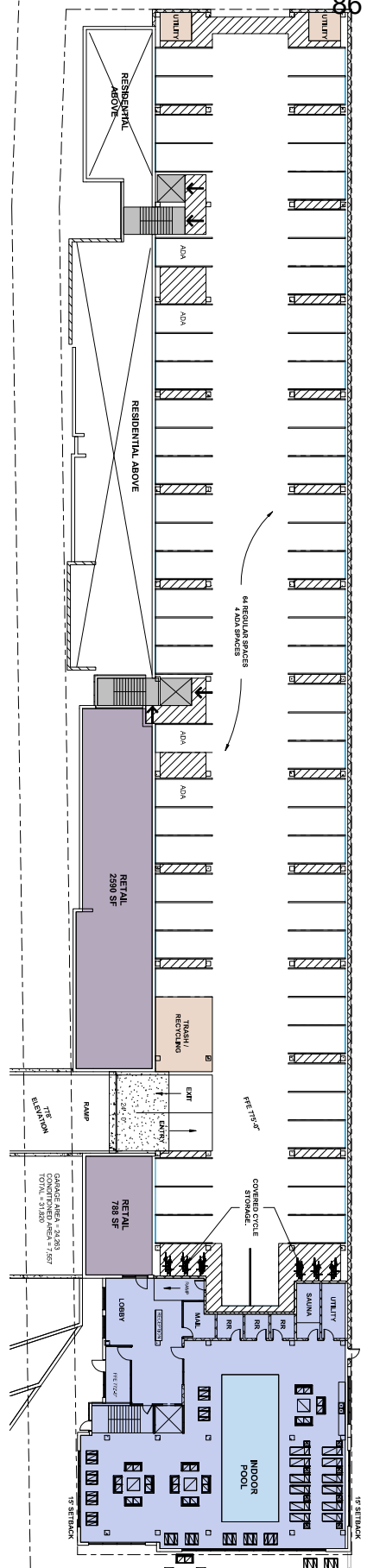

LEVEL 1 PLAN
1/16" = 1'-0"

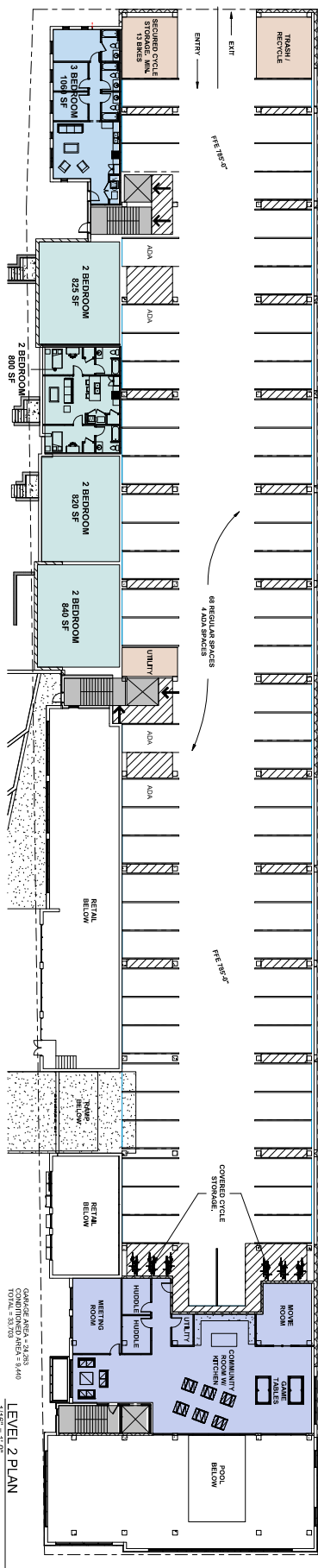

LEVEL 2 PLAN
1/16" = 1'-0"

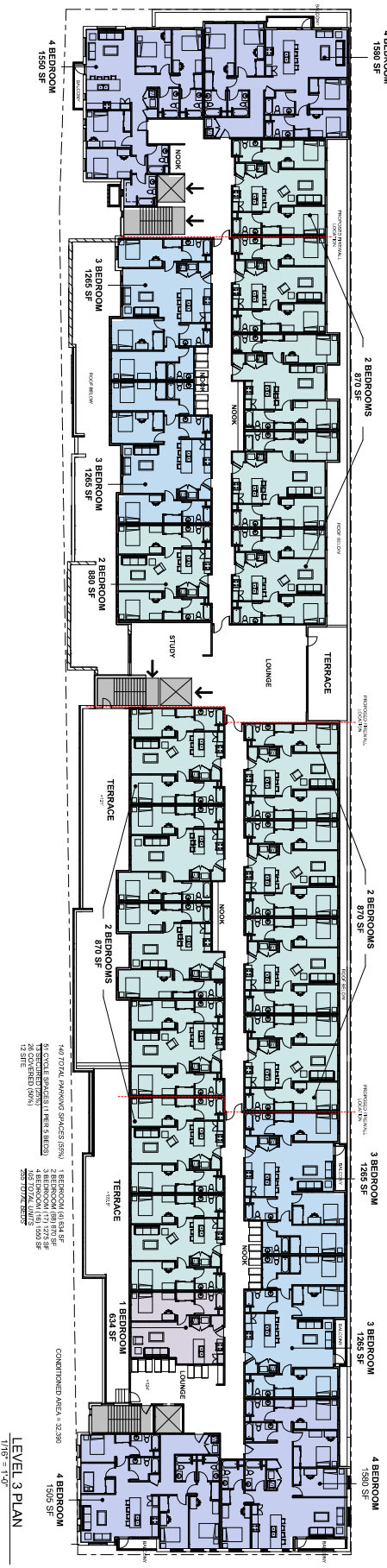

LEVEL 3 PLAN
1/16" = 1'-0"

PROJECT B
UNIVERSITY PROPERTIES, LLC

STRAUSER
DESIGN + BUILD LLC
STRAUSER DESIGN + BUILD, LLC
1033 CHASE STREET, SUITE 402
METHUEN, MA 01844

LAND: JAMES ARCHITECTURE & DESIGN, INC.
100 WASHINGTON ST., SUITE 200
METHUEN, MA 01844

DATE: 2021.11.29

REVISION:

NOT FOR CONSTRUCTION

SD1.0

CONCEPT PLANS

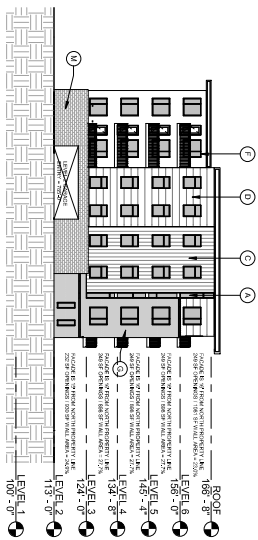

4 WEST
T=20'-0"

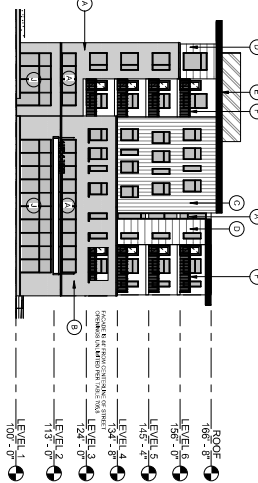

1 EAST
T=20'-0"

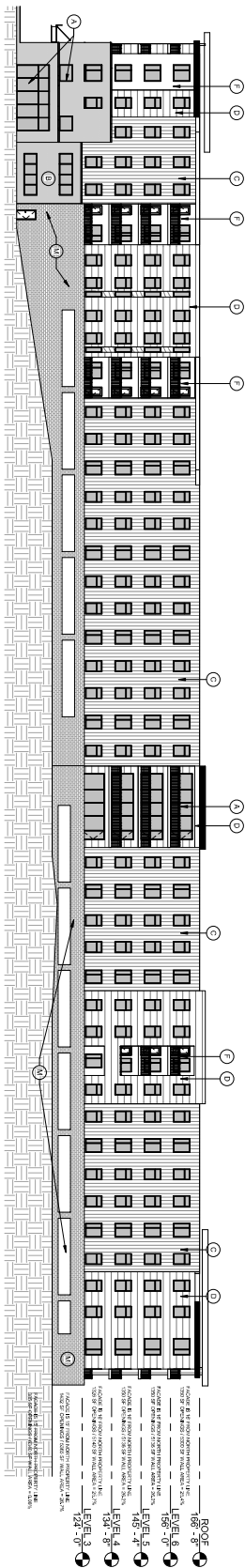

2 NORTH
T=20'-0"

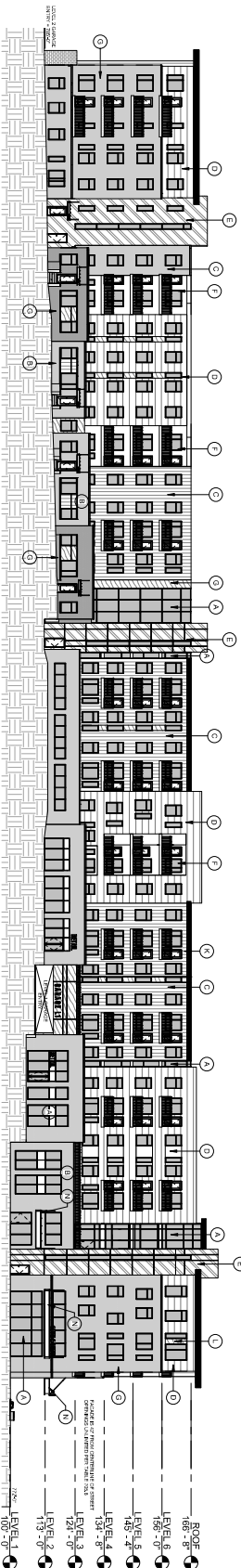

3 SOUTH
T=20'-0"

- EXTENSION REFERENCE NOTES:**
- 1 ALUMINUM STOREFRONT SYSTEM
 - 2 MASONRY VENEER #1
 - 3 FIBER CEILING SPRING TYPE #1
 - 4 METAL PANEL CLADDING TYPE A
 - 5 METAL PANEL CLADDING TYPE B
 - 6 MASONRY VENEER #2
 - 7 FINISHING CORNER OPENINGS
 - 8 FOLDING GLASS WALL ELEMENT
 - 9 METAL PANEL CLADDING TYPE C
 - 10 CONCRETE MASONRY UNIT
 - 11 SUPERHEATED METAL CANOPY

PROJECT B
UNIVERSITY PROPERTIES, LLC

STRAUSER DESIGN + BUILD, LLC
DESIGN + BUILD

LAND
KAMR ARCHITECTURE & DESIGN
MEMPHIS, TN 38102

DATE: 2021.11.29
REVISION:

NOT FOR CONSTRUCTION

ELEVATIONS

SD1.1

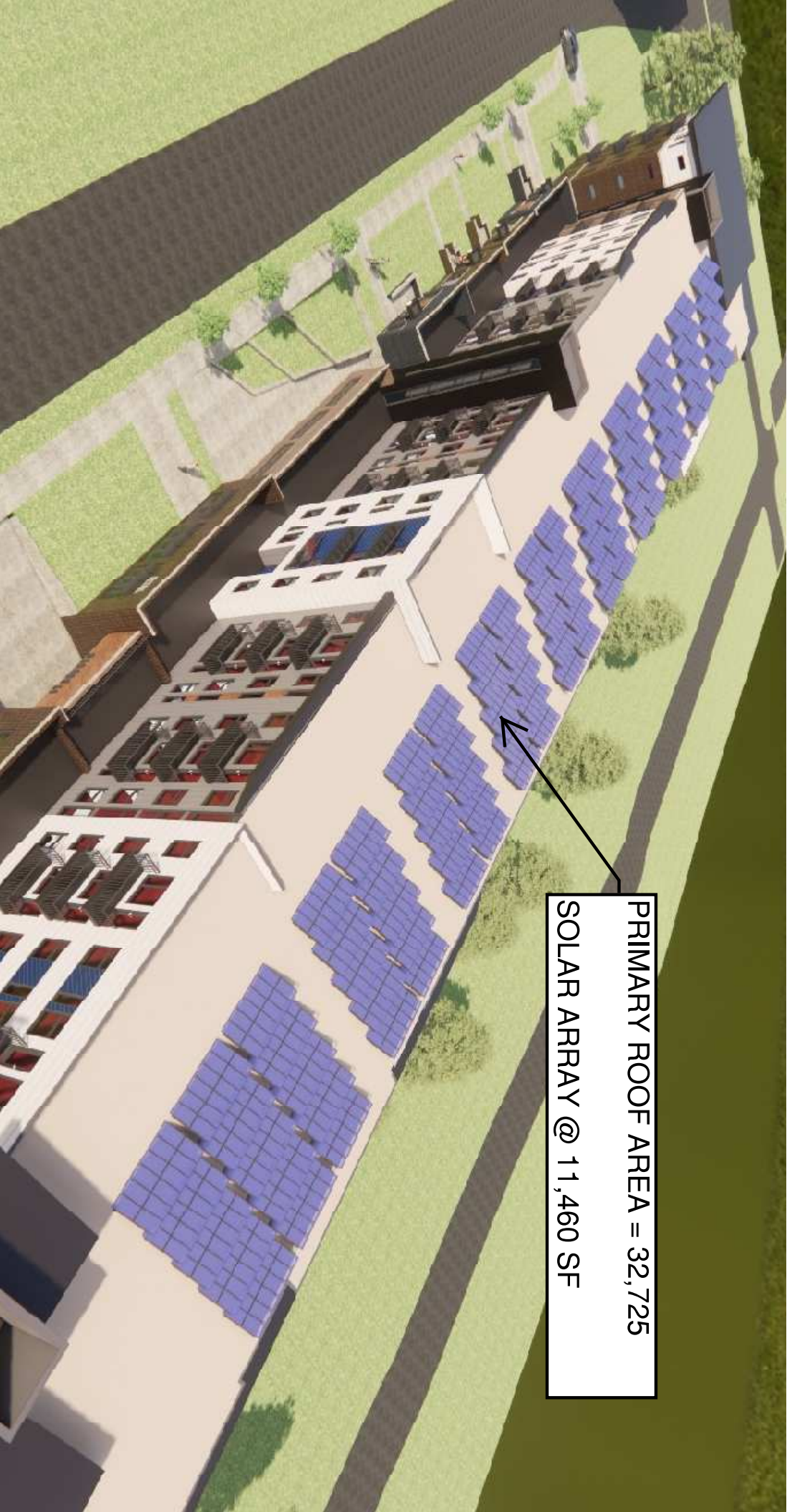

PRIMARY ROOF AREA = 32,725
SOLAR ARRAY @ 11,460 SF

EverGuard® TPO 80 mil Membrane Information Sheet

Updated: 6/18

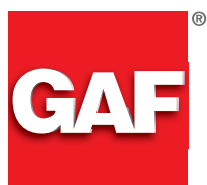

*Quality You Can Trust...From
North America's Largest Roofing Manufacturer!™*



EVERGUARD® TPO

MEMBRANE

1

2

3

80

Quality You Can
Trust...From
North America's
Largest Roofing
Manufacturer!™

gaf.com

Why TPO

- Great Value—Excellent performance at a cost-effective price
- Excellent Seam Strength—Heatwelded seams provide greater seam strength to taped and other seams
- Long-term Weathering—Excellent long-term heat and UV resistance
- Energy Saving—Highly reflective and emissive white roof can help reduce energy costs and urban heat island effect
- CREST Energy Savings Calculator—See your potential savings at cool.gaf.com
- Versatile Application Method

Why GAF EverGuard® TPO

- Outperforms standard TPO in heat aging and UV tests—the best predictors of TPO performance
 - After accelerated heat aging at 275°F (135°C) for 105 days, EverGuard® 60 mil TPO showed no cracking—while every one of the competitors' samples had failed!
 - UV testing—Greater than 2.5 times the industry standard (ASTM D6878 weather resistance test)
- Guarantees are available up to 30 years when using EverGuard® TPO 80 mil Membrane.*
- Easier to install due to:
 - Large welding window
 - Most complete line of accessories
 - 10' (3.05 m) wide sheets

Installation

EverGuard® TPO 80 mil Membrane is suitable for all types of single-ply systems:

- Mechanically Attached Application...for a quick and cost-effective system that can be installed practically year-round.



Fall River Courthouse, Fall River, Massachusetts

- RhinoBond® Application...can be applied without using adhesives and installed practically year round. Qualifies for the same guarantee length as an adhered system.*
- Adhered Application...can be installed with EverGuard® 1121 Bonding Adhesive (solvent-based), EverGuard® Low VOC Adhesive, or EverGuard® WB181 Bonding Adhesive (water-based) for the smoothest appearance. Provides excellent wind uplift performance.

Accessories

Field fabrication of TPO accessories is time-consuming, costly, and inconsistent, and can lead to unreliable details that compromise a watertight roofing system. EverGuard® TPO prefabricated accessories deliver consistent quality and eliminate the worry and problems often associated with field fabrication. They can also boost productivity up to 200%,** while reducing installed cost by up to 12%.

*See applicable guarantee for complete coverage and restrictions.

**Based on GAF estimate to field fabricate flashing details.



U.S. only



California
Title 24
Compliant



TPO membranes meet the
performance requirements
of ICC ER-6030

EverGuard® TPO 80 mil Membrane

Applicable Standards

UL Listed, FM Approved, Miami-Dade County Product Control Approved, State of Florida Approved, CRRC Rated, Title 24 Compliant*, ENERGY STAR® Certified**, ASTM D6878.

Physical Properties	ASTM Test Method	ASTM D6878 Minimum	EverGuard® Typical Test Data
1. Certain data is provided in MD (machine direction) x CMD (cross machine direction) format. 2. Data is based upon typical product performance, and is subject to normal manufacturing tolerance and variance.			
Nominal Thickness	ASTM D751	0.039" (min.) (0.99 mm)	0.080" (2.03 mm)
Breaking Strength	ASTM D751 Grab Method	220 lbf/in. (38.5 kn/m)	335 lbf x 320 lbf (499 x 477 kg/m)
Factory Seam Strength	ASTM D751	66 lbf (98.34 kg/m)	160 lbf (membrane failure) (238.4 kg/m)
Elongation at Break	ASTM D751	15%	30%
Heat Aging	ASTM D573	90% Retention of Breaking Strength and Elongation at Break	100%
Tear Strength	ASTM D751 8" x 8" (203 x 203 mm) Sample	55 lbf (81.95 kg/m)	65 lbf x 160 lbf (96.85 x 238.4 kg/m)
Puncture Resistance	FTM 101C Method 2031	Not Established	>380 lb. (172 kg)
Cold Brittleness	ASTM D2137	-40°C	-40°C
Permeance	ASTM E96	Not Established	0.08 Perms
Dimensional Change	ASTM D1204 @158°F (70°C), 6 hrs.	+/-1%	0.4%
Water Absorption	ASTM D471 @158°F (70°C), 1 week	+/-3.0%	0.7%
Hydrostatic Resistance	ASTM D751 Method D	Not Established	430 psi
Ozone Resistance	ASTM D1149	No visible deterioration @ 7 x magnification	No visible deterioration @ 7 x magnification
SRI (Solar Reflectance Index) Initial/Aged	N/A	N/A	94/81 83 Aged Title 24
Reflectivity (white) Initial/Aged	ASTM C1549 ASTM E903	N/A N/A	0.76/0.68 81.9% Reflectance
Emissivity (white) Initial/Aged	ASTM C1371 ASTM E403	N/A N/A	0.90/0.83 0.94
Weather Resistance	ASTM G155/D6878	10,080 kJ/(m ² · nm) at 340 nm	>25,000 kJ/(m ² · nm) at 340 nm
Heat Aging	ASTM D573	240°F (115°C) for 32 weeks	60 weeks
Thickness Above Scrim	ASTM D7635	Min 30% of Total Thickness	31.4 mil (Nominal)
Guarantee			
Up to 30 years			

*White Membrane Only

**ENERGY STAR® only valid in the U.S.

Product Data

Roll Size	5' x 100'	6' x 100'	8' x 100'	10' x 100'	12' x 100'
	(1.52 x 30.5 m) (500 sq. ft. [46.5 sq.m])	(1.83 x 30.5 m) (600 sq. ft. [55.74 sq.m])	(2.44 x 30.5 m) (800 sq. ft. [74.3 sq.m])	(3.05 x 30.5 m) (1,000 sq. ft. [92.9 sq.m])	(3.65 x 30.5 m) (1,200 sq. ft. [111.484 sq.m])
Roll Weight	210 lb. (95.3 kg)	252 lb. (114.3 kg)	336 lb. (152.4 kg)	420 lb. (190.5 kg)	504 lb. (228.6 kg)
Colors	White, Tan, Gray				
Storage	Store rolls on their sides on pallets or shelving in a dry area.				
Safety Warning	Membrane rolls are heavy. Position and install by at least two people.				
Note:	Membrane rolls shipped horizontally on pallets, stacked pyramid-style and banded. Product sizes, dimensions, and widths are nominal values and are subject to normal manufacturing/packaging tolerance and variation.				

RhinoBond® is a registered trademark of OMG.



Quality You Can Trust...
From North America's
Largest Roofing Manufacturer!™

gaf.com