



PRECAST SOLUTIONS, INC.
6145 S. INDIANAPOLIS ROAD
WHITESTOWN, IN 46075
317-545-6557



1500 GALLON COMMERCIAL
OIL / SEDIMENT / SILT INTERCEPTOR
H2O LOAD BEARING- DEEP BURIAL
CITY OF BLOOMINGTON UTILITIES SPECIFICATION



Copyright 2019©
Precast Solutions, Inc.
Details may only be used
with written permission.

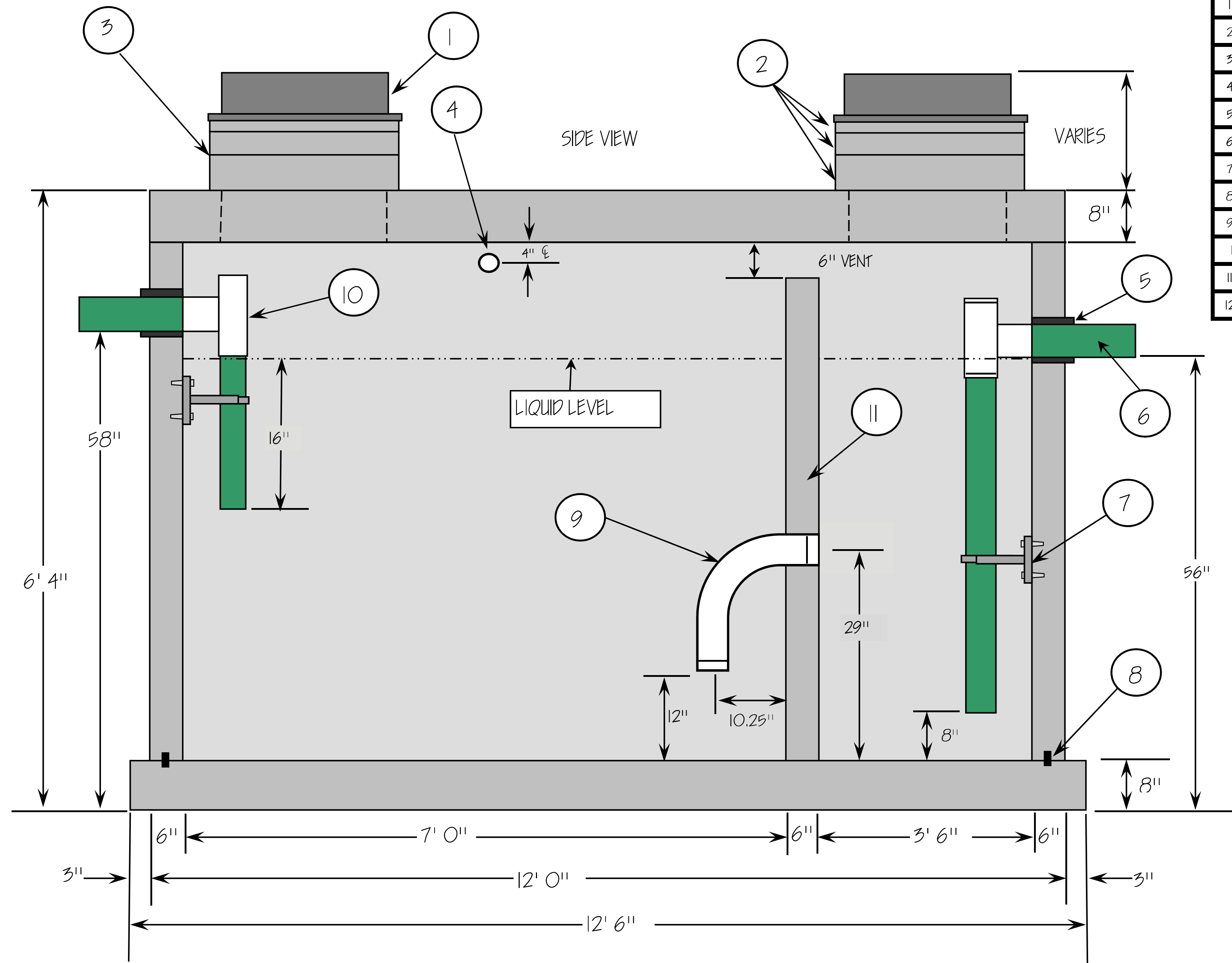

#	QTY	ITEM DESCRIPTION
1	1	EJIO20- FRAMES W/ GREASE LIDS
2	VAR	PRECAST CONCRETE GRADE RINGS
3	VAR	1/2" BUTYL MASTIC SEALANT
4	1	2" CAST-A-SEAL GASKET FOR VENT LINE
5	2	6" CAST-A-SEAL GASKET
6	2	6" SCH35 PVC PIPE
7	2	6" 304 SS PIPE BRACKET & ANCHORS
8	VAR	WATERSTOP-CETCO RX-102, CONSEAL CS231 OR EQUAL
9	1	6" SCH40 LONG SWEEP 90
10	2	6" SCH35 TEE
11	1	IPANEX WATERPROOFING CONCRETE ADMIXTURE
12	1	EXTERIOR WATERPROOF COATING-25-30 MILS

NOT TO SCALE

STRUCTURE LID #7,128
STRUCTURE BASE #22,669

PS162819-1500-BLOOM



PRECAST SOLUTIONS, INC.
6145 S. INDIANAPOLIS ROAD
WHITESTOWN, IN 46075
317-545-6557



1500 GALLON COMMERCIAL
OIL / SEDIMENT / SILT INTERCEPTOR
H2O LOAD BEARING- DEEP BURIAL
CITY OF BLOOMINGTON UTILITIES SPECIFICATION



Copyright 2019©
Precast Solutions, Inc.
Details may only be used
with written permission.

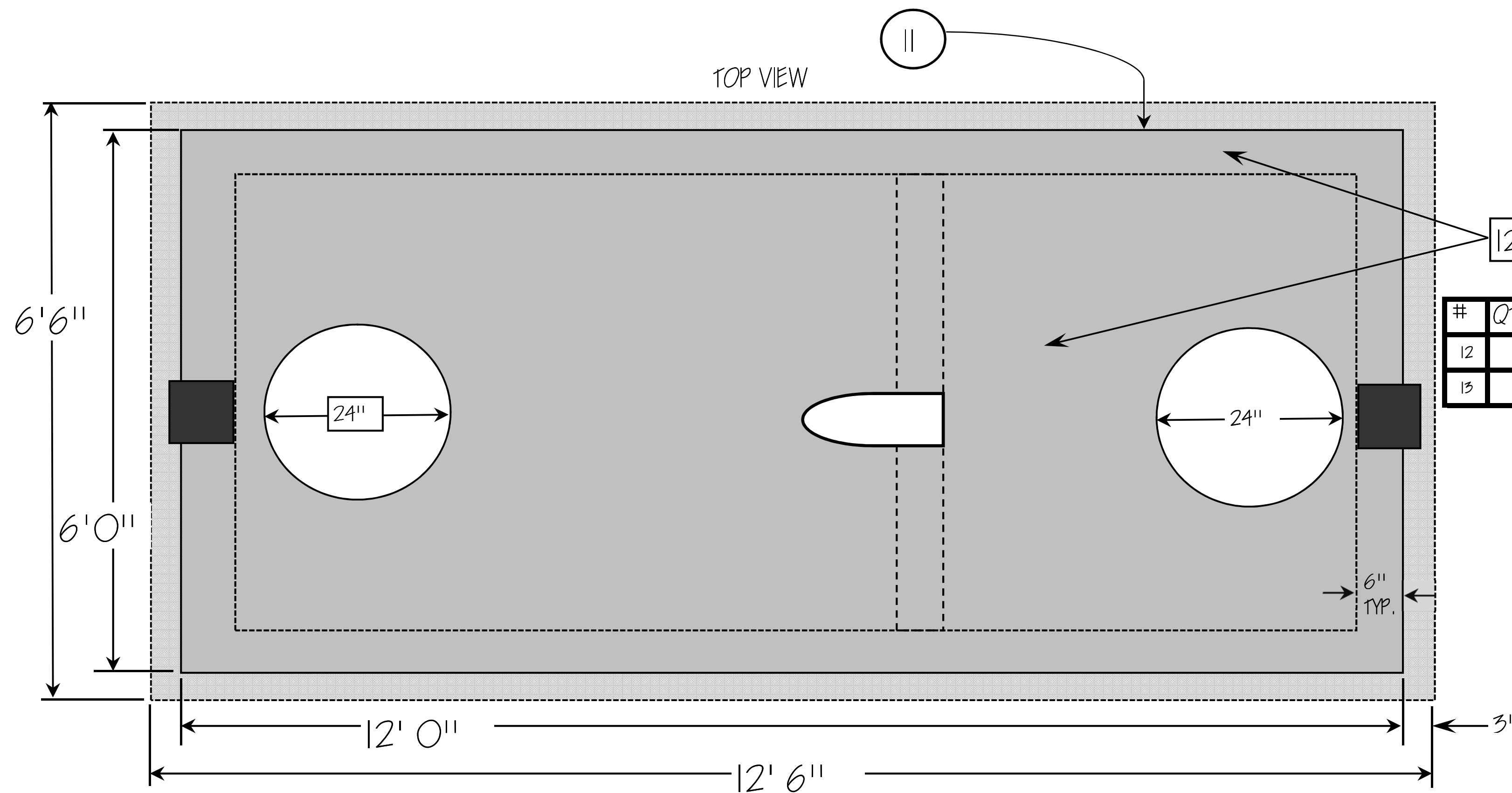

#	QTY	ITEM DESCRIPTION
12	1	IPANEX WATERPROOFING CONCRETE ADMIXTURE
13	1	EXTERIOR WATERPROOF COATING 25-30 MILS

STANDARDS OF DESIGN

- A) CONCRETE MINIMUM COMPRESSIVE STRENGTH
F'c= 5,000 PSI @ 28 DAYS.
- B) REINFORCING STEEL: ASTM A615, Fy= 60,000 PSI.
- C) DESIGN SPECIFICATIONS: ACI 318.
- D) DESIGN LOADING: H-20 TRAFFIC RATED.
- E) IPANEX, CRYSTAL-X OR AN APPROVED CONCRETE ADMIXTURE SHALL BE USED.
- F) 6" THICK SIDE WALLS.
- G) 8" THICK TOP AND BOTTOM SLAB.
- H) VAULT CASTING JOINTS SHALL BE CONSTRUCTED WITH AN APPROVED TYPE WATERSTOP.

MINIMUMS REQUIRED:

- A) IN WALLS #4 REBAR - NO WIRE MESH TO BE USED.
- B) IN TOP AND BOTTOM SLAB- #5 REBAR- 2 MATS- NO WIRE MESH TO BE USED
- C) ENGINEERED FOR 5' 0" COVER.
- D) WATERPROOF, NON-SHRINK MORTAR SHALL BE USED TO COMPLETELY SEAL AROUND INTERCEPTOR COMPONENTS THAT PENETRATE THE VAULT WALL, INCLUDING ANCHOR BOLTS, VENT LINE AND PIPING.
- E) VAULT CASTING JOINTS SHALL BE CONSTRUCTED WITH AN APPROVED WATERSTOP.
- F) ALL PIPES MINIMUM 6" DIAMETER PVC.
- G) CASTINGS AND LIDS SHALL BE EJIW 1020 SERIES OR EQUIVALENT, NON BOLT-DOWN AND LABELED GREASE.
- F) INLET PIPE INVERT SHALL BE A MINIMUM OF 2" HIGHER THAN THE OUTLET INVERT.
- H) PIPE TO VAULT CONNECTIONS SHALL BE CAST FLEXIBLE BOOT CONNECTOR (CAST-A-SEAL 402) OR CAST IN PLACE GASKET.

NOT TO SCALE

STRUCTURE LID #7,128
STRUCTURE BASE #22,669

PS162819-1500-BLOOM-2