

CITY OF BLOOMINGTON

W 6TH STREET & S ELM STREET SIDEWALK REPLACEMENT

Project Description:
 Sidewalk replacement along both sides of W. 6th St. beginning at N. Elm St. and ending at N. Fairview St.
 Sidewalk replacement along the east side of S. Elm St. beginning at W. Kirkwood Ave. and ending at W. 4th St.

GROSS LENGTH: 0.30 Miles
 NET LENGTH: 0.30 Miles



BEGIN PROJECT W 6TH ST
 LATITUDE: 39° 10' 03.49" N
 LONGITUDE: 86° 32' 43.04" W

BEGIN PROJECT S ELM ST
 LATITUDE: 39° 09' 59.88" N
 LONGITUDE: 86° 32' 43.11" W

END PROJECT S ELM ST
 LATITUDE: 39° 09' 56.57" N
 LONGITUDE: 86° 32' 43.14" W

LOCATION:
 LATITUDE: 39° 10' 03.47" N
 LONGITUDE: 86° 32' 35.17" W

R. 1W



LOCATION MAP
 BLOOMINGTON TWP.
 MONROE COUNTY

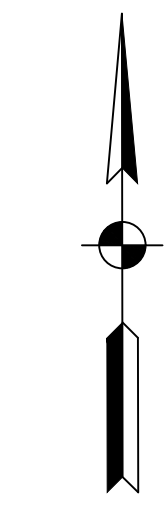

1" = 150'

END PROJECT W 6TH ST
 LATITUDE: 39° 10' 03.45" N
 LONGITUDE: 86° 32' 27.30" W

[INDIANA DEPARTMENT OF TRANSPORTATION
 STANDARD SPECIFICATIONS DATED 2020 TO
 BE USED WITH THESE PLANS]

DIRECTORY: ...\\201818-4002_Bloomington On-Call\30 SheetDrawings\6th St. Sidewalks - N Elm to N Fairview Streets\
 FILE: ...4002 TITLE.dwg
 PLOTTED BY: JShegall
 DATE: ...Nov 18, 2020 - 4:24pm

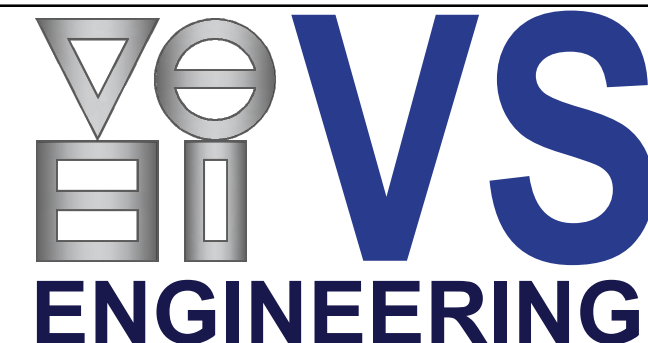

PLANS PREPARED BY:	VS ENGINEERING, INC.	TEL: (812) 332-5944
CERTIFIED BY:		PHONE NUMBER
APPROVED FOR LETTING:	Joshua T. Eisenhauer, P.E.	INDIANA REG. NO. 11600592
		DATE 11/18/2020
	INDIANA DEPARTMENT OF TRANSPORTATION	DATE

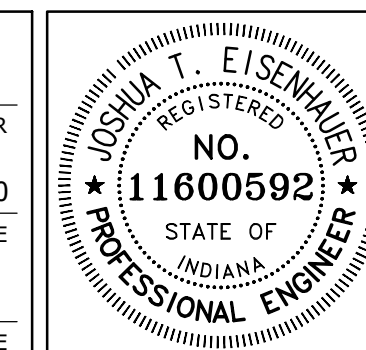

DESIGNATION	
SHEETS	1 of 7
PROJECT	18-4002
CONTRACT	

DIRECTORY: F:\2018\18-4002 Bloomington On-Call\30 SheetDrawings\6th St Sidewalks - N Elm to N Fairview Streets\
 FILE: 18-4002 TYP SEC.dwg
 DIMSCALE: 1/4" = 1'-0"
 PLOTTED BY: TSegall
 DATE: Nov 18, 2020 - 4:37pm

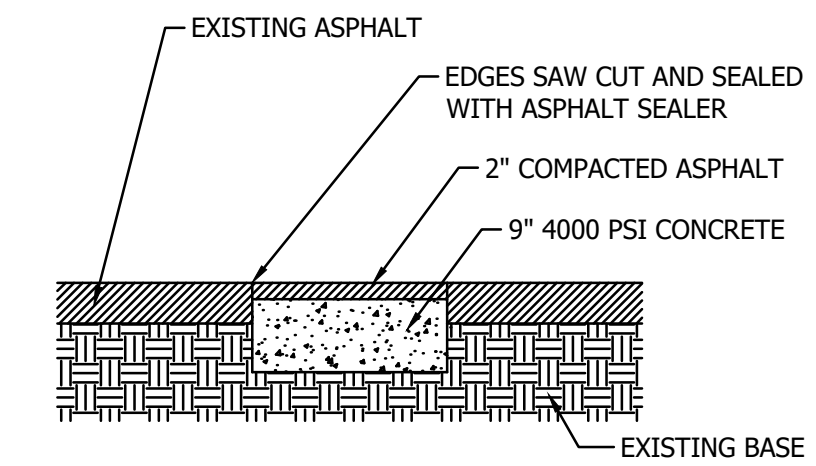
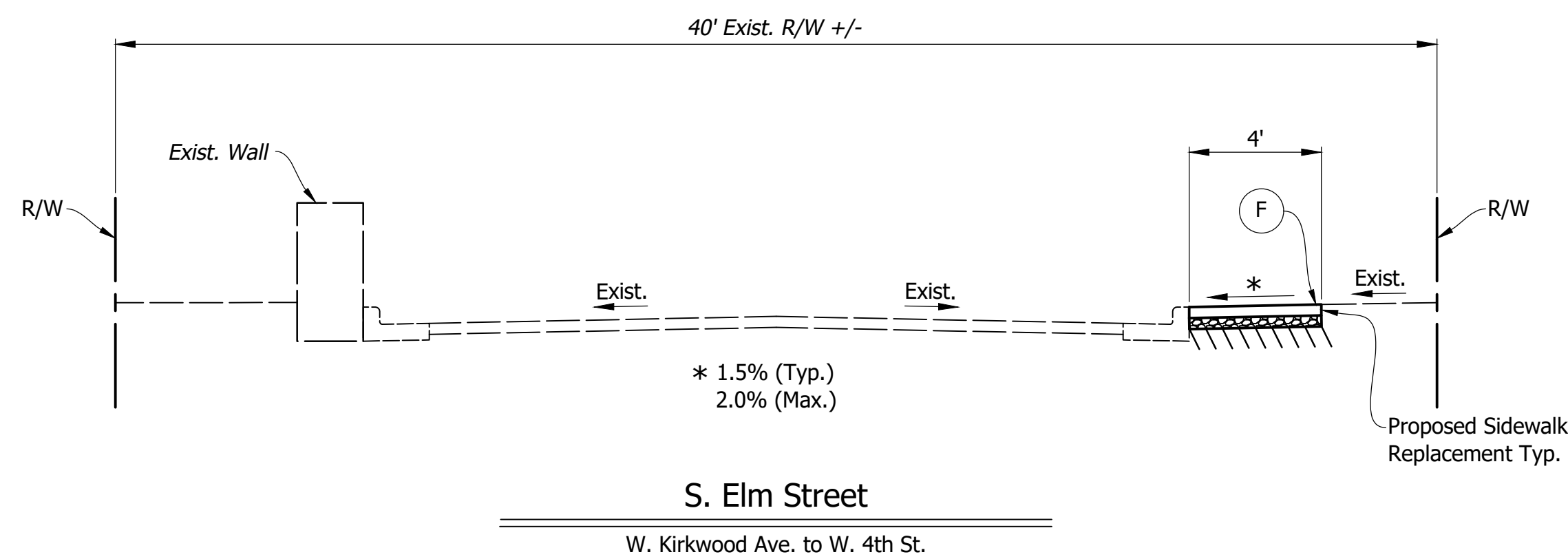
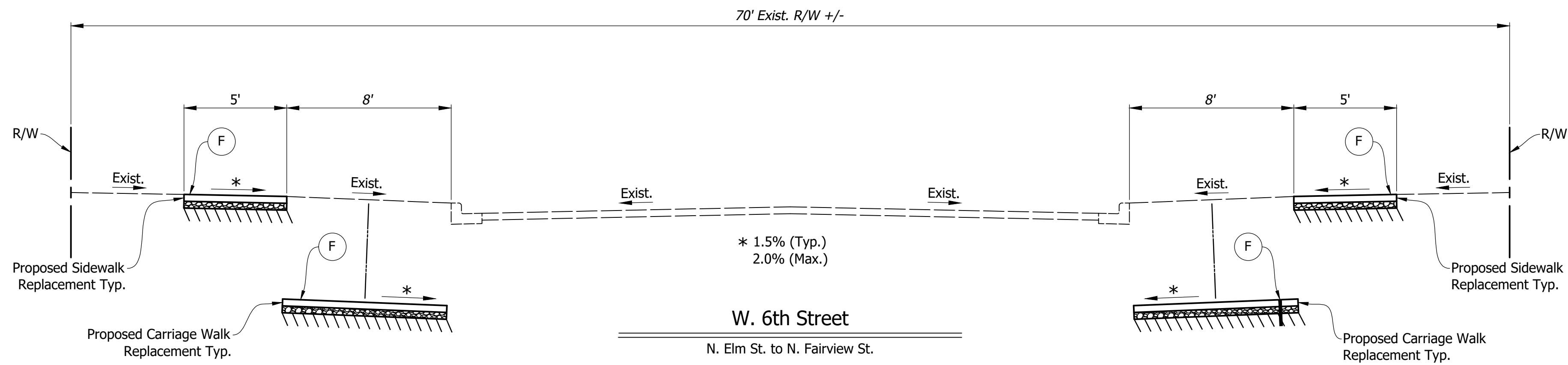

ASPHALT PATCHING DETAIL
Scale: 1/4" = 1'-0"

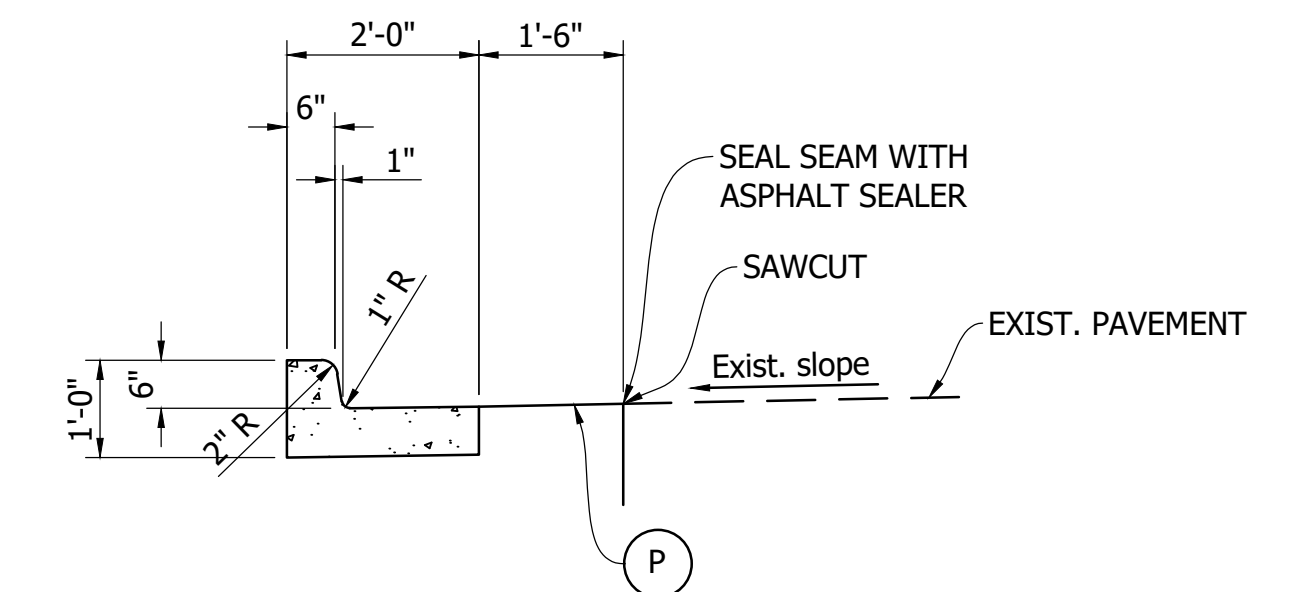

CONCRETE CURB & GUTTER
S. Elm St.
Scale: 1/2" = 1'-0"

Reference:
For Driveway Approaches See INDOT Standard Drawing No. E 610-DRIV-02

LEGEND

- (F) Sidewalk, 4" Concrete on 4" Aggregate #53's, on Compacted Subgrade
- (P) HMA for Patching, Type C

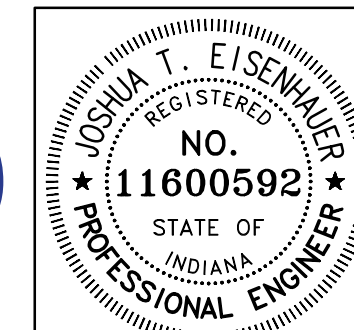
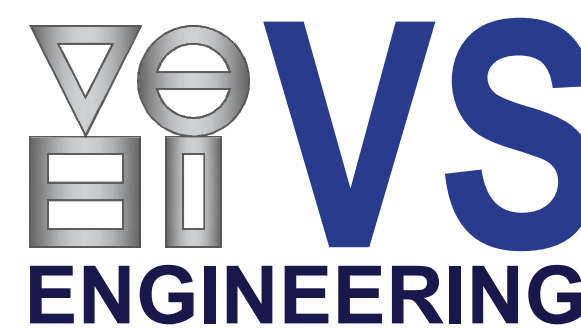

RECOMMENDED FOR APPROVAL *Joshua T. Eisenhauer* 11/18/2020
DESIGN ENGINEER DATE

DESIGNED: JTE DRAWN: TWS
CHECKED: MAH CHECKED: JTE

CITY OF BLOOMINGTON
W 6TH STREET & S ELM STREET SIDEWALK REPLACEMENT

TYPICAL SECTION

HORIZONTAL SCALE	BRIDGE FILE
1" = 4'	N/A
VERTICAL SCALE	CONTRACT
N/A	N/A
SURVEY BOOK	SHEETS
N/A	3 of 7
CITY PROJECT	VS PROJECT
	18-4002



DIRECTORY: F:\2018\18-4002 Bloomington On-Call\30 SheetDrawings\6th St. Sidewalks - N Elm to N Fairview Streets\
 FILE: 18-4002 PLANS.dwg
 DIMSCALE: 1/8" = 1' LTSCALE: 1/8"
 PLOTTED BY: TSegall
 DATE: Nov 19, 2020 - 11:36am

CONSTRUCTION LEGEND					
(A)	PCCP FOR APPROACHES, 6IN	(B)	DETECTABLE WARNING SURFACE, CAST IRON	(C)	CARRIAGE WALK, CONCRETE, 4"
(P)	HMA PATCHING	(P2)	TACK COAT	(F)	SIDEWALK, CONCRETE, 4"
(G)	CURB & GUTTER, CONCRETE				

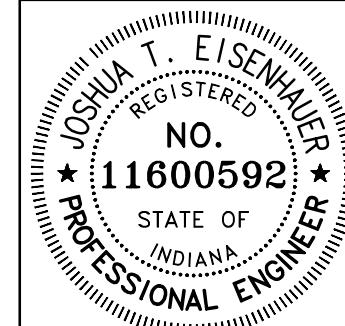
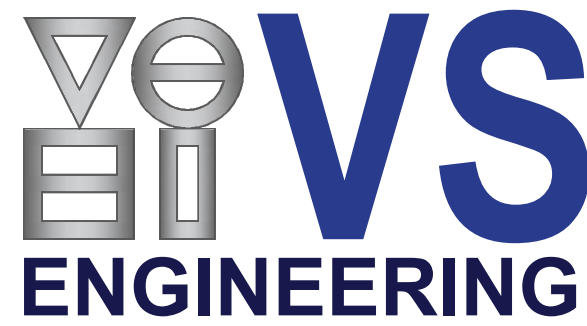

RECOMMENDED FOR APPROVAL	<i>Joshua T. Eisenhauer</i>	11/18/2020	
	DESIGN ENGINEER	DATE	
DESIGNED:	JTE	DRAWN:	TWS
CHECKED:	MAH	CHECKED:	JTE

CITY OF BLOOMINGTON	
W 6TH STREET & S ELM STREET SIDEWALK REPLACEMENT	
W 6TH STREET PLANS	
N ELM STREET TO N FAIRVIEW STREET	

HORIZONTAL SCALE	1" = 10'	BRIDGE FILE	N/A
VERTICAL SCALE	N/A	CONTRACT	N/A
SURVEY BOOK	N/A	SHEETS	4 of 7
CITY PROJECT	VS PROJECT		18-4002

DIRECTORY: F:\2018\18-4002 Bloomington On-Call\30 SheetDrawings\6th St Sidewalks - N Elm to N Fairview Streets\
 FILE: 18-4002 PLANS.dwg
 DIMSCALE: 1/8" = 1'-0"
 PLOTTED BY: TSegall
 DATE: Nov 19, 2020 - 6:04pm

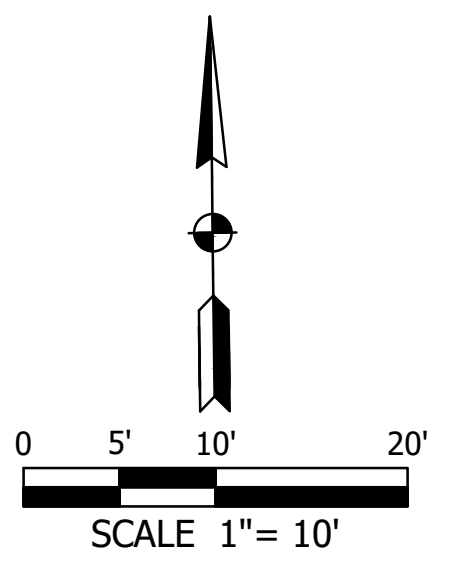
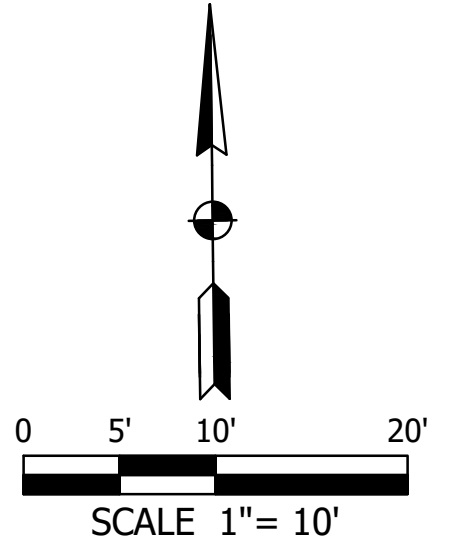
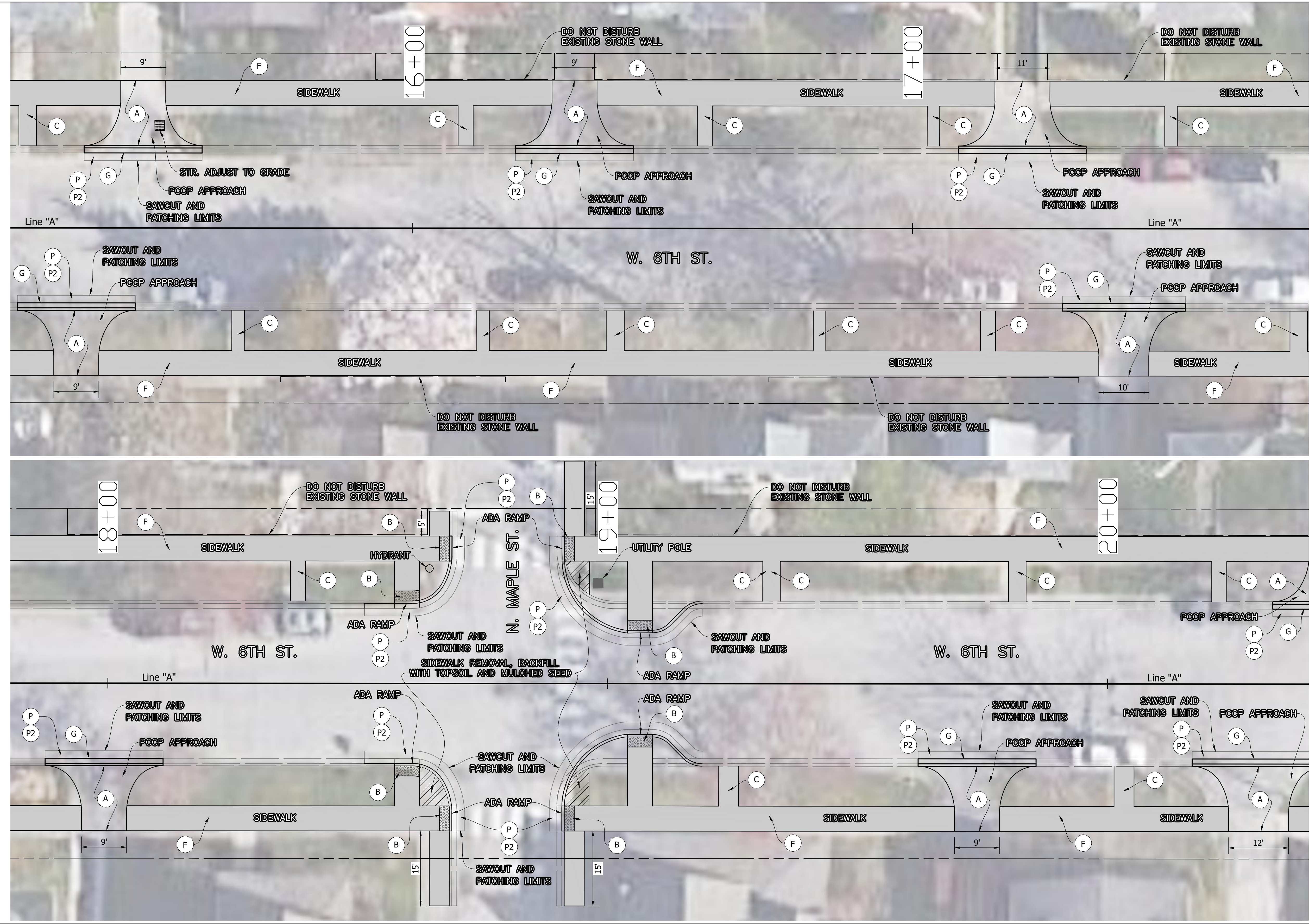

CONSTRUCTION LEGEND					
(A)	PCCP FOR APPROACHES, 6IN	(B)	DETECTABLE WARNING SURFACE, CAST IRON	(C)	CARRIAGE WALK, CONCRETE, 4"
(P)	HMA PATCHING	(P2)	TACK COAT	(F)	SIDEWALK, CONCRETE, 4"
(G)	CURB & GUTTER, CONCRETE				

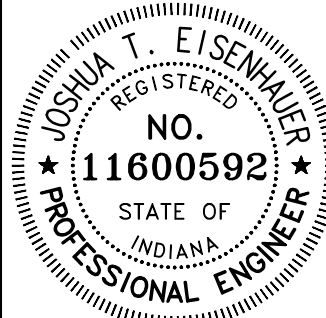
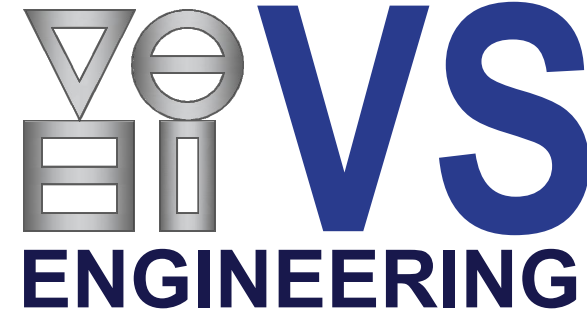

RECOMMENDED FOR APPROVAL	<i>Joshua T. Eisenhauer</i>	11/18/2020	DATE
DESIGNED:	JTE	DRAWN:	TWS
CHECKED:	MAH	CHECKED:	JTE

CITY OF BLOOMINGTON	
W 6TH STREET & S ELM STREET SIDEWALK REPLACEMENT	
W 6TH STREET PLANS	
N ELM STREET TO N FAIRVIEW STREET	

HORIZONTAL SCALE	BRIDGE FILE
1" = 10'	N/A
VERTICAL SCALE	CONTRACT
N/A	N/A
SURVEY BOOK	SHEETS
N/A	5 of 7
CITY PROJECT	VS PROJECT
	18-4002

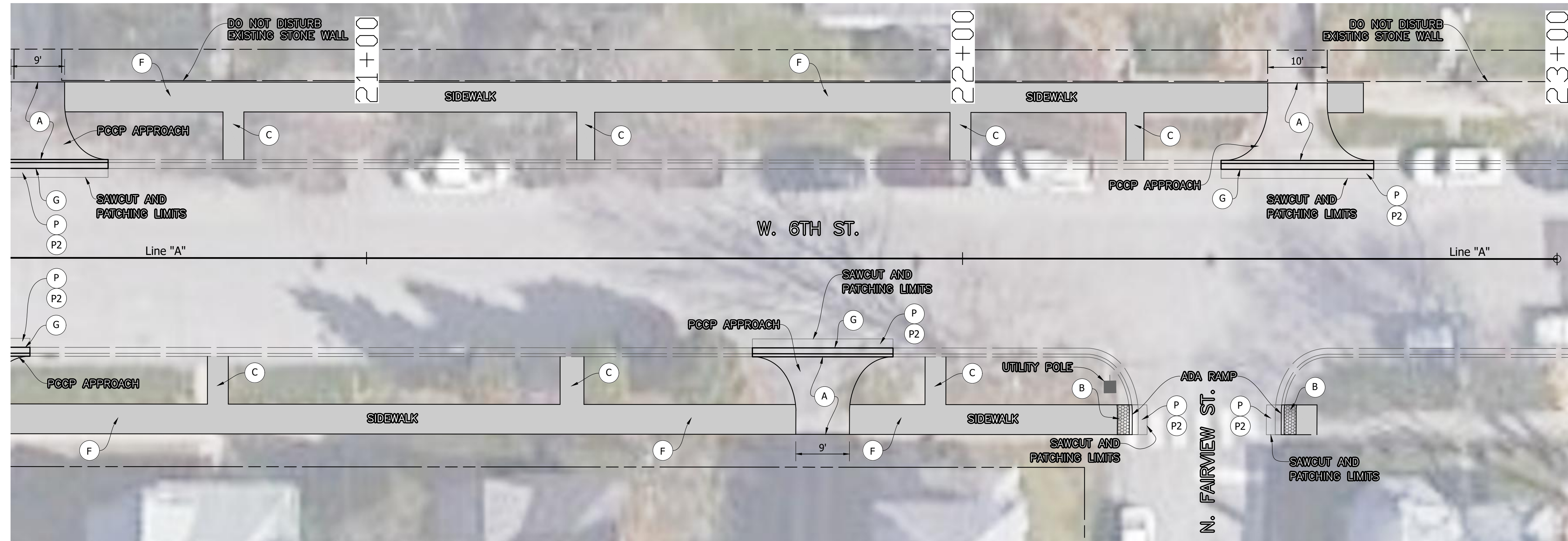
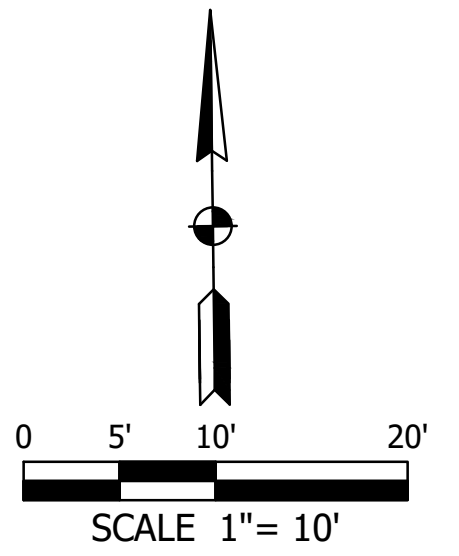

DIRECTORY: F:\2018\18-4002 Bloomington On-Call\30 SheetDrawings\6th St. Sidewalks - N Elm to N Fairview Streets\
 FILE: 18-4002 PLANS.dwg
 DIMSCALE: 1/4" = 10'
 PLOTTED BY: TSegall
 DATE: Nov 19, 2020 - 11:39am

CONSTRUCTION LEGEND		
(A) PCCP FOR APPROACHES, 6IN	(B) DETECTABLE WARNING SURFACE, CAST IRON	(C) CARRIAGE WALK, CONCRETE, 4"
(P) HMA PATCHING	(P2) TACK COAT	(F) SIDEWALK, CONCRETE, 4"
(G) CURB & GUTTER, CONCRETE		

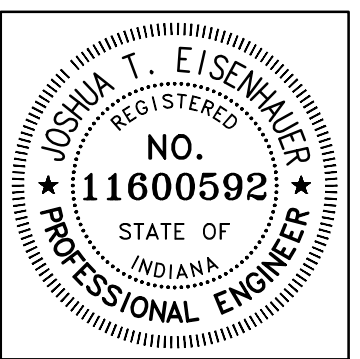
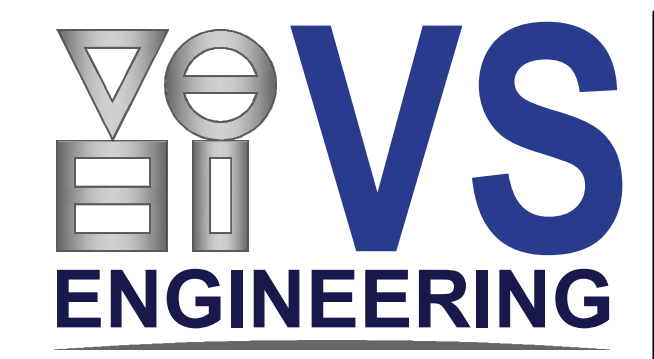

RECOMMENDED FOR APPROVAL	<i>Joshua T. Eisenhauer</i>	11/18/2020
	DESIGN ENGINEER	DATE
DESIGNED: JTE	DRAWN: TWS	
CHECKED: MAH	CHECKED: JTE	

CITY OF BLOOMINGTON	
W 6TH STREET & S ELM STREET SIDEWALK REPLACEMENT	
W 6TH STREET PLANS	
N ELM STREET TO N FAIRVIEW STREET	

HORIZONTAL SCALE	BRIDGE FILE
1" = 10'	N/A
VERTICAL SCALE	CONTRACT
N/A	N/A
SURVEY BOOK	SHEETS
N/A	6 of 7
CITY PROJECT	VS PROJECT
	18-4002

DIRECTORY: F:\2018\18-4002 Bloomington On-Call\30 SheetDrawings\6th St Sidewalks - N Elm to N Fairview Streets\
 FILE: 18-4002 PLANS.dwg
 DIMSCALE: 1/8"=1'-0"
 PLOTTED BY: TSegall
 DATE: Nov 18, 2020 - 4:40pm

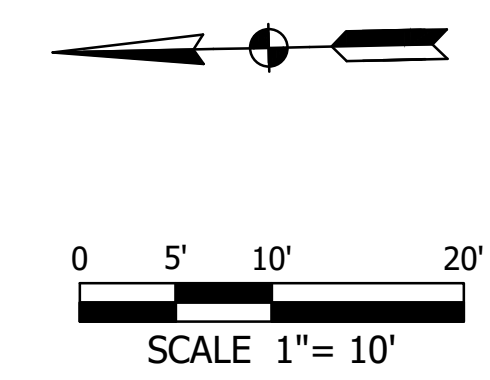
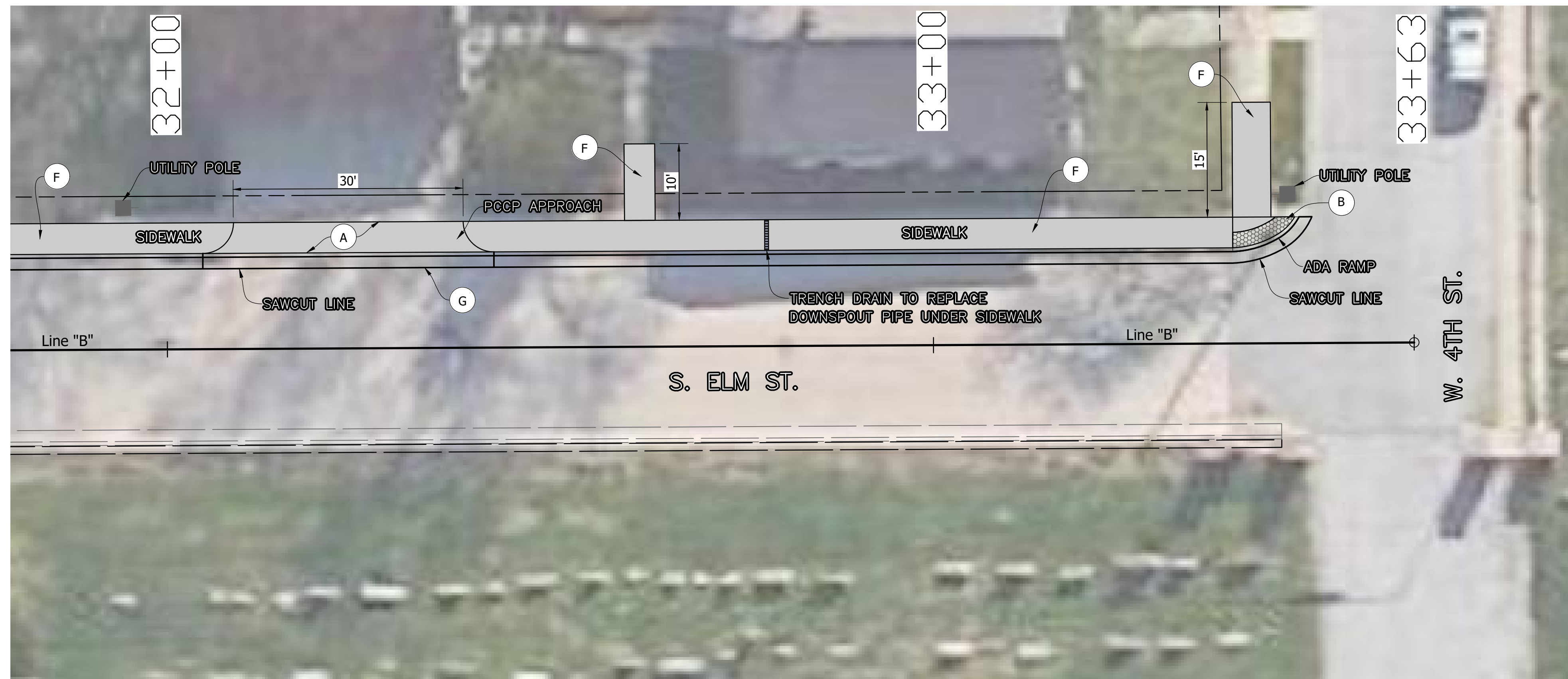
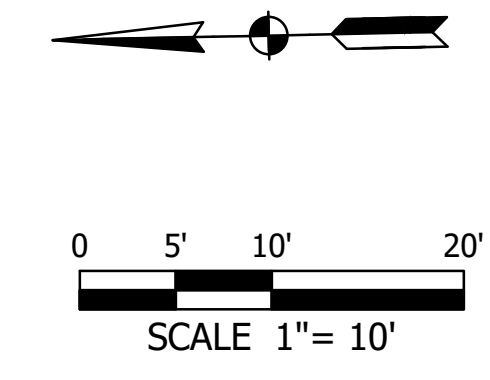

CONSTRUCTION LEGEND			
(A)	PCCP FOR APPROACHES, 6IN	(C)	CARRIAGE WALK, CONCRETE, 4"
(P)	HMA PATCHING	(F)	SIDEWALK, CONCRETE, 4"
(G)	CURB & GUTTER, CONCRETE	(B)	DETECTABLE WARNING SURFACE, CAST IRON
		(P2)	TACK COAT

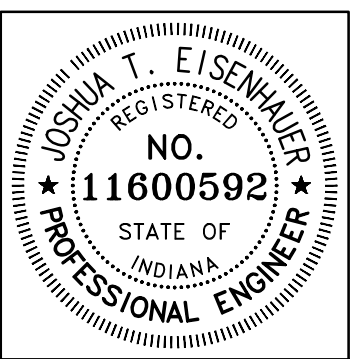
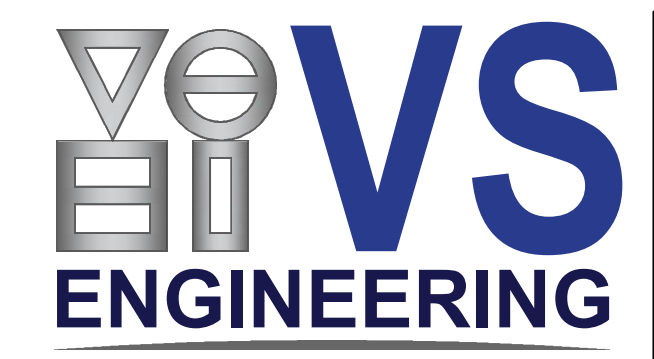

RECOMMENDED FOR APPROVAL	<i>Joshua T. Eisenhauer</i>	11/18/2020	DATE
DESIGNED:	JTE	DRAWN:	TWS
CHECKED:	MAH	CHECKED:	JTE

CITY OF BLOOMINGTON	
W 6TH STREET & S ELM STREET SIDEWALK REPLACEMENT	
S ELM STREET PLANS	
W KIRKWOOD AVE TO 4TH STREET	

HORIZONTAL SCALE	BRIDGE FILE
1" = 10'	N/A
VERTICAL SCALE	CONTRACT
N/A	N/A
SURVEY BOOK	SHEETS
N/A	7 of 7
CITY PROJECT	VS PROJECT
	18-4002